

RADIO & TELEVISION NEWS

JULY
1954

35 CENTS
In U. S. and Canada



World's Leading Electronics Magazine

IN THIS ISSUE

PIONEER AMATEUR STATION

A 85-WATT
"INFINITE FEEDBACK"
AMPLIFIER

A SIMPLE GEIGER COUNTER

INSTALLING A COLOR TUBE

2-METERS
IN THE FAMILY CAR

TROUBLESHOOTING
3-WAY PORTABLES

FUNDAMENTALS OF COLOR TV

THE CURVE THAT CONFORMS

AERIAL "PRIVATE EYE" ▶
TRACES TV SIGNALS

(See Page 43)



HN-24-15703-15
SHERMAN PARK BR LIBRARY
5065 EASTON AVE
ST LOUIS 13 MO

I WILL TRAIN YOU AT HOME FOR GOOD PAY JOBS IN RADIO-TELEVISION





J. E. SMITH has trained more men for Radio-Television than any other man... OUR 40th YEAR.

America's Fast Growing Industry Offers You Good Pay—Bright Future—Security

I TRAINED THESE MEN

 "Started to repair sets six months after enrolling. Earned \$12 to \$15 a week in spare time."—Adam Kramlik, Jr., Sunnyside, Pennsylvania.

 "Up to our necks in Radio-Television work. Four other NRI men work here. Am happy with my work."—Gen. Peterson, Bradford, Ont., Canada.

 "Am doing Radio and Television Servicing full time. Now have my own shop. I owe my success to N.R.I."—Curtis Stath, Ft. Madison, Iowa.

 "Am with WCOC. NRI course can't be beat. No trouble passing 1st class Radio-phone license exam."—W. Parker, Meridian, Mississippi.

 "By graduation, had paid for course, car, testing equipment. Can service toughest jobs."—E. J. Streitberger, New Boston, Ohio.

AVAILABLE TO VETERANS UNDER G.I. BILLS

Training plus opportunity is the PERFECT COMBINATION for job security, good pay, advancement. In good times, the trained man makes the BETTER PAY, GETS PROMOTED. When jobs are scarce, the trained man enjoys GREATER SECURITY. NRI training can help assure you more of the better things of life.

Start Soon to Make \$10, \$15 a Week Extra Fixing Sets

Keep your job while training. I start sending you special booklets that show you how to fix sets the day you enroll. Multitester built with parts I send helps you make \$10, \$15 a week extra fixing sets while training. Many start their own Radio-Television business with spare time earnings.

My Training Is Up-To-Date

You benefit by my 40 years' experience training men at home. Well illustrated lessons give you basic principles you need. Skillfully developed kits of parts I send (see below) "bring to life" things you learn from lessons.

You Learn by Practicing with Parts I Send



Nothing takes the place of PRACTICAL EXPERIENCE. That's why NRI training is based on LEARNING BY DOING. You use parts I furnish to build many circuits common to Radio and Television. As part of my Communications Course, you build many things, including low power transmitter shown at left. You put it "on the air," perform procedures required of broadcasting operators. With my Servicing Course you build modern Radio, etc. Use Multitester you build to make money fixing sets. Many students make \$10, \$15 week extra fixing neighbors' sets in spare time while training. Coupon below will bring book showing other equipment you build. It's all yours to keep.

The Tested Way To Better Pay!

2 FREE BOOKS SHOW HOW MAIL COUPON



Television Making Good Jobs, Prosperity—Even without Television, Radio is bigger than ever. 115 million home and auto Radios to be serviced. Over 3000 Radio broadcasting stations use operators, technicians, engineers. Government, Aviation, Police, Ship, Micro-wave Relay, Two-Way Radio Communications for buses, taxis, trucks etc., are important and growing fields. Television is moving ahead fast.

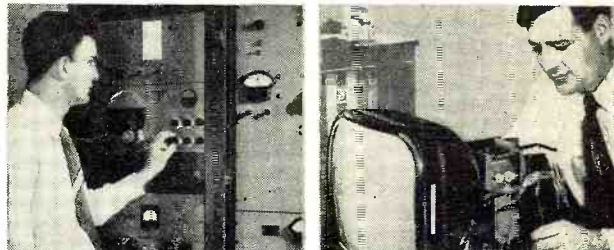

About 200 Television stations are now on the air. Hundreds of others being built. Good TV jobs opening up for Technicians, Operators, etc. 25 million homes now have Television sets. Thousands more are being sold every week. Get a job or have your own business selling, installing, servicing.

Radio-TV Needs Men of Action—Mail Coupon

Act now to get more of the good things of life. Actual lesson proves my training is practical, thorough. 64-page book shows good job opportunities for you in many fields. Take NRI training for as little as \$5 a month. Many graduates make more than total cost of training in two weeks. Mail coupon now. J. E. SMITH, President, National Radio Institute, Dept. 4GE, Washington 9, D. C. OUR 40TH YEAR.

Good for Both—FREE

MR. J. E. SMITH, President, Dept. 4GE
National Radio Institute, Washington 9, D. C.
Mail me Sample Lesson and 64-page Book, FREE.
(No salesman will call. Please write plainly.)

Name..... Age.....

Address.....

City..... Zone..... State.....

VETS write in date of discharge.....

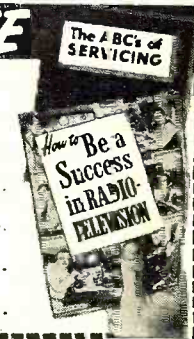

RADIO & TELEVISION NEWS is published monthly by Ziff-Davis Publishing Company, William B. Ziff, Chairman of the Board (1946-1953), at 64 E. Lake St., Chicago 1, Ill. Entered as second-class matter July 21, 1948, at the Post Office, Chicago, Ill., under the act of March 3, 1879. Authorized by Post Office Department, Ottawa, Canada, as second-class matter. SUBSCRIPTION RATES: Radio & Television News—one year U. S. and possessions, and Canada \$4.00; Pan-American Union countries \$4.50; all other foreign countries \$5.00. Radio-Electronic Engineering Edition—One year U. S. and possessions, and Canada \$6.00; Pan-American Union countries \$6.50; all other foreign countries \$7.00. Postmaster—Please return undelivered copies under form 3559 to 64 E. Lake St., Chicago 1, Ill.

Editor and Asst. Publisher
OLIVER READ, D.Sc., W1ETI

Managing Editor
WM. A. STOCKLIN, B. S.

Technical Editor
W. S. RENNE, M. S.

Service Editor
CHARLES TEPFER

Assistant Editors
P. B. HOEFER
M. C. MAGNA

Television Consultant
WALTER H. BUCHSBAUM

Short-Wave Editor
KENNETH R. BOORD

Art Editor
FRANK SAYLES

Draftsmen
A. A. GANS, W2TSP
J. A. GOLANKE

Advertising Manager
L. L. OSTEN

Midwest Adv. Manager
JOHN A. RONAN, JR.

Western Adv. Manager
JOHN E. PAYNE



COVER PHOTO: Part of the measuring equipment used by Tele-Beam Industries in making their aerial surveys to determine television station signal strength and service coverage. (Ektachrome by Peter J. Samerjan)

ZIFF-DAVIS PUBLISHING COMPANY

President
B. G. DAVIS

Vice-Presidents
M. J. MORGANROTH
M. H. FROELICH

Secretary-Treasurer
G. E. CARNEY

Circulation Manager
M. MICHAELSON

BRANCH OFFICES

CHICAGO (1)

64 E. Lake St., AN 3-5200

LOS ANGELES (14)

Stotler Center, 900 Wilshire Blvd., Mich. 9856

RADIO & TELEVISION NEWS

First in radio-
television-audio-electronics

Average Paid Circulation over 230,000

Radio News Trademark Reg. U. S. Pat. Office • Television News Trademark Reg. U. S. Pat. Office.

JULY, 1954

CONTENTS

From Catswhiskers to Color—An Editorial.....	Oliver Read	31
A Pioneer Amateur Station.....	Paul G. Watson	32
A Simple Geiger Counter.....	Dr. Harry R. Fechter & Dr. M. R. Boyd	35
Troubleshooting 3-Way Portables.....	James A. McRoberts	36
2 Meters in the Family Car.....	Walter S. Rogers, W1DFS	38
A 35-Watt "Infinite Feedback" Audio Amplifier.....	Charles P. Boegli	39
Aerial "Private Eye" Traces TV Signals.....		43
Elimination of R.F. Interference in Audio Systems (Part 2).....	Major Eugene F. Coriell, USAF	44
Installing a Color Picture Tube.....	Walter H. Buchsbaum	46
The Curve that Conforms.....		49
P.A. Rentals—A Profitable Sideline.....	Oliver Berliner	50
A Bass-Boost Control.....	Allan M. Ferres	52
1954 TV Receiver Specifications.....		54
TVI Troubleshooting (Part 3).....	Carl J. Quirk	55
Servicing Hi-Fi.....	David Fidelman	56
Certified Record Revue.....	Bert Whyte	58
Magnetic Recording 1888 to 1954.....	Leon A. Wortman	59
Fundamentals of Color TV—Chrominance Circuits (Part 5).....	Milton S. Kiver	60
Mac's Radio Service Shop.....	John T. Frye	66
The ARTSNY Story.....		68
Save That Rectifier.....	John P. Fath	70
New TV Stations on the Air.....		96
New TV Grants Since Freeze Lift.....		100
Radio-TV Service Industry News.....		112

DEPARTMENTS

Spot Radio News.....	12	What's New in Radio.....	82
Within the Industry.....	26	Technical Books.....	101
Short-Wave.....	K. R. Boord 64	New Audio Equipment.....	118
Manufacturers' Literature.....	126		

COPYRIGHT 1954
(All Rights Reserved)
ZIFF-DAVIS PUBLISHING COMPANY
WILLIAM B. ZIFF (1898-1953) FOUNDER
Editorial and Executive Offices
366 Madison Ave., New York 17, N. Y.
VOLUME 52 • NUMBER 1



Member
Audit Bureau of
Circulations

SUBSCRIPTION SERVICE: All communications concerning subscriptions should be addressed to Circulation Dept., 64 E. Lake St., Chicago 1, Ill. Subscribers should allow at least four weeks for change of address.
CONTRIBUTIONS: Contributors are advised to retain a copy of their manuscripts and illustrations. Contributions should be mailed to the New York Editorial Office and must be accompanied by return postage. Contributions will be handled with reasonable care, but this magazine assumes no responsibility for their safety. Any copy accepted is subject to whatever adaptations and revisions are necessary to meet the requirements of this publication. Payment covers all author's, contributor's, and contestant's rights, title, and interest in and to the material accepted and will be made at our current rates upon acceptance. All photos and drawings will be considered as part of the material purchased.

RADIO & TELEVISION NEWS

All Electronic Parts
YOURS TO KEEP!

Now!
Work over
300
practical projects
WITH THESE
PARTS...



MULTIMETER

....TO
HELP YOU LEARN

TELEVISION

RADIO-ELECTRONICS Now... at home in spare time you can get BOTH the very training and subsequent Employment Service you need to help you start earning real money in America's thrilling, multi-billion dollar opportunity field of Television-Radio-Electronics. Now that Television is coming to almost every community, here is a chance of a lifetime to prepare to cash in on one of Television's great expansions.

D.T.I.'s amazingly practical home method enables you to set up your own HOME LABORATORY. You get many Electronic parts which you mount on individual bases with spring clip connectors. Tops for experimenting! Add or remove parts in a jiffy. No wasted hours of soldering and unsoldering for each project. You spend minimum time to get maximum knowledge of important circuits that really work. In fact, you get exactly the same type of basic training equipment used in our Chicago training laboratory—one of the nation's finest.

Build and KEEP This VALUABLE TEST EQUIPMENT

Your home laboratory projects also include building and keeping a versatile 5 inch Oscilloscope and precision Jewel Bearing Multi-Meter. These quality commercial test instruments help you EARN WHILE YOU LEARN and will prove mighty valuable, should you later decide to start your own full time TV-Radio service business. You also build and keep a quality 21 inch TV SET.

D.T.I. Provides EVERYTHING YOU NEED to master TELEVISION

In addition to your home laboratory and easy-to-read lessons, you even use HOME MOVIES—a wonderfully effective and exclusive D.T.I. training advantage. You watch hidden actions... see electrons on the march. Important fundamentals... become "movie clear," helping you learn faster... easier... better.

Full time Residential training in D.T.I.'s great Chicago laboratories also available. MAIL COUPON TODAY for all facts. (If subject to Military Service, you'll especially welcome the information we have for you.)

D.T.I.'s Training is available in Canada



89 WAYS TO EARN MONEY

MAIL COUPON TODAY!

DEVRY TECHNICAL INSTITUTE

4141 BELMONT AVE., CHICAGO 41, ILL. DEPT. RN-7-K

I would like your valuable information-packed publication showing how I can get started toward a good job or my own business in Television-Radio-Electronics.

Name _____ Age _____

Street _____ Apt. _____

City _____ Zone _____ State _____



"ONE OF AMERICA'S FOREMOST TELEVISION TRAINING CENTERS"

DEVRY TECHNICAL INSTITUTE

AFFILIATED WITH

DEFORREST'S TRAINING, INC.

CHICAGO 41, ILLINOIS

It's no secret

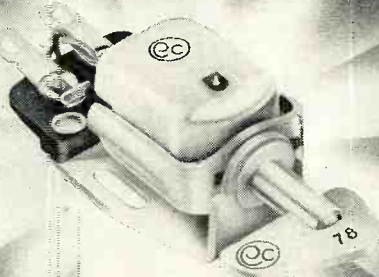

Professionals use Pickering MAGNETIC Cartridges

You're in the best of company if you use a Pickering MAGNETIC Cartridge. You have this in common with:

1. Leading record companies who use Pickering Cartridges for quality control.
2. Leading FM/AM good music stations and network studios.
3. Leading manufacturers of professional equipment for radio stations, recording studios, wired music systems and automatic phonographs, who install Pickering Cartridges for the maximum performance of their equipment.

Why Pickering MAGNETIC Pickups are the Choice of Recording and Broadcast Engineers!

"All modern disc recordings are made with MAGNETIC cutters. Within the geometrical and mechanical limitations of recording and reproducing equipment, a Pickering Pickup will re-generate an exact replica of MAGNETIC cutter response to the original program of music, speech or sound. This is a fundamentally inherent characteristic of the Pickering Pickup, supported by basic electromagnetic theory and countless

precise laboratory measurements. This is why Pickering MAGNETIC Pickups provide the most nearly perfect coupling possible, between reproducing equipment and original program. This is why they sound cleaner ... less distorted.

"Through the medium of the disc material, the reproducing system is effectively driven by the cutter electrical response itself."



PICKERING and company incorporated • Oceanside, L. I., New York

PICKERING PROFESSIONAL AUDIO COMPONENTS

"For those who can hear the difference"

... Demonstrated and sold by Leading Radio Parts Distributors everywhere. For the one nearest you and for detailed literature write Dept. C-5.

RADIO & TELEVISION NEWS



**Better Contrast!
Longer Life!
Availability!**

SYLVANIA
*Aluminized
Picture Tubes*
**ARE PACKED
WITH PROFITS!**

Make old sets like new... have more satisfied customers!

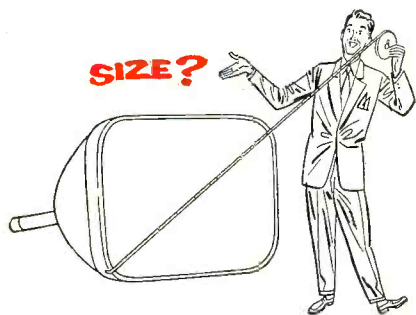

Interested in new sales records? You'll be heading in that direction when you replace old picture tubes with new Sylvania Aluminized Tubes.

Sylvania Aluminized Picture Tubes give terrific performance. They make old sets better and brighter than new by providing whiter whites—blacker blacks... a 6-times better picture contrast.

Sylvania Aluminized Picture Tubes are now available in most sizes for all popular TV sets. In other words, with Sylvania Aluminized Picture Tubes, you give your customers the best possible buy *and* the best possible service, including a full one-year warranty.

Remember, millions of set owners see and hear about Sylvania Picture Tubes on the nation-wide weekly television show "Beat The Clock." They know that they are famous for quality and dependability. For full details about aluminized tube replacement, write for Sylvania's "Aluminized Picture Tube Replacement Guide." Address: Dept. 4R-3507, Sylvania NOW!

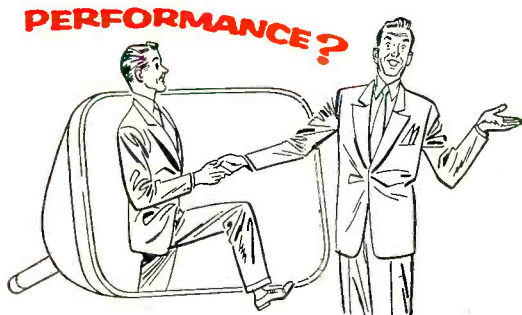
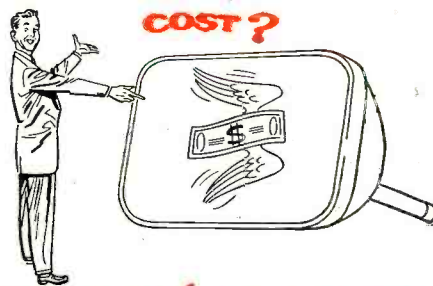

SYLVANIA

Sylvania Electric Products Inc.  1740 Broadway, New York 19, N. Y.

In Canada: Sylvania Electric (Canada) Ltd.
University Tower Building, St. Catherine Street, Montreal, P. Q.

LIGHTING • RADIO • ELECTRONICS • TELEVISION

FROM FIRST TO FOREMOST

50 Years of Setting Standards

Ray L. Triplett with the first commercial tube tester—a Triplett production—and Triplett Model 3423, the leading tube tester of today and tomorrow. See it at your parts jobber. Model 3423 Mutual Conductance Tube Tester. Dealer's net \$199.50

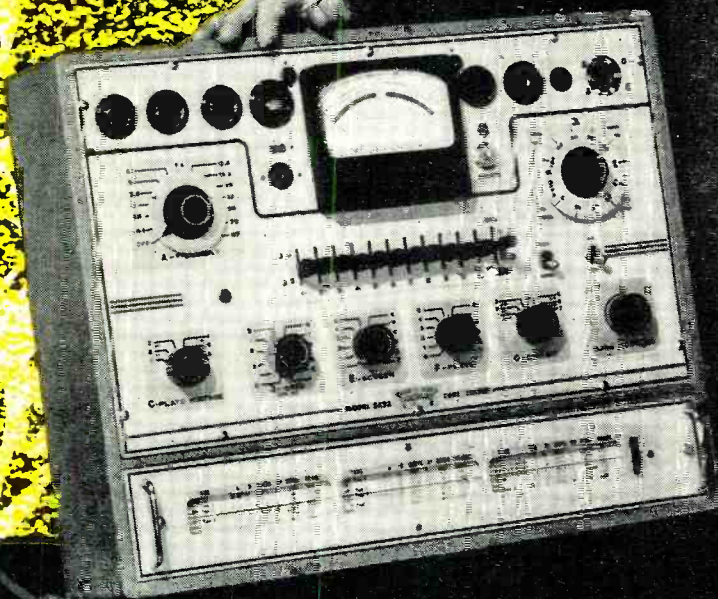

The only tube tester designed with 50 years experience. Two important lessons are learned, from experience, by the manufacturer of test equipment. First, the value of test equipment to a service man is in direct proportion as it reduces his necessary labor and increases his profit for the same span of work time. Model 3423 will give you no false readings to waste time—the patented circuit for tube testing employs actual signal (4KC) for grid signal. It also has a complete coverage of all tube types—six plate voltages (including 0-10 variable). Micromh's scales read 0-1800, 0-6 000, 0-18,000 and 0-36,000.

Secondly, test equipment costs money, and the purchaser must be protected against quick obsolescence. In Model 3423 the multiple switches allow making any combination of tube connections and is protection against such obsolescence.

Ask your jobber to demonstrate the many other extra features of this tester.

Only Triplett offers you a ten day free trial on all test equipment.

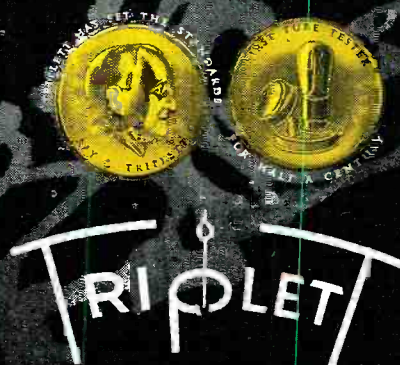

Electrical Instrument Co
Bluffton, Ohio

ADVANCE! Raise your earning power—learn RADIO-TELEVISION-ELECTRONICS by SHOP-METHOD HOME TRAINING

GOOD JOBS AWAIT THE TRAINED RADIO-TV TECHNICIAN

There is a place for *you* in the great Radio-Television-Electronics industry when you are trained as National Schools will train you at home!

Trained technicians are in growing demand at good pay—in manufacturing, broadcasting, television, communications, radar, research laboratories, home Radio-TV service, and other branches of the field. National Schools Master Shop-Method Home Training, with newly added lessons and equipment, trains you in your spare time, right in your own home, for these fascinating opportunities. **OUR METHOD IS PROVED BY THE SUCCESS OF NATIONAL SCHOOLS TRAINED MEN, ALL OVER THE WORLD, SINCE 1905.**

EARN WHILE YOU LEARN

Many National students pay for all or part of their training with spare time earnings. We'll show you how you can do the same! Early in your training, you receive "Spare-time Work" Lessons which will enable you to earn extra money servicing neighbors' and friends' Radio and Television receivers, appliances, etc.



Signal Generator

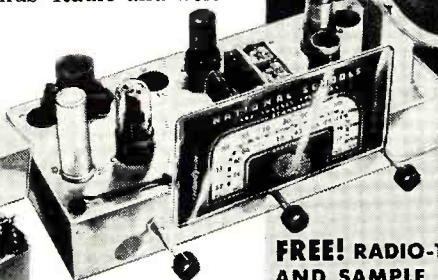

T. R. F. Receiver

Audio Oscillator

National Schools Training is All-Embracing

National Schools prepares you for your choice of many job opportunities. Thousands of home, portable, and auto radios are being sold daily—more than ever before. Television is sweeping the country, too. Co-axial cables are now bringing Television to more cities, towns, and farms every day! National Schools' *complete* training program qualifies you in all fields. Read this partial list of opportunities for trained technicians:

Business of Your Own • Broadcasting
Radio Manufacturing, Sales, Service • Telecasting
Television Manufacturing, Sales, Service
Laboratories: Installation, Maintenance of Electronic Equipment
Electrolysis, Call Systems
Garages: Auto Radio Sales, Service
Sound Systems and Telephone Companies, Engineering Firms
Theatre Sound Systems, Police Radio
And scores of other good jobs in many related fields.

TELEVISION TRAINING

You get a complete series of up-to-the-minute lessons covering all phases of repairing, servicing and construction. The same lesson texts used by resident students in our modern and complete Television broadcast studios, laboratories and classrooms!



MASTER ALL PHASES!

Get Master Shop-Method Home Training from an Established Practical Resident School with its own Training Shops, Laboratories, Studios — almost 50 Years of Successful Experience in Training Ambitious Men.
We Bring National Schools To You!



You also receive this Multitester



Superheterodyne Receiver

LEARN BY DOING

You receive and keep all the modern equipment shown above, including tubes and valuable, professional quality Multitester. *No extra charges.*

FREE! RADIO-TV BOOK AND SAMPLE LESSON!

Send today for National Schools' new, illustrated Book of Opportunity in Radio-Television-Electronics, and an actual Sample Lesson. No cost—no obligation. Use the coupon now—we'll answer by return airmail.

APPROVED FOR
VETERANS
AND
NON-VETERANS
Check coupon below

Both
Resident and
Home Study
Courses Offered!



NATIONAL SCHOOLS

LOS ANGELES 37, CALIFORNIA • ESTABLISHED 1905
IN CANADA: 811 W. HASTINGS STREET, VANCOUVER, B.C.

GET FACTS FASTEST! MAIL TO OFFICE NEAREST YOU!

(mail in envelope or paste on postal card)

NATIONAL SCHOOLS, Dept. RH-74

4000 S. Figueroa Street or 323 West Polk Street
Los Angeles 37, Calif. or Chicago 7, Ill.

Send FREE Radio-TV Electronics book and FREE sample lesson. No obligation, no salesman will call.

NAME _____ BIRTHDAY _____ 19 _____

ADDRESS _____

CITY _____ ZONE _____ STATE _____

Check here if interested in Resident School Training at Los Angeles.
VETERANS: Give Date of Discharge _____

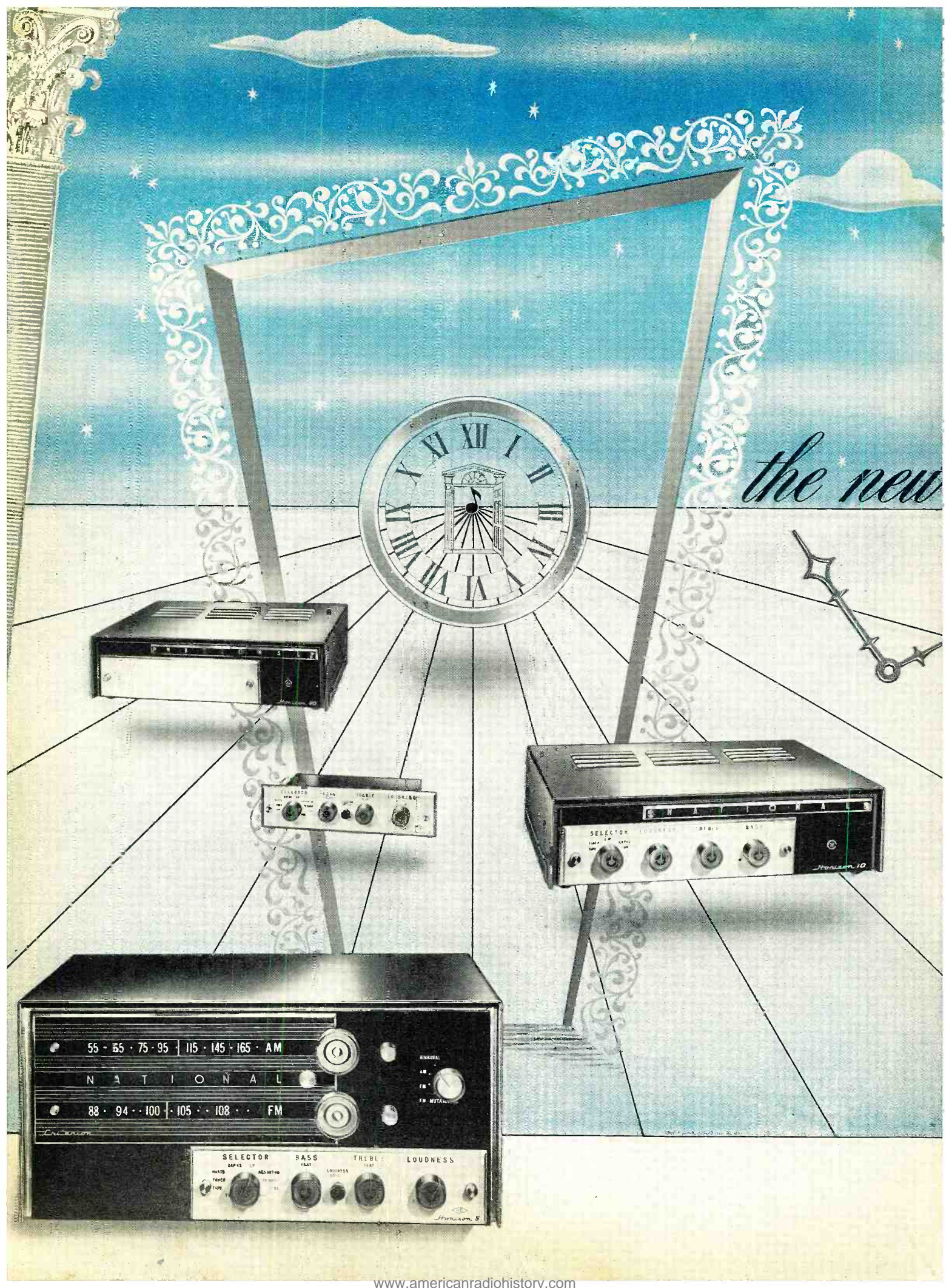

the new

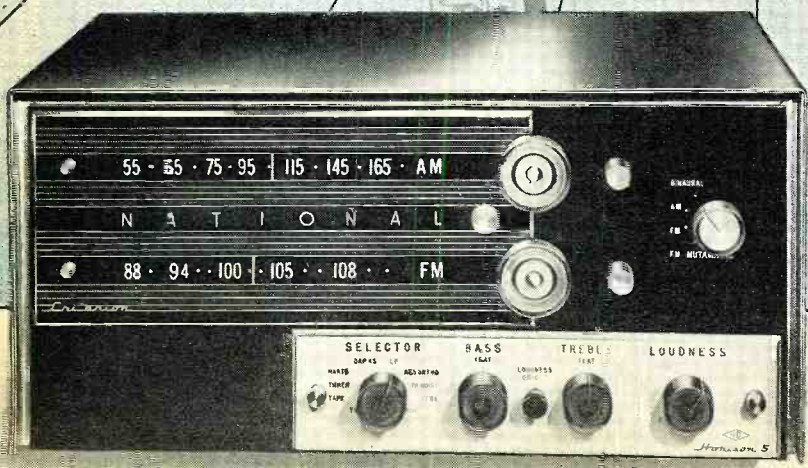
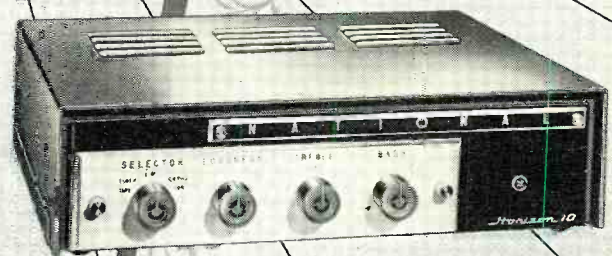
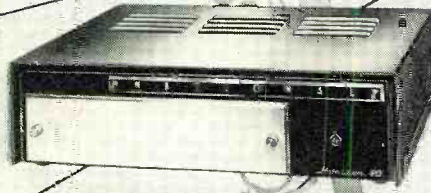

Now, National — world's most respected maker of professional radio receiving equipment — brings you a new concept in high-fidelity!

For 40 years, National has designed and manufactured extremely critical circuits for the armed forces (9 out of 10 Navy ships are equipped with National receivers), for the world's largest airports, for communication services, industry, radio amateurs and all those who demand optimum reception even under the most adverse operating conditions.

Only this hard core of *radio* experience could produce the New "Criterion" AM-FM Tuner, the *heart* of National's new HORIZON line in high fidelity!

HORIZON *line in high fidelity*



On the entire line, National has lavished all the advanced engineering techniques and latest research available.

The result is an integrated high-fidelity system so unique in circuitry, so far ahead in performance and styling, it obsoletes present equipment on the market today!

Look for the new HORIZON line at your high fidelity headquarters *this* month! Meantime, write for complete specifications to Dept. RN 754, National Co., Inc. Malden, Mass.



HORIZON 20 20-Watt Amplifier

Incorporates a revolutionary new National circuit featuring "unity coupling" — first major improvement in amplifier design since the Williamson circuit! **\$84.95**



HORIZON 5 Preamplifier-Control Unit

Lowest distortion (less than 1%) at highest output (15 volts). Distortion virtually unmeasurable at 1.5 volts output. Compensation for choice of 7 recording characteristics. Unique bass and treble controls permit compensation for speaker deficiencies and suppression of turntable rumble without affecting middle range. **\$49.95**

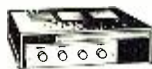

HORIZON 10 10-Watt Amplifier

The National "unity-coupled" circuit — new amplifier standard — in a 10-watt amplifier. Incorporates built-in preamplifier and complete equalization and tone control networks. **\$79.95**



HORIZON "Criterion" AM-FM Tuner

Simultaneous AM and FM reception with separate volume and tuning controls for individual or binaural listening. Exclusive new Mutamatic Tuning eliminates all hiss and noise between FM stations — stations come in out of velvety silence, stay locked in. **\$169.95** (*less pre-amp*)

tuned to tomorrow  **National**

**NEWEST
FASTEST SELLER
in the field!**

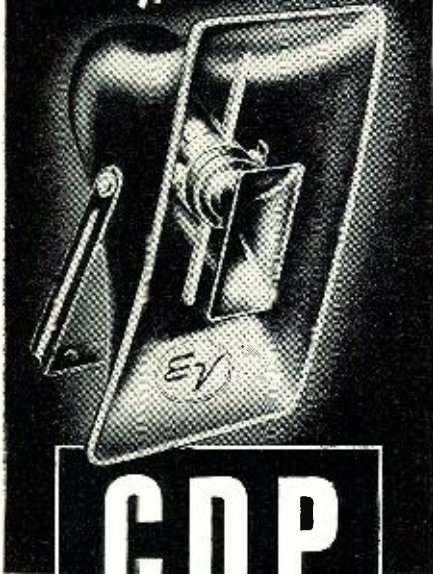

**CDP
COMPOUND
DIFFRACTION
PROJECTOR**

**Public Address
Loudspeaker System**

**setting new standards for
VOICE PENETRATION
AND MUSICASTING**

- Greatly outperforms comparably sized reentrant horns
- Tremendous penetrating power and coverage at very low unit energy cost
- Exclusive E-V coaxial design and diffraction principle
- Peak-free response ± 5 db to 10,000 cps.
- Delivers $2\frac{1}{2}$ octaves more musical range
- Weather-proof, blast-proof, splash-proof. Virtually indestructible.

Model 843 CDP. 25 watts. 16 ohms.
List Price, \$69.50 Net, \$41.70

**COMPARE
POLAR PATTERN**
Sound distribution of CDP exceeds 120° at all frequencies up to 10,000 cps.

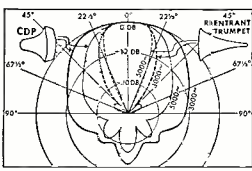

**COMPARE
RESPONSE AND
EFFICIENCY**
Note extended high frequency range of CDP. Response is smooth, peak-free ± 5 db to 10,000 cps.

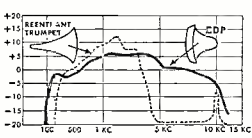

Write for Free
Bulletin No. 197

*Pat. Pend.

Electro-Voice

410 CARROL ST. • BUCHANAN, MICHIGAN
Export: 13 E. 40th St., New York 16, U. S. A. Cables: Arlab

Spot Radio News

★ Presenting latest information on the Radio Industry.

By RADIO & TELEVISION NEWS'
WASHINGTON EDITOR

THE BRIGHT HOPES, forecast for the ultra-highs, (which began to lose some of their iridescent luster a few months ago when v.h.f. power boosts began sprawling signals over to areas earmarked for the high-band channels, network ties became more difficult to obtain, and low powers stumped u.h.f. coverage and audience appeal) were routed to the witness stand in Washington, in the late Spring, during one of the most unusual technological trials ever authorized. Here, for the first time, a Congressional body sought to find out why these new channels were in such trouble and what might be done to help.

Under the skilled guidance of Senator Charles Potter, members of an ultra-high association, telecasters, network operators, and even manufacturers set up a plan to review the variables that obtain on the higher bands and what might be applied as a practical solution.

As the trial convened, the number of upstairs-station casualties continued to grow. WTAC-TV in Flint reported that they had to suspend operations because ad agencies and advertisers refused to accept the station, and this despite a 62 per-cent conversion rate in that city. According to the general manager of the station, the agencies and sponsors have just developed a "blanket aversion" to the use of a u.h.f. outlet if a v.h.f. station covers the market, even with an inadequate signal. It was noted that the Flint station had begun operating from a new \$125,000 building on Thanksgiving Day, 1953, and had been losing a minimum of \$10,000 a month, even though it was affiliated with ABC. The low-band signals, causing the economic problem, come from Detroit, Lansing, and Bay City.

In Atlantic City, WFPG-TV also reported it had run into trouble and was temporarily suspending operations, until Washington and others could provide a satisfactory solution. A statement released by management said that the station had, with the advent of superpower, lost 33 half-hours weekly of network and other top-notch programs. The program cancellations were received because the high-power metropolitan market v.h.f. stations 60 miles from Atlantic City had established a concept of coverage generally satisfying TV viewers. Con-

tinuing, the complaint added: "Therefore, extreme audience and economic loss compels suspension at this time, because WFPG-TV cannot now render a service of pride to the south Jersey area, for which it was planned, built, and dedicated."

St. Louis was also up in arms over the grant of a low-band permit to a second station owned by a newspaper. It was felt that this new grant would seriously upset ultra-high interest. The area had been assigned channels 14, 30, 36, 42, and 54, but because of economic problems 30 and 42 were not on the air, and 14 went off the air because the operators couldn't obtain network programs. Commenting on the upheaval caused by the low-band approval, one association spokesman said that the Commission must do something to prevent failure of the high-band system, and keeping new low-band operators off the air until u.h.f. is firmly established is one answer.

Spartanburg, South Carolina, was also faced with a problem, according to the operators of two u.h.f. stations in that area. The condition appeared when the Commission permitted a station to shift its channel to 7 and move its transmitter atop a mountain. The u.h.f. owners claimed that this move hit their market, since the new site and channel will provide a stronger signal over the areas they now serve. The majority of the Commission held that the high-band owners advanced no substantial reasons against the change; the economic-injury allegations were called purely speculative. However, Madame Commissioner Frieda Henneck disagreed with her colleagues, and asked for a further inquiry. She felt that the shift would affect the high-band stations, for it . . . "will bring into these two markets another competitor for the advertising revenue, and will seriously curtail the conversion of sets to receive u.h.f. programs."

The Commission received one proposal for a solution to the u.h.f. snarl from a California attorney. Recommended was the establishment of a subscription TV service restricted to u.h.f.; permission to telecast stills with sound for more than one hour daily, to give dealers and technicians more time to work with u.h.f. sets and converters; a requirement that networks

big values

new releases

send for ALLIED'S Latest Free Supplement

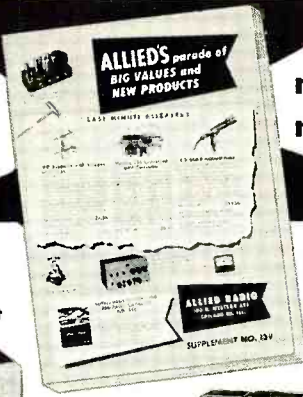

Popular Knight Portable Radio Build-Your-Own Kit



It's easy to build this powerful 3-way superhet portable for AC, DC or battery operation. Tunes 535-1650 kc broadcast band; has built-in antenna, printed-circuit audio, large PM speaker, handsome carrying case. Easy to assemble from illustrated manual. High quality kit includes all parts, tubes and case (less batteries). Shpg. wt., 6 lbs. 83 5730. *Only*.....\$18.75
80 J651. Battery Kit. *Only*.....\$2.74

Knight Super-Thin Portable Radio



An ideal battery-operated personal portable, hardly thicker than a book. Advanced superhet circuit features low-draw tubes for 100 hours of battery life. Includes built-in loopstick antenna, PM speaker, easy-tuning thumbwheel controls, automatic volume control. Develops surprising power and wonderful tone quality. Housed in beautiful red plastic case, 6 x 9 x 2 1/4" deep. With tubes (less batteries). Shpg. wt., 4 lbs. 54K717. *Only*.....\$17.95
80 J651. Battery Kit. *Only*.....\$2.74

Sav-A-Battery Rejuvenator—Plays Portables from A.C.

Permits the operation of portable radios using single 1 1/2 v. "A" and single 67 1/2 v. "B" batteries from AC outlet. Fits into battery compartment of set. Also serves as "B" battery rejuvenator. Easy to install. 3 3/8 x 2 3/8 x 1 1/4". For 105-125 v., 50-60 cycles AC. Shpg. wt., 1 1/4 lbs. 80 P 190. *Only*.....\$5.85



Speedway Heavy-Duty Electric Drill

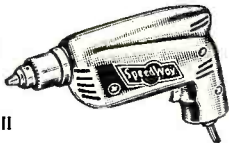

Exceptional value in a powerful, well-balanced drill. Has 1/4" gear-type chuck with key. Heavy-duty universal series-wound motor; self-aligning ball thrust bearings; trigger switch. No-load speed, 2400 rpm; full load, 1500 rpm. Capacity in steel, 1/4"; in hardwood, 1/2". Overall length, 9". U.L. approved. For 110-120 v., AC or DC. Shpg. wt., 4 1/2 lbs. 46 N 360. *Only*.....\$14.33



Ward Economy Auto Aerials

Low-cost top cowl auto antenna. Fits any model car; easily and quickly installed completely from outside of car. Has 3 sections; telescopes to 56". Of sturdy, durable tubing; chrome-plated; with "8-ball" mounting insulator. Complete with 36" high-"Q" lead-in and coaxial-type connector. A value sensation; makes an ideal auto aerial replacement. Shpg. wt., 1 lb. 92 CX 000. *Only*.....\$2.32
92 CX 001. As above, but with 54" lead-in. *Only*.....\$2.54

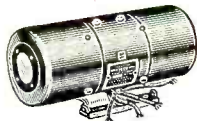

PE-101-C Dynamotor Buy

Brand-new government surplus unit for mobile Hams, etc., at sensational low cost. Ruggedly built. For cars with 6-volt or 12-volt electrical systems. With 12 v. DC input, delivers 610 v. DC at 150 ma and 325 v. DC at 125 ma. With 6 v. input, delivers 300 v. DC at 90 ma and 180 v. DC at 110 ma. Complete with conversion instructions. Dia., 4"; length after conversion, 10 1/2". Shpg. wt., 12 lbs. 80 P 195. *Only*.....\$4.95

Inter-Matic Time Switch

Ideal for control of room air conditioners, etc. SPST type; turns equipment on or off once in 24 hours; minimum time between settings, 1 hour. Manual operation won't interfere with settings. Handles 4000 watt load or 1 hp motor. Gray steel case with knockouts. 5 x 3 x 7 1/8". U.L. approved. For 105-125 v., 60 cycle A.C. Shpg. wt., 4 lbs. 78 B 322. *Only*.....\$7.12
78 B 323. Adapter Kit to make above unit portable. Consists of 6-ft. cord, plug, etc. Shpg. wt., 1 lb. *Only*.....98¢



New Fisher "50" Horn Speaker Enclosure

Deluxe enclosure for use with any 12" or 15" speaker system, single, 2-way, coaxial or tri-axial type. Compact, beautiful, flexible. Features: smooth response to below 30 cps; air loading of bass output reduces speaker distortion and increases power-handling capacity; substantially extends lower bass range; non-resonant design eliminates synthetic or "tuned" bass. Size: 37" h, 25" w, 20 1/8" d. 90 lbs. 81 DX 710. Dark Mahogany. *Net*.....\$129.50
81 DX 711. Korina Blonde. *Net*.....\$134.50

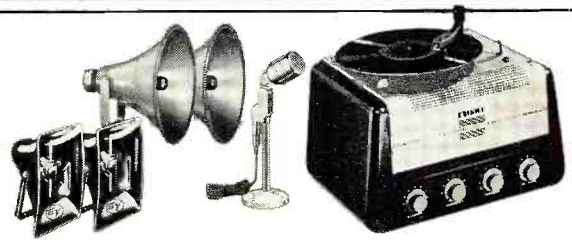

Knight 25-Watt 6V-110V P.A. System—A Top Value!

Here it is—a terrific value in a Universal P.A. System—for election campaigns, for any application requiring powerful indoor or outdoor amplification. Covers up to 85,000 square feet. Operates anywhere—from 110-130 v., 50-60 cycles AC or from any 6-volt auto storage battery. Features: 2 high impedance mike inputs; 1 phono input; optional record player; 25 watts *usable* output guaranteed; response 40-15,000 cps, ± 2 db; 2 speaker outlets—wide selection of impedances; tone control; separate volume controls for mikes and phono; built-in 6-volt-110 volt power supply; amplifier guaranteed unconditionally for one full year; U.L. Approved. System includes: Knight 25-Watt Universal amplifier with tubes; AC and 6-volt cables; 2 University PH all-metal reflex trumpets complete with 25-watt driver units; E-V mike, table stand, 20-ft. cord and plug; 50-ft. speaker cable. (Less phono top.) Shpg. wt., 140 lbs. 93 5X 632. Complete System. *Only*.....\$182.50
WITH ELECTRO-VOICE PROJECTORS. As above, but with two E-V 848 compound diffraction projectors in place of University trumpets. Features extended frequency response. 93 5X 635. *Only*.....\$182.50
3-SPEED PHONO TOP. Plays 78, 33 1/4 and 45 rpm records. Highest quality; with turnover crystal cartridge. 93 5X 640. *Only*.....\$17.45

Best Buy Knight Push-Button Tape Recorder Top Recorder Value—NOW with Remote Control Provision



Latest model—acclaimed "best buy" by recording fans. Five push-buttons select all operating functions: fast forward, playback, stop, record and fast reverse. Now with provision for remote control. Takes up to 7" reels. Two-speed dual-track for wide range of recording times. At 3.75" per second, 7" reel records for 1 hour—and additional hour on second half of tape; at 7.5" per second, records 1/2 hour continuously, 1 hour overall. 7" reel rewinds in 3 minutes. Response: ± 3 db from 75-8500 cps at 7.5" speed; 80-6000 cps at 3.75" speed. Efficient erase system; "lock" prevents accidental erase. Features: two neon recording level indicators. 2-watt built-in amplifier; 5 x 7" oval speaker. Records from mike, radio, tuner or phono. Handsome 2-tone portable case, 14 x 12 x 9". Complete with mike, take-up reel and 600-ft. roll of tape. For 110-120 v., 60 cycles AC. U.L. Approved. Shpg. wt., 29 lbs. 96 RX 675. *Only*.....\$104.50
REMOTE CONTROL. For remote starting and stopping of recorder. 18-ft. cable and plug. 2 x 3 x 3". Shpg. wt., 3 lbs. 96 R 636. *Only*.....\$6.64

Special Value Knight Recording Tape

Top-quality, highly dependable 1/4" recording tape at exceptionally low cost. Plastic base, smoothly coated with red oxide. Manufactured to meet rigid specifications. Features very low noise level, uniform output, and excellent response characteristics. Type "A". 96 R 698. 600 feet. *Net each*, \$1.37. 5 or more, *each*....\$1.24
96 R 699. 1200 feet. *Net each*, \$2.10. 5 or more, *each*....\$1.89



New Centralab Compentrol—Improves Tone Quality

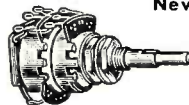

Dual shaft combination volume control and tone compensator—assures full range music, even at low volume levels. Accentuates bass and treble as volume is reduced. Level-set feature "customizes" control for individual room acoustics. For hi-fi amplifiers, radios, TV sets, etc. 30 M 436. *Only*.....\$4.41

ALLIED RADIO CORP., Dept. I-G-4
100 N. Western Ave., Chicago 80, Ill.

FREE Supplement

Send FREE ALLIED Supplement No. 139.

Enter order for.....

.....\$.....enclosed.

Name.....

Address.....

City.....Zone.....State.....

ALLIED RADIO

200 POUNDS
 on a 10 foot television mast
PERMA-TUBE supports it safely!

Place a 10 foot length of 1¼" x 16 gage (.065") wall Perma-Tube between two tables so that 6 inches rests on a table at each end. Place a 200 pound weight at the center point.

What happens? Tests prove that Perma-Tube will support this 200 pound weight with a minimum of deflection and permanent set.

Other materials show serious degrees of permanent set. Why? Because they are not made from the special strength J&L steel that is used to form Perma-Tube Television Masts. And too, Perma-Tube is coated with a metallic vinyl resin—inside and out.

What do the strength and corrosion-resistance of Perma-Tube mean to you? They mean protection for your work and your customers. Freedom from damage due to storms . . . better reception from the sets you install . . . insurance for your reputation . . . increased business and profits for you.

Only **GENUINE** Perma-Tube supports 200 pounds with a minimum of permanent set . . . accept no claims from substitute materials. Look for this Perma-Tube Brand.

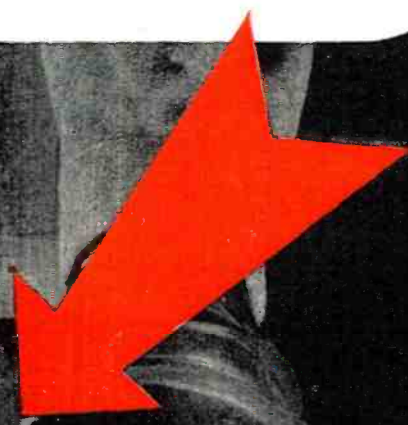

Make this test yourself. Compare Perma-Tube with any other masts—steel or aluminum.



Jones & Laughlin
 STEEL CORPORATION — Pittsburgh

have u.h.f. stations for at least one-half of their affiliates within two years of the new rule; and special permission for ultra-high stations only, initially, to multiplex their sound to provide stereophonic sound transmission.

The lawyer pointed out that the use of stills and sound was very important, because most u.h.f. stations cannot undertake extensive daytime programming and therefore dealers and technicians cannot convert, test, or demonstrate receivers, unless the signals are available. Multiplexing would, it was said, provide an additional advantage to the service that would be attractive to sponsors; it might be applied to low-band transmission, too, once the u.h.f. service was firmly established.

"THE RUMORS OF U.H.F.'s death are greatly exaggerated." So declared FCC's chief economist Hyman Goldin during a meeting of educators in Columbus. He said that no one was denying that there were a long list of woes for u.h.f., but those high-channels will eventually be used, because . . . "this country is too big and too diverse in its interests to be satisfied with only v.h.f. stations." The fact is, he added, that . . . "many substantial communities must look to u.h.f. for their only local station and many others need u.h.f. to obtain an adequate number of program choices."

Reviewing the brighter side of the high-channel picture, the economist pointed out that we must remember that there are now 125 u.h.f. stations on the air, and most of the drop-outs have only been paper grants. He felt that the establishment of a higher power minimum and the extension of the multiple-ownership rule to permit five-station owners to acquire two more u.h.f. stations would help solve the current problem.

AEROELECTRONICS continues to receive accolades on the military and civilian fronts. In Bedford, Massachusetts, the Air Force played host, a short while ago, at a brilliant ceremony dedicating a \$5-million research center.

The wing, part of a new center, which will eventually replace the famed quarters at Cambridge, will house the Command's electronic-research directorate. Over a hundred national, state, and local dignitaries were at the ceremonies. Washington was represented by Air Force Secretary Harold E. Talbott. Main speaker for the event was Lt. General Thomas S. Power, Commander of the USAF Air Research and Development Command in Baltimore.

A formation flight by a group of jet aircraft and B-29 bombers high-lighted the ribbon-cutting affair.

IN WASHINGTON, the subject of aeroelectronics served as the basis of an interesting report by the Radio Technical Commission for Aeronautics
 (Continued on page 18)



The Best Costs Less When You Buy

THE FISHER

Custom Audio Components

■ If you are buying 'for keeps' buy the best *first!* Buy FISHER, *quality leader* for seventeen years. Engineered for the professional, functionally designed for home use. "Of the very best!"—*High Fidelity*.

FM-AM TUNER, Model 70-RT

Features extreme sensitivity, low distortion and low hum. Armstrong system, *adjustable* FM-AFC and AM selectivity. Preamplifier-equalizer, 2 inputs, 2 cathode follower outputs. Six controls. Self-powered. **\$184.50**

FM-AM TUNER, Model 50-R

Same features as 70-RT above, but designed for use with external preamplifier-equalizer such as 50-C. Hum level better than 100 db below 2 volts output. Fully shielded and shock-mounted. Self-powered. **\$164.50**

MASTER AUDIO CONTROL, Series 50-C

16 choices of record equalization, plus separate bass and treble tone controls, loudness balance control. Five inputs and input level controls, two cathode follower outputs. Chassis only, **\$89.50** • With cabinet, **\$97.50**

25-WATT AMPLIFIER, Model 70-A

50-watts peak! More *clean* watts per dollar. Less than ½% distortion at 25 watts (0.05% at 10 watts.) Response ± 0.1 db, 20-20,000 cycles; 1 db, 10 to 50,000 cycles. Hum and noise virtually non-measurable! **\$99.50**

50-WATT AMPLIFIER, Model 50-A

100-watts peak! World's *finest* all-triode amplifier. Uniform within 1 db, 5 to 100,000 cycles. Hum and noise 96 db below full output. IM distortion below 2% at 50 watts. Highest quality components thruout. **\$159.50**

SPEAKER ENCLOSURE, Series 50

NEW! Regardless of the speaker or enclosure you are now using, the "50" Horn will revolutionize its performance. For use with 12" or 15" speaker systems. 50-HM (Mahogany) **\$129.50** • 50-HB (Blonde) **\$134.50**

PREAMPLIFIER-EQUALIZER, Model 50-PR

Professional phono equalization facilities at low cost! Independent switches for LF turn-over and HF roll-off. Output lead up to 50 feet. Can accommodate any low-level, magnetic pickup. Self-powered. **\$22.95**

HI-LO FILTER SYSTEM, Model 50-F

Does what ordinary *tone* controls cannot do, for it suppresses all types of noise with an *absolute minimum* loss of tonal range. High impedance input; cathode follower output. Use with any equipment. **\$29.95**

Prices slightly higher west of the Rockies

WRITE TODAY FOR COMPLETE SPECIFICATIONS

FISHER RADIO CORPORATION • 39 EAST 47th STREET • NEW YORK, N. Y.

CAN YOU HANDLE

7 DAYS' WORK



G.E. SHOWS YOU HOW — with a field-tested plan that has helped hundreds of other TV-radio service dealers. Only plan of its kind in the industry!

Authorities agree that the normal growth of the TV-radio service industry can bring an increase in your business next year equal to one extra day's work a week. To get your full share of this new business, and at the same time boost your profits, you need to organize *now* for top efficiency.

- How to begin, what to do, and how: these questions are answered for you in G.E.'s new **SUCCESSFUL SERVICE MANAGEMENT**. It's a complete plan for improving and strengthening your methods, with accounting, merchandising, and technical helps that service dealers from coast to coast have tested and found successful. If available commercially, this plan would cost you a substantial sum.
- General Electric, however, has made the investment in money and research—its purpose, to *help you help yourself* by becoming a better businessman. Know where you stand financially! Make every advertising and promotion dollar pay ample returns! Stay ahead of competition in technical knowledge! You can do these things with the aid of **SUCCESSFUL SERVICE MANAGEMENT**. See your G-E tube distributor! *Tube Department, General Electric Co., Schenectady 5, N. Y.*

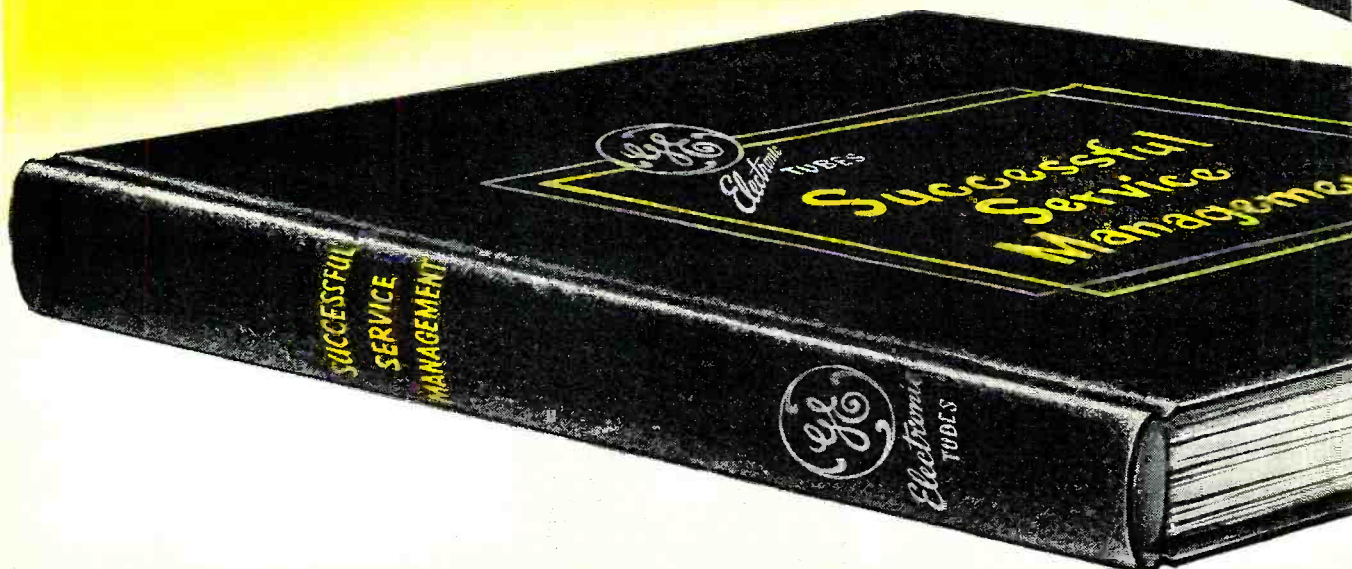

IN 6

NEXT YEAR?

EVERYTHING you need to set up an organized and efficient service business is included in G.E.'s **SUCCESSFUL SERVICE MANAGEMENT**. You learn step-by-step how to manage your—

BUSINESS PRACTICES . . . Are you sure you're making money? . . . Accounting for the TV-radio service dealer (a complete course, with all records and how to keep them) . . . Preparing your income-tax return.

MERCHANDISING . . . Why advertise, why promote? . . . Identification . . . Advertising . . . Direct-mail . . . Window and store display . . . other effective ways to increase your business.

TECHNICAL ACTIVITIES . . . TV trouble-shooting with an oscilloscope . . . Alignment techniques . . . U-h-f servicing . . . other technical instruction, all detailed in its treatment and fully illustrated.

Plenty of operating examples make it easy to understand and apply **SUCCESSFUL SERVICE MANAGEMENT**. Instruction is down-to-earth and practical throughout. For the first time, you have in compact form both an aid to scientific operation of your business, and a guide to its healthy future growth.

Your G-E tube distributor has **SUCCESSFUL SERVICE MANAGEMENT**. See him today!

"We find the business practices material especially good, and use the forms 100% in our bookkeeping."
Silverton TV Service & Sales,
Cincinnati, Ohio

"Plan is very helpful and appreciated. We like the technical section especially well."
Cecil N. Chaney, Humansville, Mo.

"I have been delighted with the information sent us, and cannot at this time think of anything that would improve it."
David S. Hyde, Bloomfield, N. J.

"Information has been excellent and valuable, with the technical data especially useful."
Phil Miller, Kansas City, Mo.

"I have been pleased with the service. It has been very beneficial."
Ralph Moore, Leavenworth, Kan.

"This has been the most helpful material we have yet encountered. It is simply written and easy to understand."
Central Radio & TV Service, Inc.,
Hostings, Mich.

"This material is the finest I have ever seen."
J. C. Wightman, Akron, Ohio

"Your manual has been a wonderful help."
Sterling Electronics, Lincoln Park, Mich.

GENERAL ELECTRIC

161-1A5

Announcing... quick deliveries on

COMCO'S New

FLEETCOM $\frac{6}{12}$ Volt 2-Way Radio



MODEL 400 - 6/12
MOBILE PACKAGE

\$ **460**

F.O.B. Coral Gables, plus
State and Federal taxes.
Price subject to change.

25- 50 MC - 25 WATTS OUTPUT } 8/4 Amps.
152-174 MC - 15 WATTS OUTPUT } Standby (6/12)

- ★ Change from 6 to 12 volts by merely reversing voltage selector plug.
- ★ Rugged construction with heavy duty power relay and fuse for engine compartment mounting.
- ★ Dual frequency provisions built in every unit.
- ★ Readily obtainable 6 volt tubes and vibrator used. 6146 Final amplifier.
- ★ Can be mounted under dash or almost anywhere. Case 11"x12 $\frac{1}{2}$ "x5 $\frac{1}{2}$ ".
- ★ Low cost maintenance with COMCO color code tuning.
- ★ Standard manufacturers parts extensively used and identified for easy replacement at your local supplier.
- ★ Plus many other outstanding features described in bulletin 454 available upon request.

NOTE: Over 150 different COMCO VHF-FM models now certified with U.S. Federal Civil Defense Administration.

ATTENTION DEALERS!
Liberal discounts. Write for available territories.

MANUFACTURERS OF RADIO  & ELECTRONIC EQUIPMENT

COMMUNICATIONS COMPANY, Inc.

CORAL GABLES, MIAMI 34, FLORIDA

(RTCA) on the operational objectives for long-distance navigation aids.

RTCA is a non-profit cooperative association comprising both industrial and governmental agencies. It consists of four major elements; the assembly, executive committee, special committees and the secretariat. The assembly governs the RTCA. It meets twice a year and directs the activities of the group by establishing broad policies and operating procedures. The executive committee manages the affairs of RTCA, and meets monthly. The assembly is composed of approximately 100 U.S. aeronautical telecommunication organizations. Membership in the assembly is wholly voluntary and is open to any organization in the country actively identified with any phase of the air art. The executive committee comprises a representative from the Departments of State, Treasury, Army, Navy, Air Force, and Commerce, FCC, CAB, Aeronautical Radio Inc., Air Transport Association of America, Aircraft Industries Association of America, Inc., RETMA, Air Line Pilots Association, National Business Aircraft Association, and Aircraft Owners and Pilots Association. The Air Transport Association is the organization of the scheduled airlines. Aeronautical Radio is primarily concerned with the radio communication services of the airlines. Technical advisers to RTCA include Congressman Carl Hinshaw, Admiral S. C. Hooper USN (Ret.), Admiral Charles F. Horne, USN (Ret.), FCC Commissioner Edward Webster, Howard Morgan, and Delos Rentzel.

Discussing the uses of the navigation aid system, the report said that a ground-based radio aid to long-distance navigation performs services which are useful in flight control, air-traffic control, search and rescue, and marine navigation.

In ocean navigation, the report disclosed, a system of electronic navigation aids provides a useful function. Primary reliance is placed on celestial navigation procedures. These are supplemented by dead reckoning. In certain parts of the world, adverse weather conditions may prevent use of celestial navigation for extended periods of time, thereby requiring reliance on dead reckoning. In either condition, a radio navigation system provides fixing information which furnishes a useful check upon the accuracy of other navigation procedures.

ELSEWHERE ON THE AVIATION front, the communications division of the International Civil Aviation Organization, issued an important bulletin summarizing its radio-aid meeting in Montreal recently.

At this session the group disclosed that there appeared to be no practicable solution, at present, to the problem of providing air-to-air collision warning by means of airborne radar. But radar could be used, it was said, for storm-cloud detection, terrain mapping, and high-ground indication. It was felt that presently efforts

Free! HEAVY-DUTY TOP-QUALITY PLIERS KIT

with 10 CBS-Hytron Pliers Kit Stamps

LIMITED OFFER

From July 1 through August 31 . . . Your CBS-Hytron distributor will give you 1 Pliers Kit Stamp with your purchase of 25 CBS-Hytron receiving tubes.

A
\$10⁰⁰
LIST VALUE



PICK UP THESE FINE IMPORTED TOOLS. Examine the beautiful finish of their drop-forged tool steel. Try their comfortable handle grips. Feel the precise balance . . . the powerful leverage. Go ahead! Cut some eight-penny nails. Like cutting cheese wasn't it? And not a trace of a nick in the tough, carefully matched jaws.

You will be proud to own these husky, quality pliers. Tested . . . guaranteed . . . they can take it. And did you notice that two are unique? Nothing else just like them . . . they are 'musts' for your tool kit. Yes sir, this free Pliers Kit (packed in an attractive, handy plastic case) is an offer you cannot afford to miss!



The **6-1/2-Inch Diegrabs** are husky, box-joint, fully polished side cutters with precisely matched jaws. Size is right: Compact, but big enough . . . with comfortable, full-fashioned, full-polished handles . . . to do repeated, tough cutting jobs with ease.



The **8-Inch Long-Nose** is unique. Extra-long (2 3/4 inches), spring-tempered jaws combine with extra-long, knurled handles for powerful leverage. Hand-honed cutting knives. Beautifully chrome-plated.



The **6-Inch All-Purpose** is also unique. Combines: Flat and round nose. Jaws shaped for positive gripping. Two wire strippers. Two side cutters. Finish of handles is gun-metal; jaws are fully polished. This tool has everything.

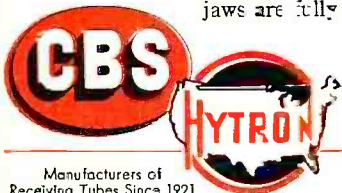

CBS-HYTRON Main Office: Denver, Mass.

Manufacturers of
Receiving Tubes Since 1921

A Division of Columbia Broadcasting System, Inc.

A member of the CBS family: CBS Radio • CBS Television • Columbia Records, Inc. • CBS Laboratories • CBS-Columbia • CBS International • and CBS-Hytron



Get This Pliers Kit Stamp Book . . .

and stamps from your CBS-Hytron distributor: One Pliers Kit Stamp for 25 CBS-Hytron receiving tubes. Each Stamp is imprinted with your CBS-Hytron distributor's code number. Redeem your Stamps with him. This offer is valid only in areas where such offers are legal . . . and it is limited: July 1 through August 31. Don't miss it. Be sure to get your free CBS-Hytron Pliers Kit. See it at your CBS-Hytron distributor's . . . today!

RECEIVING • TRANSMITTING • SPECIAL-PURPOSE • TV PICTURE TUBES • CRYSTAL DIODES AND TRANSISTORS

July, 1954

19

NEW!

Unique!

The only FM Tuner with Photo-Etched Circuit.

THE craftsmen

C900 FM TUNER

**Finest FM Tuner regardless of cost.
Highest in Sensitivity . . .
Lowest in Distortion.**

Another craftsmen first . . . Photo-etched 20.6 mc. transitionally-coupled IF coils insure life-long uniformity and stability of performance under all conditions.

In every performance test by high fidelity experts the C900 has established its outstanding superiority.

FEATURING

Extreme Sensitivity: 1.0 μ v for 20db quieting provided by advanced circuitry of *cascode* rf amplifier. Minimum Distortion: 0.1% IM throughout entire receiver. *Amplified AFC* with front-panel control, assures accurate tuning for minimum distortion. *Entirely new 20.6 mc.* IF system rejects spurious images, reduces oscillator radiation.

See your Hi-Fi Dealer or write to

The Radio Craftsmen, Incorporated, Dept. R7
4403 North Ravenswood Avenue, Chicago 40, Illinois



\$11950 NET

ACTUAL PHOTO OF 20.6 MC. DISCRIMINATOR CIRCUITS, PHOTO-ETCHED IN MULTIPLE ON COPPER-PLATED FORMICA

should be concentrated on the development of a satisfactory storm-cloud detection radar.

Covering the use of secondary radar frequencies, the committee said that it agreed that 1030 megacycles should be used for interrogation and 1090 for reply.

To improve air-ground communications, several new methods were recommended. In areas subject to disturbances in the ionosphere, ground-wave propagation could provide a valuable supplement to the established networks for over-water communications. Congestion on radiotelephony channels could be relieved by taking certain routine traffic off these channels and providing for it by alternative means; for example, the use of ground-to-air teletype equipment offered considerable promise as a vehicle for meteorological broadcasts and other routine information. It was also pointed out that under suitable conditions, the application of selective calling principles—by which an aircraft radio operator listens only to messages directed to his own aircraft and not to any other broadcast on the same channel—would make it simpler for the air crew and result in an improved efficiency of air-to-ground communications.

The division also revealed it felt, in the not-too-distant future, that it may be necessary to develop a means of transferring information from ground to air and from air to ground at a much greater speed than can be done by the use of wireless telephony or telegraphy.

SUBSCRIPTION TV has once again become a see-saw affair in Congress, with some asking for immediate consideration of the matter and others declaring that the subject is not too important, now.

Representative Carl Hinshaw, who offered a bill which would make subscription TV a common carrier, said that the House Interstate Foreign Commerce Committee certainly ought to begin considering this pay method, because it is . . . "being agitated."

Referring to a talk on pay-TV by Dr. Millard C. Fought in New York and Washington, the Congressman said that some very interesting facts on the systems, as they exist now, were disclosed.

According to Dr. Fought, who is a management consultant, in the new techniques, it is possible to make . . . "an unholy mess" of the scrambled signal. Not only is the signal coded, he said, but its code is coded, and the whole business is what one might call randomized. There are available about 5000 different electronic symbols for any given letter of the alphabet, and altogether the system offers 20,000 codes. "Since each customer literally has his own code," the specialist added, "the odds against two neighbors swapping useful information could be one chance in 10, followed by forty zeros."

(Continued on page 100)

Your
FREE copy
is ready!



New Centrallab Catalog No. 29

Keeps you up to date on Centralab's latest developments for faster, more profitable servicing

- New** values in Adashaft* Radiohms
- New** Adashaft shafts
- New** Snap-Tite Controls
- New** Fastatch* Dual Concentric Controls
- New** Senior Compentrol*
- New** miniature rotary phenolic switches
- New** Phenolic Switch Kit
- New** complete line of standard DD disc capacitors
- New** miniature disc capacitors
- New** 3000-VDCW and 6000-VDCW Hi-Vo-Disc* Capacitors
- New** arrangement of capacitor kits
- New** Precision Attachable Terminal Hi-Vo-Kaps®
- New** Negative 330 and Negative 1500 TC Tubular Capacitors
- New** easier-to-read listings on CRL Printed Electronic Circuits
- New** P. E. C.* Kits

*Trademark

Revised, 48-page edition of handy reference book on America's most complete line of volume controls, switches, capacitors, Printed Electronic Circuits*, steatite insulators

Centralab Catalog No. 29 pictures and describes hundreds of CRL components, with exact specifications and details.

Ask your Centralab distributor for your free copy. Or send the coupon to us today.

Centralab

Tear out coupon and mail today!

CENTRALAB, A Division of Globe-Union Inc.
9106 E. Keefe Avenue, Milwaukee 1, Wisconsin

Send me free copy of Centralab Catalog No. 29.

Name.....

Company.....

Address.....

City..... Zone..... State.....

G-3254

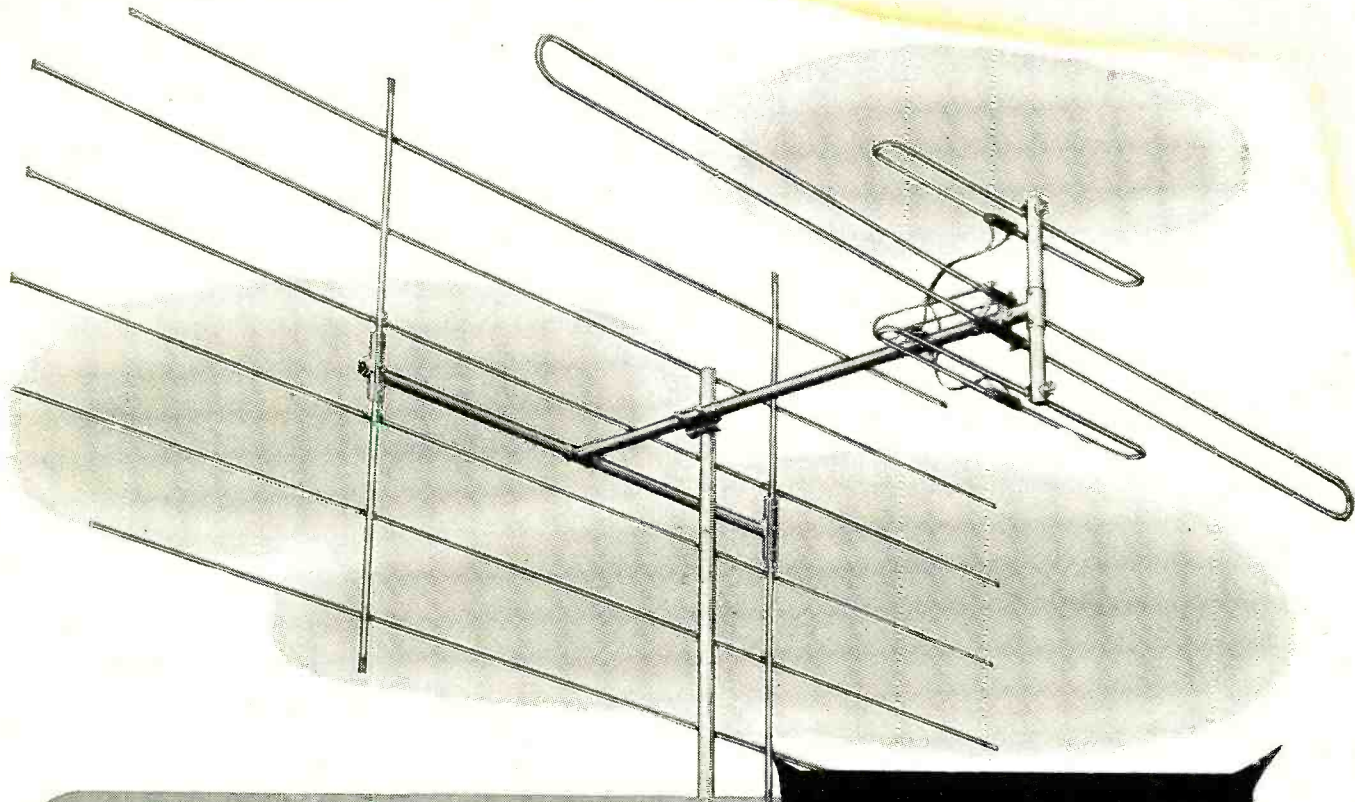

**RADIART
ULTAMATIC
All-Channel TV Antenna**

for the
FIRST time
...the **FIRST**
Antenna with
which You Can
*See the
Difference*

THESE QUALITIES HAVE BEEN COMBINED INTO THIS SINGLE ANTENNA — THE ULTAMATIC...

- ★ **LOW VOLTAGE STANDING WAVE RATIO** ... the mis-match between antenna and transmission line is lower than four competitive types tested, an attribute to its broad band quality.
- ★ **FRONT-TO-BACK RATIO** ... higher than multi-element, yagi-type antennas, minimizing co-channel interference.
- ★ **GAIN** ... expressed in decibels, is a ratio of signal voltage developed by an antenna over that of reference folded dipoles. It is not a quality sold by the pound or achieved by the addition of meaningless elements. The curves shown accurately describe the gain of the Ultramatic. Loss of sound or picture due to erratic antenna response is eliminated.

MECHANICAL FEATURES

- ★ Aluminum screen reflector of exclusive fold-out design, assembled in seconds with adequate stability for years of trouble-free service. Longer elements insure maximum front-to-back ratio on channels 2-6 and are more closely spaced for increased performance on channels 7-13.
- ★ Dipole and boom assembly are of heavy gauge, seamless tubing. Dipoles fold out and are rigidly supported and reinforced to minimize sag and sway.
- ★ Specifically designed mechanically by stress analysis of each unit and sub-assembly to provide a low vibrational period of all elements — your assurance of trouble-free installations.

MODEL UM-213 ... double stacked UM-213-2

Most Uniform Gain Response The gain response DOES NOT VARY MORE THAN 3 D.B. ON ANY CHANNEL across the band. This quality is exceedingly important in color reception to insure adequate color synchronization without resetting.

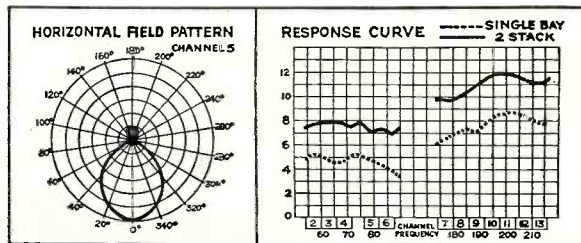

THE RADIART CORPORATION
CLEVELAND 13, OHIO

TV ANTENNAS * AUTO AERIALS * VIBRATORS * ROTORS * POWER SUPPLIES
RADIO & TELEVISION NEWS

They look alike...



...but what a difference!

These RCA types today give you...

LONGER LIFE



SUPERIOR PERFORMANCE



AT NO EXTRA COST

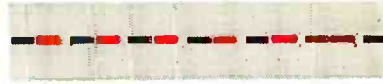

Here are 3 more examples of how regular RCA receiving tubes are constantly being improved to meet the changing requirements of radio and television applications. These RCA types provide you with the superior performance usually claimed for higher priced specialty designed types.

RCA-6J6 features pure tungsten heaters for improved life... uses a special cathode material to help maintain characteristics throughout the life of the tube. Each tube mount is adjusted to provide increased uni-

formity of characteristics of each triode unit.

RCA-6CB6 uses a No. 2 grid of improved design, resulting in lower grid operating temperature and longer tube life. Special controls on materials and processing improve uniformity of plate cutoff and reduce variations in characteristics when heater voltage fluctuates.

RCA-6AU6 uses a double helical heater, resulting in an extremely low hum level. Inverted pinched cathode reduces possible motion of tube ele-

ments thus minimizing microphonics.

The superior performance of *regular* RCA receiving tubes—at *regular* prices—eliminates unnecessary callbacks, assures you of greater customer satisfaction, results in increased profits for you.



When you sell a receiving tube, your reputation and profit depend on its *performance* and *reliability*. So, you can't afford to buy anything less than the best in receiving tubes... and the best are RCA.



RADIO CORPORATION of AMERICA

ELECTRON TUBES

HARRISON, N. J.

The Bell Solar Battery. A square yard of the small silicon wafers turns sunshine into 50 watts of electricity. The battery's 6% efficiency approaches that of gasoline and steam engines and will be increased. Theoretically the battery will never wear out. It is still in the early experimental stage.

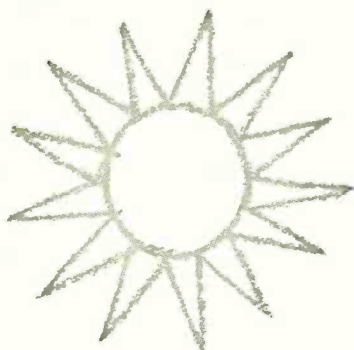
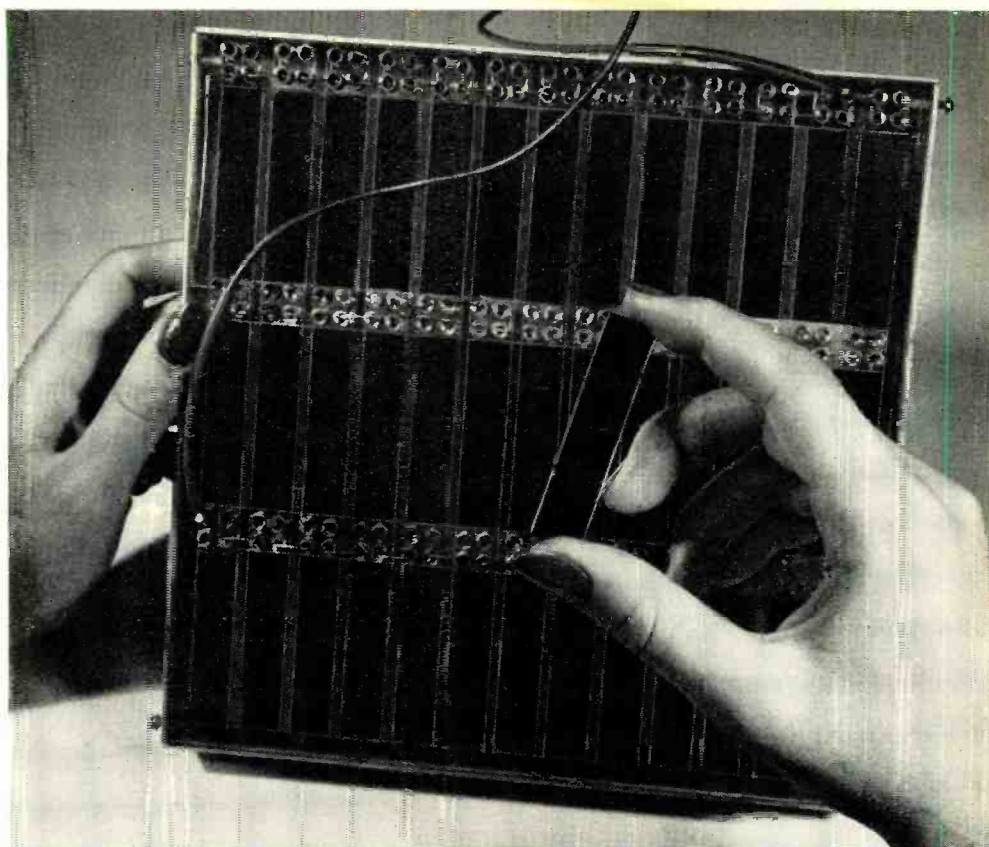

Bell Solar Battery

Bell Laboratories scientists have created the Bell Solar Battery. It marks a big step forward in converting the sun's energy directly and efficiently into usable amounts of electricity. It is made of highly purified silicon, which comes from sand, one of the commonest materials on earth.

The battery grew out of the same long-range research at Bell Laboratories that created the transistor—a pea-sized amplifier originally made of the semiconductor germanium. Research into semiconductors pointed to silicon as a solar energy converter. Transistor-inspired techniques developed a silicon wafer with unique properties.

The silicon wafers can turn sunlight into electricity to operate low-power mobile telephones, and charge storage batteries in remote places for rural telephone service. These are but two of the many applications foreseen for telephony.

Thus, again fundamental research at Bell Telephone Laboratories paves the way for still better low-cost telephone service.



Inventors of the Bell Solar Battery, left to right, G. L. Pearson, D. M. Chapin and C. S. Fuller — checking silicon wafers on which a layer of boron less than 1/10,000 of an inch thick has been deposited. The boron forms a "p-n junction" in the silicon. Action of light on junction excites current flow.



BELL TELEPHONE LABORATORIES

IMPROVING TELEPHONE SERVICE FOR AMERICA PROVIDES CAREERS FOR CREATIVE MEN IN SCIENTIFIC AND TECHNICAL FIELDS



**Train for a secure career
—not just another job!
Success ahead for trained men
only in**



Radio-TV-Electronics

**Stop Dreaming! Start Planning!
Start Doing! Start Your**

CREI CAREER TRAINING AT HOME TO INSURE MORE INCOME!



COLLEGE DEGREE NOT ESSENTIAL—You don't have to be a college graduate to benefit from CREI's famed courses. You *do* have to be willing to study at home. You can do it while holding down a full time job. Thousands have. No matter what your level of electronics experience, CREI has a course for you.

CREI's professional guidance is recognized all over the world. Since 1927 CREI has trained technicians; you find them in radio and television stations; you find them in electronics planning and manufacture; you find them everywhere and, generally, near the top. During World War II CREI trained men for the Armed Services. Leading firms choose CREI courses for group training in electronics (among them are United Air Lines, Canadian Broadcasting Corp., Trans-Canada Airlines, Bendix Products Division, RCA Victor Division and Canadian Marconi).

WHAT YOU DO NOW—today, tomorrow, next week—will decide your success in the electronics field. Every day counts because the trained technicians are the ones who get the "plums" when promotions are handed out. How can you be sure to step ahead of competition, to earn more money, to get the position that carries more responsibility—and the pay that goes with it? The answer is contained in a CREI booklet called "Your Future in the New World of Electronics."

ERA OF COMMUNICATION

This is the era of Communication: aeronautical, marine, police and fire, industrial, land transportation. This is the era of defense orders and a manufacturing industry which last year alone sold billions of dollars worth of electronic equipment, which will top ten billion dollars (without military) this year. This is the era of electronic development, research, design, production, testing, inspection, manufacture, broadcasting, telecasting and servicing. This is the era of electronic careers—well-paid, interesting, and secure.



CREI resident instruction (day or night) is offered in Washington, D.C. New classes start once a month.

VETERANS: If you were discharged after June 27, 1950—check the coupon for full information about the new G. I. Bill of Rights.

PRACTICAL COURSES

CREI's practical courses are prepared by recognized experts. You get up-to-date material. Your work is under the supervision of a regular staff instructor who knows and teaches what industry needs. Training is accomplished on your own time, during hours chosen by you.

KEY TO SUCCESS—As a graduate you'll find your CREI diploma the key to success in the entire field of electronics. At your service is the Placement Bureau which finds positions for advanced students and graduates. No short cuts are promised; no jobs are guaranteed—but requests for CREI-trained personnel far exceed current supply.

This can be your big year! Write today for complete details. Tuition is reasonable, terms are easy, information is free. Fill out the coupon and mail it at once.

WHO WILL GET AHEAD?



There's a vacancy coming up. It means a boost in pay, prestige and responsibility. Can you fill it? The answer is NO if you postpone your self-training. The answer is YES if you're trained in electronics.

CAPITOL RADIO ENGINEERING INSTITUTE

An Accredited Technical Institute
3224 16th St., N.W., Washington 10, D. C.



MAIL COUPON FOR FREE BOOKLET

CAPITOL RADIO ENGINEERING INSTITUTE

Dept. 117-A 3224 16th St., N.W., Washington 10, D. C.

Send booklet "Your Future in the New World of Electronics" and course outline.

- CHECK FIELD OF GREATEST INTEREST
- TV, FM & Advanced AM Servicing
 - Practical Television Engineering
 - Broadcast Radio Engineering (AM, FM, TV)
 - Practical Radio Engineering
 - Aeronautical Radio Engineering

Name

Street

City Zone State

Check Residence School Veteran

WORLD'S LARGEST MANUFACTURER
OF CUSTOM BUILT TELEVISION

MATTISON

SILVER ROCKET 630 CHASSIS

Featuring Syncromatic Tuning

NO DRIFT UHF-VHF-DX

ONLY THE MATTISON 630 ELIMINATES DRIFTING APART OF PICTURE AND SOUND ON UHF, VHF and DX RECEPTION. SELECT YOUR CHANNEL SOUND IS AUTOMATIC. (Syncromatic tuning is an exclusive Mattison 630 Circuit)

Tube Complement:
29 tubes
3 rectifiers
1 CRT

SILVER ROCKET
630 Chassis with
built in UHF Tuner

33

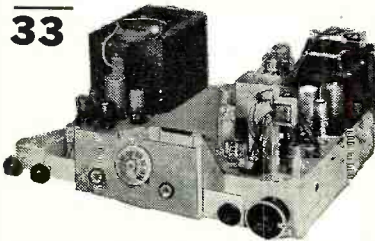

All Channel UHF Tuner

• UHF Cascode I.F. amplifier adds additional I.F. stage. Vary important because UHF transmitters operate with moderate power and RECEIVER must be sensitive to give top notch UHF performance.

SILVER ROCKET 630 CHASSIS

• with TUNEABLE •

BUILT-IN BOOSTER for Better DX Reception

Tube Complement:
28 tubes
3 rectifiers
1 CRT

Select Your
Channel . . .
SOUND IS
AUTOMATIC!

32

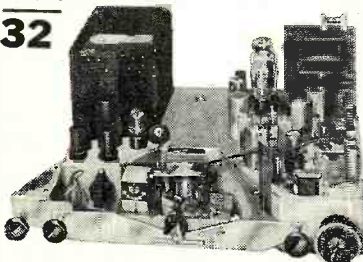

Tuneable Booster

• Broad band single knob control pre-amplifier built in to eliminate long leads which may cause regeneration and attenuation of signal.

• ONLY THE MATTISON 630 CHASSIS HAS AN ALL CHANNEL TUNEABLE BUILT-IN BOOSTER THAT INCREASES SIGNAL STRENGTH UP TO 10 TIMES.

ALL CABINETS MADE IN MATTISON'S OWN CABINET FACTORY. AVAILABLE IN EVERY FINISH AND STYLE. WRITE FOR COMPLETE CATALOG.

DEALERS! SERVICE MEN! Here is your opportunity to become the "important" TV Dealer in your area for THE FINEST CUSTOM-BUILT LINE OF TV RECEIVERS. FREE!! Write for Mattison's merchandising portfolio explaining the "UNASSEMBLED PLAN" and "\$1,000,000 FLOOR PLAN."



Manufactured with integrity

Mattison Television & Radio Corp.
10 West 181st St., Dept. RN, N. Y. 53, N. Y.

When you buy from Mattison you need only one source of supply! You can buy a Mattison Chassis, a Mattison Cabinet or a complete Mattison TV Set!

Within the INDUSTRY

JOHN D. VICKREY has joined the engineering department of *International Rectifier Corporation* as a sales and application engineer for selenium rectifiers.



He was formerly assistant manager for *Lee Electric Mfg. Company* and prior to that was sales and application engineer with the *Vickers Electric Division*.

He received his degree in electrical engineering from USC, is a registered professional engineer, and a member of the AIEE.

WESTERN ELECTRONIC SHOW & CONVENTION (WESCON) has been scheduled for August 25-27 at the Los Angeles Pan-Pacific Auditorium.

Sponsored jointly by the West Coast Electronic Manufacturers' Association and the San Francisco and Los Angeles sections of the IRE, show officials anticipate the greatest exhibitor participation in the history of the show.

An interesting program has been planned for those attending the convention including social events for delegates and women guests.

The Ambassador Hotel in Los Angeles will be convention headquarters.

EDWARD C. BONIA has been appointed manager of dealer relations for *Emerson Radio and Phonograph Corporation*. He will function as the coordinator of factory-dealer relations on a national level.



Mr. Bonia has 25 years' experience in the radio and television field, including a period during which he served as general sales manager of radio and television for *Bendix*. He was most recently president of *E. C. Bonia, Inc.*, a national sales organization marketing TV receivers and appliances.

He was associated with *Sparks-Whittington Company* for 19 years, advancing from the position of distributor salesman to vice-president for radio sales.

NORBERT F. DERR COMPANY, a manufacturers' representative firm, has been established at 937 S. Ashburton Road, Columbus 13, Ohio. It will represent electronics accounts in Ohio and Kentucky . . . **LEVINTHAL ELECTRONIC PRODUCTS, INC.**, a new company, is occupying a newly-constructed building

at 2821 Fair Oaks Ave., Redwood City, California. The firm will manufacture electronic medical instruments and do research, development, and merchandising work on other products relating to the fields of applied physics and electronics . . . **DAGE ELECTRONICS CORPORATION** of Beech Grove, Indiana has announced its affiliation with **THOMPSON PRODUCTS, INC.** of Cleveland. **DAGE** will operate as a decentralized division of the parent firm's electronics division.

FCC has announced the assignment of amateur call sign prefix KC4 to Navassa Island in the Greater Antilles in the Caribbean. In case any U.S. amateur station is ever established on that island, the call sign will be selected from the block KC4AA through KC4AZ.

C. CHANDLER COLE has been named general manager of the *Ward Products Division of The Gabriel Company* of Cleveland.



He was formerly a top executive with several industrial firms in the Chicago area. His background in finance, manufacturing, and sales has brought him into contact with a number of firms in the scope of activity of reorganization and revitalization.

Mr. Cole will divide his time between the company's offices in Cleveland and the antenna plant in Ashtabula, Ohio.

TRAV-LER RADIO CORPORATION is now in production in its new 70,000 square foot addition to its plants in Orleans, Indiana. Designed to handle production of TV, hi-fi products, and color sets, the new addition now gives the firm 210,000 square feet of production space in Orleans . . . **SYLVANIA ELECTRIC (CANADA) LTD.**, has announced plans to construct a new television receiver plant at Dunnville, Ontario. The 68,000 square foot plant is scheduled to begin production August 1st . . . **JENSEN MANUFACTURING COMPANY** of Chicago has acquired a new plant in Guttenberg, Iowa where a standardized line of speakers for volume industrial customers will be manufactured . . . **RADIO CITY PRODUCTS CO., INC.** of New York has moved its engineering department and development laboratories to its factory location at Easton, Pa. The general and administrative offices were moved to Easton some time ago . . . **ELECTRONIC MARKETERS, INC.**, electronic parts distributor, has moved to new and larger quarters at 25-27

The BACKSTOP

STOPS co-channel and adjacent-channel interference caused by rear signal pick-up!

- Highest front-to-back ratio ever built into an antenna!
- No rear pick-up; eliminates "venetian blinds"!
- Largest screen area: 70 square feet!
- Very high all-channel gain. Incorporates basic Champion design, including Tri-Pole, with additional elements!
- Completely preassembled!

Table of Front-to-Back Ratios (Relative Voltage)

Channels	Front-to-Back Ratios
2	9:1
3	10:1
4	11:1
5	20:1
6	18:1

Only Low Band channels shown, since co-channel interference is not encountered on High Band channels.

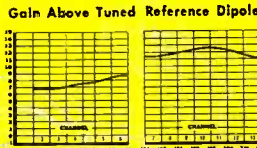
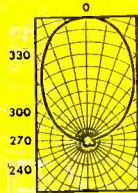

IMPORTANT . . . don't be misled by polar patterns representing relative POWER. Remember, power is the square of voltage. All Channel Master polar patterns are presented in relative VOLTAGE.

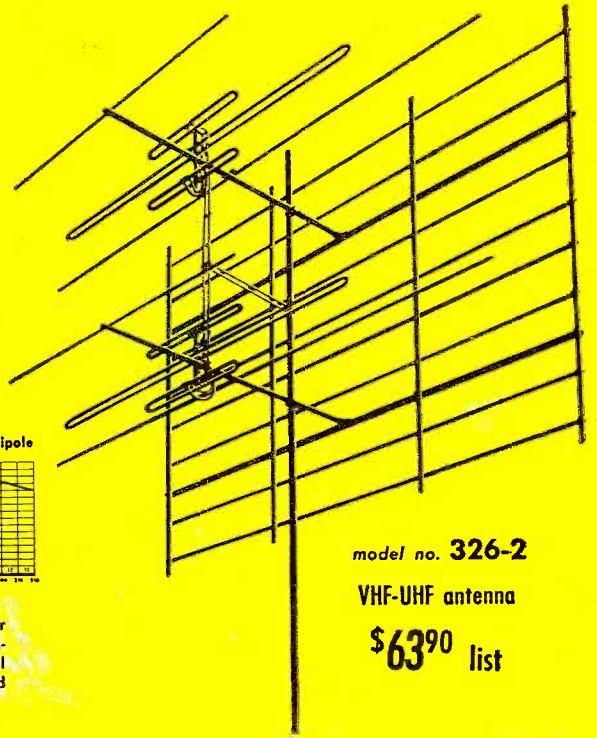

model no. 326-2

VHF-UHF antenna

\$63⁹⁰ list

2 radical new antennas by CHANNEL MASTER

The most beautiful antenna ever made! The only indoor antenna featuring powerful outdoor design principles — Bow-Tie and Screen.

Wonder Bow

* VHF-UHF indoor antenna

DESIGNED FOR POWER!

On UHF: For primary and secondary areas. In many cases, performance is equal to actual outdoor installations. Good directivity on all channels.

On VHF: Ideal in areas of strong VHF signals.

STYLED FOR BEAUTY!

Designed by a well-known industrial designer, the WONDER BOW is proof that indoor antennas can be beautiful as well as powerful. Wins customer approval on beauty alone!

The first gain figures ever to be published for an indoor antenna!

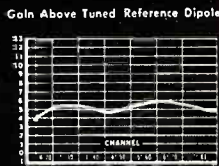

Gold and black

model no. 416

Silver and black

model no. 417

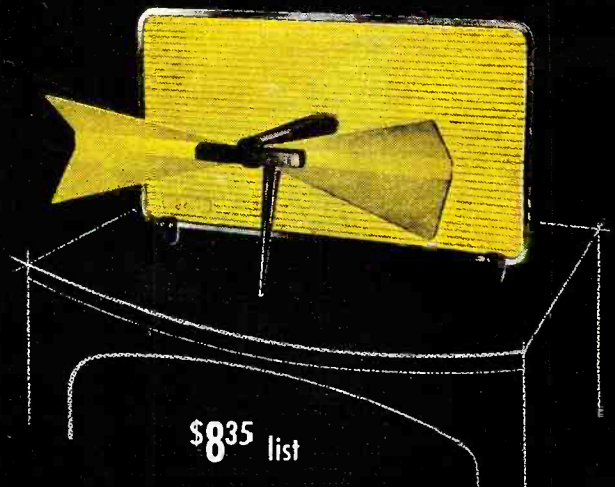

\$835 list



CHANNEL MASTER CORP. LENEXIA, N. Y.

The World's Largest Manufacturer of TV Antennas

Write for complete technical literature.

Copyright 1954, Channel Master Corp.

*Pat. No. D-171560

NEW! BERLANT BROADCAST RECORDER



\$545.00

ANSWERS THE NEED

In a nation-wide questionnaire the chief engineers of radio stations and recording studios were asked to set the specifications for the ideal professional tape recorder.

They did... THIS IS IT!

PERFORMANCE

Every requirement of frequency response, freedom from distortion, stability of motion, dynamic range, timing accuracy and tape handling ability is met and exceeded by this recorder at both tape speeds.

DEPENDABILITY

Designed and built for continuous operation under the most rigorous conditions, this recorder combines rugged components and advanced engineering to guarantee maximum dependability with minimum maintenance.

SIMPLICITY

New concepts in design, construction and operation result in a functional simplicity that is reflected in the recorder's performance, dependability and last, but not least — economy.

TO THE ENGINEER

Compare this machine, point by point, with any other recorder on the market, regardless of price. You will find it the ideal recorder for your needs.

EXCLUSIVE FEATURES

UNISYNC DRIVE

This radical improvement in design brings a new standard of quality to sound recording. An integral unit, consisting of an "inside out" hysteresis synchronous motor, fly-wheel and blower provides a cooler, lighter, smoother drive than has been previously possible.

FIVE HEADS

Instead of the usual three heads, the BR-1 can accommodate up to five. This permits playback of a delayed broadcast while recording an incoming program on the same tape. Single and dual track operation of one recorder is also possible.

UNIFIED CONTROL

All operations of the recorder are combined in a single, convenient error-proof lever system. Tape handling in fast forward and rewind can be at any speed from zero to full spooling. This permits rapid location of any desired section of tape.

A-B TEST FADER

An exclusive method of fading from the incoming signal to playback from the tape eliminates all clicks and noises previously inherent in such A-B tests.

Bert Berlant

WRITE FOR BROCHURE NUMBER 2Y

**BERLANT CONCERTONE
BERLANT ASSOCIATES
4917 WEST JEFFERSON BLVD.
LOS ANGELES 16, CALIFORNIA
MANUFACTURERS OF CONCERTONE
WORLD'S FOREMOST HIGH FIDELITY
TAPE RECORDERS AND ACCESSORIES**

Hoyt St., Newark 3, N.J. . . . **RAY-THEON MANUFACTURING COMPANY** has opened its ultra-modern electronics laboratory at Bedford, Mass. The \$2,000,000 plant has 100,000 square feet of floor space on two floors and will house approximately 700 workers.

NORMAN C. OWEN has been named president of *Webster-Chicago Corp.* following the annual meeting of the company. He was formerly vice-president in charge of sales.

E. J. Moritz, general manager of the laminations division was elected vice-president in charge of manufacturing. Other officers who were re-elected include R. F. Blash, chairman of the board; Walter P. Altenburg, vice-president and general counsel; G. W. Wallin, vice-president in charge of engineering; C. B. Dale, vice-president in charge of research; Herman Biechele, secretary; and Edward R. Johnson, treasurer.



BRUCE A. COFFIN, formerly vice-president and a director of *Columbia Broadcasting System*, has been elected to the post of chairman of the board of directors of *Victoreen Instrument Company* of Cleveland.

The board also re-elected Cyrus W. Haller president of the firm and renamed Harold S. Carter vice-president and Raymond F. Shima the secretary-treasurer.

The firm manufactures radiation detection instruments, color television, and electronic components.



JOHN BENTIA has been promoted to the post of executive vice-president of *Alliance Manufacturing Company* by the firm's board of directors . . . **RALPH H. G. MATHEWS**, veteran radio and electronics engineer, has joined *The Magnavox Company* as general sales counsel for the high-fidelity division. He will make his headquarters in Fort Wayne, Ind. . . . *Kierulff Sound Corporation* has named **FRANK GONZALEZ, JR.**, to the post of sales manager. He has been with the firm since 1948 . . .

JAY T. NICHOLS is the new chief engineer of *Pentron Corp.* His job will include the development of magnetic recorders for both commercial applications and government services . . . **NELSON B. SHERRILL** has been appointed sales manager of the electrical division of *Olin Industries, Inc.* He will maintain offices at the division's headquarters in New Haven, Conn. . . . *Chester Cable Corp.* has appointed **JOHN LACHMANN** to the post of executive technical director. He was formerly with *E. I. du Pont de Nemours* . . . **J. LEONARD COHEN**, formerly with *DeWald Radio Mfg. Co.*, has

(Continued on page 116)

RADIO & TELEVISION NEWS

Home Study Courses in TELEVISION SERVICING offered by RCA INSTITUTES



Study Television Servicing—from the very source of the latest, up-to-the-minute TV and Color TV developments. Train under the direction of men who are experts in this field. Take advantage of this opportunity to place yourself on the road to success in television. RCA Institutes, Inc. (A Service of Radio Corporation of America), thoroughly trains you in the "why" as well as the "how" of servicing television receivers.

FIRST HOME STUDY COURSE IN COLOR TV SERVICING

Now you can train yourself to take advantage of the big future in Color TV. RCA Institutes Home Study Course covers all phases of Color TV Servicing. It is a practical down-to-earth course in basic color theory as well as how-to-do-it servicing techniques.

This color television course was planned and developed through the combined efforts of instructors of RCA Institutes, engineers of RCA Laboratories, and training specialists of RCA Service Company. You get the benefit of years of RCA research and development in color television.

Because of its highly specialized nature, this course is offered only to those already experienced in radio-television servicing. Color TV Servicing will open the door to the big opportunity you've always hoped for. Find out how easy it is to cash in on color TV. *Mail coupon today.*

SEND FOR FREE BOOKLET

Mail coupon in envelope or paste on postal card. Check course you are interested in. We will send you a booklet that gives you complete information. *No salesman will call.*



RCA INSTITUTES, INC.
A SERVICE OF RADIO CORPORATION of AMERICA
350 WEST FOURTH STREET, NEW YORK 14, N.Y.

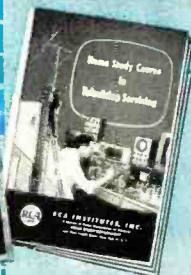

HOME STUDY COURSE IN BLACK-AND-WHITE TV SERVICING

Thousands of men in the radio-electronics industry have successfully trained themselves as qualified specialists for a good job or a business of their own—servicing television receivers. You can do this too.

This RCA Institutes TV Servicing course gives you up-to-the-minute training and information on the very latest developments in black-and-white television.

As you study at home, in your spare time, you progress rapidly. Hundreds of pictures and diagrams, easy-to-understand lessons help you to quickly become a qualified TV serviceman.

There are ample opportunities in TV, for radio servicemen who have expert training. Mail coupon today. Start on the road to success in TV Servicing.

MAIL COUPON NOW

RCA INSTITUTES, INC.
Home Study Dept. RN-754
350 West Fourth Street, New York 14, N. Y.

Without obligation on my part, please send me copy of booklet on:

- Home Study Course in TELEVISION SERVICING.
 Home Study Course in COLOR TV SERVICING.

Name _____ (please print)

Address _____

City _____ Zone _____ State _____

NOW... 2 SENSATIONAL EICO SCOPE VALUES!

NEW AMAZING FEATURE PACKED
7" PUSH-PULL OSCILLOSCOPE

Only EICO Has All These Features

VERTICAL FREQ. RESPONSE:
flat ± 2 db 10 cps - 1 mc
VERTICAL SENS.: .01 volts rms/inch
HOR. FREQ. RESP.: flat ± 0 db 10 cps - 200 kc - 4 db at 500 kc
HOR. SENS.: .3 volts rms/inch
SWEEP RANGE: 15 cps-100 kc
3-STEP FREQ.-COMPENSATED ATTENUATOR eliminates freq. distortion, overloading.
CATHODE FOLLOWER inputs to both amplifiers
PUSH-PULL outputs in both amplifiers
RETURN TRACE BLANKING
INT. VOLTAGE CALIBRATOR
V & H TRACE EXPANSION & CENTERING: 2.5X full screen without distortion.
DIRECT CONNECTION to vert. CRT plates.
PHASING CONTROL of internal 60 cps sine wave sweep.
AT FRONT PANEL: intensity mod. input; 60 cps, sawtooth outputs.

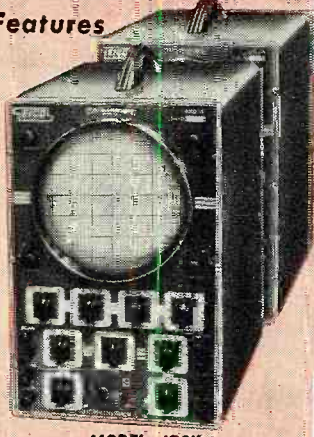

MODEL 470K
KIT \$79.95. WIRED \$129.50.

HIGH VOLTAGE PROBE \$6.95
● Extends range of VTVMs & voltmeters to 30 KV.



CATHODE RAY TUBE CHECKER 630K, WIRED \$24.95 KIT \$17.95



● Checks all types of TV picture and C.R. tubes in the set or carton. Bridge measurement of peak beam current (proportional to screen brightness).
● Detects shorted & open elements.

625K TUBE TESTER KIT \$34.95. WIRED \$49.95.



● Illum. gear-driven "Speed Rollchart."
● New lever-action switches for individual testing of every element.
● Tests all conventional & TV tubes.
PIX TUBE ADAPTER for Tube Testers \$4.50. Checks TV picture tubes while in set.

360K SWEEP GEN. KIT \$34.95. WIRED \$49.95.

● Continuous coverage of all TV & FM freqs. from 500 kc to 228 mc.
● Sweep width variable 0-3C mc.
● Crystal marker oscillator, variable amplitude.

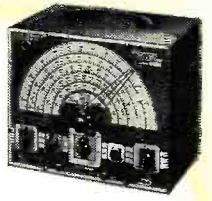

214K VTVM KIT \$34.95. WIRED \$54.95.
249-K F-P KIT \$39.95. WIRED \$59.95.



● Large 7 1/2" meter, can't-burn-out circuit.
● AC/DC volts: 0-5, 10, 100, 500, 1000 (30 KV with HV Probe).
● 5 ohms ranges from .2 ohm to 1000 meg.
● DC input Z 26 meg.
● 1% mult. resistors.

Large 7 1/2" meter

950A-K R-C BRIDGE & R-C-L COMP. KIT \$19.95. WIRED \$29.95.



● Measures & tests all resistors; .5 ohm to 500 megohms.
● Every type condenser, 10 mmf to 5000 mfd.
● 0-500 DC voltage source for capacitor leakage testing.

EXCLUSIVE! 5" PUSH-PULL SCOPE, 425K, Amazing feature-packed economy-priced
Wired \$79.95. KIT, \$44.95.

SH-PULL V & H amplifiers. Sens: 0.5-1 rms v/in. Useful to 2.5 mc.
EEP. 15 cps-76 kc. Z-axis intensity modulation. Dual trace positioning controls.

SCOPE VOLTAGE CALIBRATOR KIT 495K KIT \$12.95. WIRED \$17.95.
● Sq. wave output at power-line freq. with full-scale readings of 1, 10 or 100 V. peak-to-peak
● Accuracy $\pm 5\%$ of full-scale on each range.

12V BATTERY ELIMINATOR KIT 50K KIT \$29.95. WIRED \$38.95.
● DC output: 0-8 V or 0-16 V.
● Continuous current rating: 1 A at 6 V, 6 A at 12 V.
● Intermittent current rating: 12 A at 6 V, 12 A at 12 V.
● Separate Voltmeter & Ammeter.

NOW! ONLY EICO KITS & WIRED INSTRUMENTS Gives You LIFETIME SERVICE & CALIBRATION GUARANTEE*
*at less than our cost of handling (See EICO Guarantee Card enclosed with each Kit & Instrument).

BAR GENERATOR 352K, WIRED \$19.95 KIT, \$14.95

● Enables rapid adjustment of TV picture V & H linearity without hard-to-find station transmitted test pattern.
● Produces 16 V or 12 H bars. Operates on TV channels 3, 4, or 5.

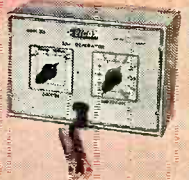

Prices 5% higher on West Coast. Specifications and prices subject to change without notice.

New! EICO SCOOPS!

322K PEAK-to-PEAK VTVM with DUAL-PURPOSE AC/DC Uni-Probe*
KIT \$29.95 WIRED \$49.95



Measures directly p-p voltage of complex and sine waves: 0-4, 14, 42, 420, 1400, 4200 V p-p. DC/RMS sine voltage range: 0-1.5, 5, 15, 50, 150, 500, 1500 v. Ohms: 0-1000 meg. 7 non-skip ranges on every function. Calibration without removing from cabinet. Zero center. Freq. Resp. 30 cps-3mc. 1% precision ceramic multipliers. Exceptional stability and accuracy. Compact, portable (8 1/2 x 5 1/2"), smart, rugged.

NEW! UNI-PROBE! Terrific time-saver! Only 1 probe for all functions—a half-turn of probe-tip selects DC or AC-OHMS!

449 K PEAK-to-PEAK VTVM with 7 1/2" METER KIT \$39.95 WIRED \$59.95

944 K FLYBACK TRANSFORMER AND YOKE TESTER Kit \$23.95 Wired \$34.95

Tests all flybacks and yokes, in or out of TV set—in just seconds! Detects even 1 shorted turn! Exclusive separate calibration for air- and iron-core flybacks assures utmost accuracy. Large 4 1/2" meter, 3 colored scales. Compact, portable (8 1/2 x 5 x 5"), smart, rugged.

1171K RES. DECADE BOX KIT \$19.95 WIRED \$24.95
DECADE CONDENSER BOX KIT 1180K KIT \$14.95 WIRED \$19.95
WMA RESISTANCE SUBSTITUTION BOX 1100K WIRED \$9.95 KIT \$5.50



305K DELUXE SIG. GEN. KIT \$39.95. WIRED \$59.95.

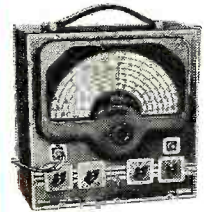

● Covers range of 75 kc to 150 mc.
● 7 calibrated scales: accuracy better than 1%.
● Bandsread vernier tuning.
● 4-step RF shielded output multiplier: constant output Z.

377K SINE & SQUARE WAVE AUDIO GEN. KIT \$31.95. WIRED \$49.95.



● Complete sine wave coverage, 20-200,000 cps in 4 direct-reading ranges.
● Complete square wave coverage, 60-50,000 cps.
● Cathode follower output circuit.

565K MULTIMETER KIT \$24.95 WIRED \$29.95.



555K MULTIMETER KIT \$29.95 WIRED \$34.95. (1% precision resistors)
● 20,000 Ω/V ; 31 ranges.
● DC/AC/Output volts: 0-2.5, 10, 50, 250, 1000, 5000.
● DC Current: 0-100 μ a; 10, 100, 500 ma; 10 A.
● Ohms: 0-2K, 200K, 20 meg.

145K SIG. TRACER KIT \$19.95. WIRED \$28.95.



● Audibly signal traces all IF, RF, Video & Audio circuits from ANT to SPKR or CRT in all TV, FM, AM, etc. without switching.
● Germanium crystal diode probe responsive to over 200 mc.
● Integral test speaker.

536K MULTIMETER KIT \$12.90. WIRED \$14.90.
526K MULTIMETER KIT \$13.90. WIRED \$16.90.



● 1000 Ω/V ; 31 ranges
● DC/AC volts: Zero to 1, 5, 10, 50, 100, 500, 5000.
● DC/AC Current: 0-1, 10 ma; 0.1, 1 A.
● Ohms: 0-500, 100 K, 1 meg.

320K SIG. GEN. KIT \$19.95. WIRED \$29.95.
322K SIG. GEN. KIT \$23.95. WIRED \$34.95.



● Fundamentals 150 kc to 34 mc, harmonics to 102 mc.
● 5-step band switching.
● Colpitts audio oscillator generates 400 cps pure sine wave voltage.
● Permits pure RF, modulated RF, or pure AF.

Write NOW for FREE latest Catalog R-7
Ask your jobber for FREE EICO business building decals.



Separate Assembly & Operating Manuals supplied with each EICO KIT!
You build EICO Kits in one evening, but... they last a lifetime!
SAVE OVER 50%! See the famous EICO line TODAY, at your local jobber.

FROM

CATSWHISKERS TO COLOR

AN EDITORIAL by OLIVER READ

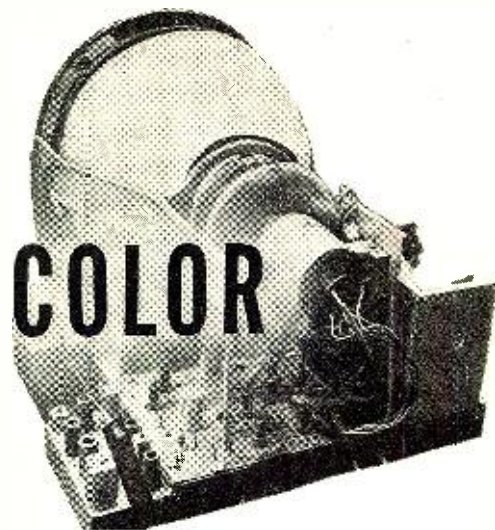

RADIO & TELEVISION NEWS (titled "Radio Amateur News," July 1919) was in existence long before the first broadcast station went on the air, as it was not until November 2, 1920, that KDKA, the world's first broadcast station, was put into operation. Dr. Frank Conrad, 8XK, radio amateur, and prominent engineer of *Westinghouse* had been consistently experimenting with voice transmission, occasionally sending out programs of phonograph music and talks over his ham station. A newspaper carried the advertisement of a Pittsburgh store offering radio receivers which would enable one to tune in the broadcasts of 8XK. The rest is history. *Westinghouse* officials decided that radio should be developed as a publicity medium rather than a straight communications service and early in 1920 plans for the operation of KDKA were made.

Mirroring the development of radio for the past 35 years, RADIO & TELEVISION NEWS has recorded the progress of radio virtually from the "stone age" of reception when the crystal receiver was titillating the imagination of the amateur up to the high standards of communications now in existence. R&TN not only has acted as a historian of radio progress, but the various departments of amateur radio, television, and broadcasting have been crystallized, based on the pioneering of many articles which have appeared in early issues. Such developments as television, synchronization of two or more stations on the same wavelengths, and the first radio musical instruments were all pioneer developments of our writers.

During the initial year of R&TN's publication, crystal sets costing from \$15.00 to \$25.00 were in vogue. One-tube sets were too expensive for the average purse, considering how slightly better they were than crystal sets. Soon the regenerative receiver made its appearance. Dr. de Forest, for example put out the MR-6 which sold for approximately \$150.00 without accessories. It consisted of a honeycomb coil tuner and two stages of audio-frequency amplification. Shortly there-

after, *Radiola* came out with a model that resembled a small table radio phonograph having a lid and concealed horn. It operated from dry batteries and used four WD-11 tubes. It was considered a luxury to have accessories in those days. Some horns, to which a headset could be attached, sold for around \$15.00. Even grid leaks and rheostats cost as much as \$2.50 each, while other components were similarly high priced. When the famous 201A tube came out, dealers were getting premium prices for them as there were no "ceilings" in those days. Many hams paid ten dollars apiece for these cherished "bottles."

The entire progress of broadcasting is due largely to the efforts of the amateur, even though he seldom got a break from the authorities who regulated activities in those early days. All broadcast stations were operating on 360 meters while the hams were found from 200 meters and below. They were then putting on amateur talent shows from their own stations and most of the entertainment was by means of phonograph records and musical instruments.

The Department of Commerce then relegated them to the short waves and banned entertainment directed to the public. Their transmissions were confined thereafter to code and voice. They bowed gracefully to the decree and pushed on to explore the new realms which were opened to them despite the premonition that as soon as these were developed they, too, would be taken from them.

Throughout the years, RADIO & TELEVISION NEWS has recorded the ever growing development of the radio amateur since the early trail-blazing days of such prominent hams as the late Major Edwin H. Armstrong of regenerative, superregenerative, and superheterodyne fame; John Grinan; Dick Richardson, the Princeton boy who had one of the few operator's licenses during World War I; J. O. Smith, the first amateur to install c.w. in place of spark; Ralph Waldo Emerson Decker; Frank Conrad; Lloyd Hammarlund; and a host of others.

The first issue of this magazine (15,000 copies) included a release to the effect that amateur stations were permitted to re-open on April 15, 1919 following World War I. Approximately sixteen times as many copies of RADIO & TELEVISION NEWS are now printed monthly. In this same year, a young man by the name of A. H. Grebe was working on an amateur apparatus after analyzing the outstanding features of the new types of equipment that were being used by the radio amateurs in government service and who were returning to their peacetime vocations following the signing of the Armistice. Dr. Lee de Forest, in his article "The Audion and The Radio Amateur" told of the advantages of using the vacuum tube and the superior performance that it was capable of providing over existing detector methods.

On October 1, 1919, all restrictions on amateur radio stations were removed. A warning was issued by G. K. Thompson, *American Radio and Research Corp.*, to amateurs that unless they cultivated at once a conscientious respect for Federal radio regulations, the liberties of amateur radio would be doomed. Considerable work was being done with underground antenna systems, but this method was soon discarded in favor of flat-top and cage systems. Maj. Gen. George O. Squier, then Chief Signal Officer, United States Army, in his article "Tree Radio Telephony and Telegraphy," August, 1919, RADIO NEWS, described further experiments, which he had started as early as 1904, in the use of growing trees for antenna systems for radio telegraphy. Amateurs were using loop antennas commonly in their shacks. In fact, many of them were attempting to take advantage of their directional properties by using them for transmission as well as reception. Moulded and oil-immersed condensers were finding wide acceptance in amateur stations. Crystal detectors of many varieties were still popular.

During the year 1920, considerable work was done by amateurs on the development of audio amplifiers. Sev-

(Continued on page 105)

A PIONEER

By **PAUL G. WATSON**
Commander, USNR (Ret.)

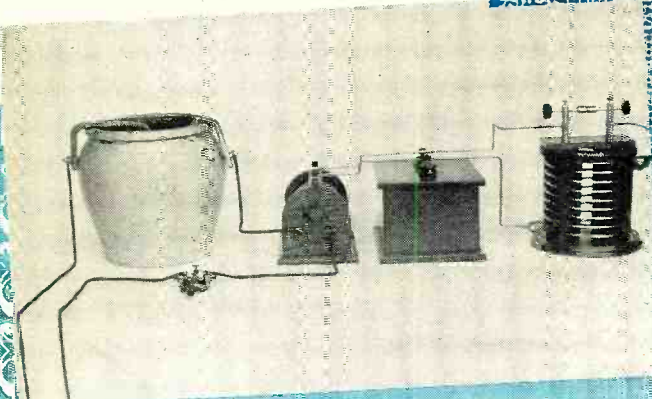
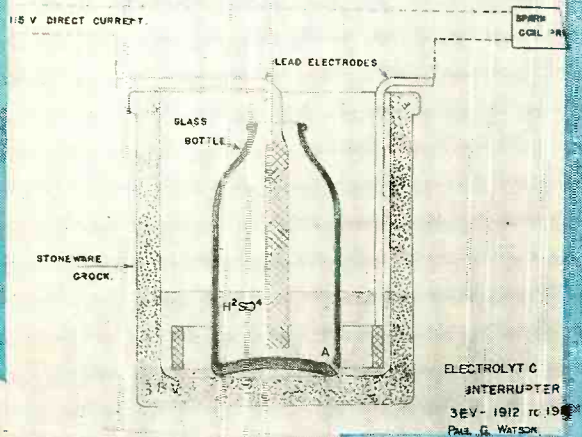

Fig. 1. The original 3BV spark transmitter of 1912, operated from a 115 volt d.c. power line. From the left to right, electrolytic interrupter used to chop d.c. to the coil; spark coil; condenser; and the "helix" with the spark gap located on the top.



↑ Fig. 2. Cross section of electrolytic interrupter. Vaporizing or exploding of acid in hole "A" produced the break in the current.

← Fig. 3. Original elements of 1912 interrupter assembled outside of the crock.

↓ Fig. 4. 1912 cabinet receiver with the galena detector.



1919

Radio amateur, 1910-1933; operator, 1918-1922; electrical engineer, 1923; chief radio inspector U.S. Shipping Board, 1924; radio supervisor (Savannah), 1924-25; U.S. radio inspector (Savannah), 1925-26; radio compass engineer (RCA), 1926; later with private industry and the U.S. Navy.



1954

WHAT was amateur radio like in the early days? What was the equipment like, and what would it do? These are questions put to those of us who lived the early days of radio and in the following pages the writer will give some of his own experiences, beginning in 1910 with just a receiver, a transmitter in 1912, then on through the various stages of development to a home-made superheterodyne receiver and a c.w. transmitter in 1927.

Amateurs got their information from scientific journals and magazines, mostly in picture form with an occasional diagram. There were no strictly "wireless" magazines at the time, although several of the "scientific" magazines ran special departments as the subject of "wireless" grew. From these sources you got all possible information and then made all of your own apparatus except, possibly, the spark coil of the transmitter.

The writer's start in 1910 was made with a single slide tuning coil, electrolytic detector, fixed condensers, and an old telephone receiver. The antenna was large, four wires 90-feet long and 60-feet high. A diagram (Fig. 11) is shown to give an idea as to functioning of this receiver, and its method of tuning.

A detailed description of the receiver elements will help to clarify the picture as to what was known about tuning circuits. The inductance was a coil of about 300 turns of #24 cotton-covered magnet wire on a 3-inch wooden cylinder, well impregnated with orange shellac to hold the coil

Fig. 5. The loose coupler, Crystaoli detector, and Murdock condenser as set up with old receiver (right) in 1916. The transmitter is housed in the cabinet located under table.

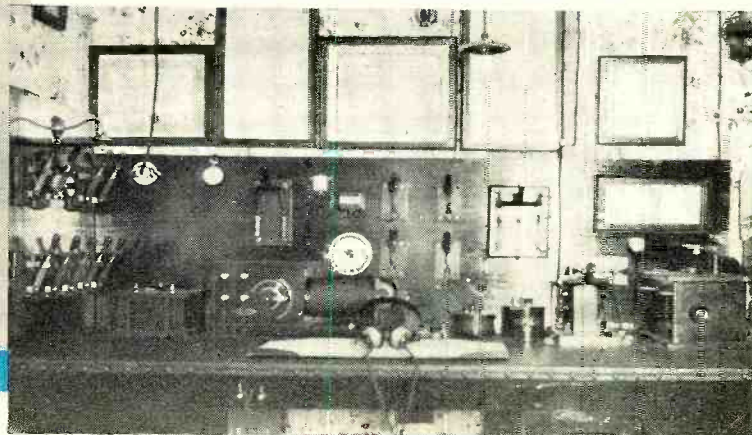

AMATEUR STATION

A trip to nostalgia for the old timer and a glimpse into the past for today's ham. Amateur radio has come a long way!

in place. A bare strip was carefully sanded down the top center of this coil, and a sliding contact arranged on a square bar to contact the individual turns of the coil and provide its inductance variation as one of the tuning elements.

The three condensers and switch shown in the center section of the diagram, with the inductance described, complete the tuning circuit. This capacity unit consisted of a four-point switch and three fixed condensers of wax paper and tinfoil. The first condenser had five leaves, the second ten, and the third twenty leaves, all in a wooden box with the switch on top. Now we come to what would today be called balancing the "L" and "C" values of the circuit. On the first contact of the switch no capacity was across the coil. When the slider tuned to the end of the coil (maximum number of turns), the switch was moved to the second point and the first condenser cut in. Its capacity had been so arranged that it re-established resonance at the same frequency with the slider near the center of the coil, and so with the other two progressively larger condensers, as the slider neared its maximum, cutting in the next larger condenser would bring it back to center position for best tuning adjustment.

The electrolytic detector was, at the time, considered the best and most reliable means of rectifying signals, with the possible exception of de Forest's "Audion" tube. The electrolytic detector used here was composed of a microscopic platinum wire, silver plated, known as "Wollaston wire," the tip end of which was immersed in a small cup of dilute nitric acid. When the cup and the wire were connected in the radio circuit, slight gas polarization collected on the tip of the wire, giving unilateral conductivity and rectification of signals which became audible in the headphones.

Today, all this sounds very crude, but it was a reasonably close copy of *United Wireless'* Type "D" receiver, the best of its kind in the commercial field at the time, and differed only as to the type detector and condenser, and the fact that it had only one slide instead of two.

So we listened on the air for a year or so with this gear, when the urge to "get on the air" hit with a bang. Early in

Fig. 6. The 1919 station with the inductively-coupled, rotary spark transmitter and the loose-coupled receiver with its Crystaoli detector. See Fig. 7 for photo of the transmitter parts.

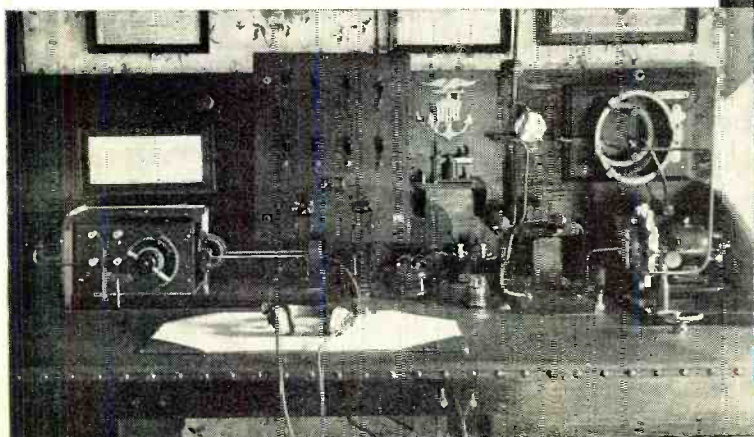

July, 1954

Fig. 7. The 1919 transmitter in display cabinet, oscillation transformer, rotary gap and motor, "send-receive" switch and key.

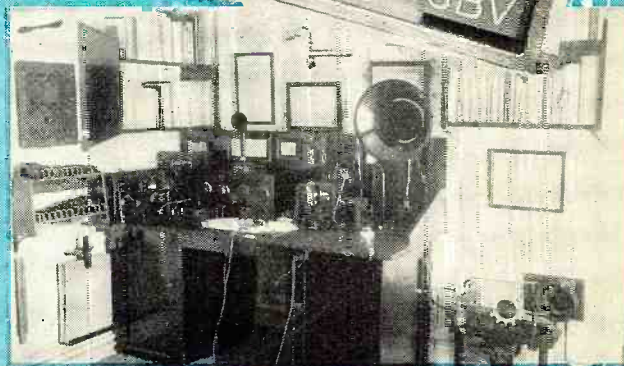
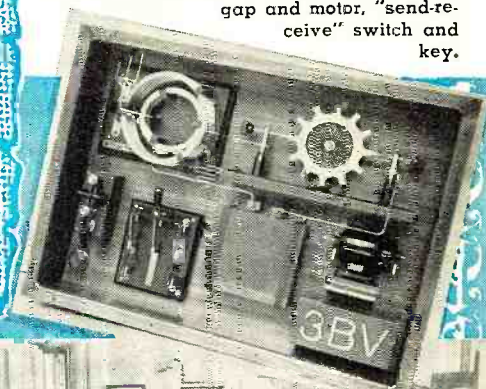

Fig. 8. Station in June, 1922—all home-made gear. Left to right, honeycomb coil receiver, variometer receiver in rear center, detector panel with "Audotron" tube at right, two-stage audio amplifier in corner, and the spark on the floor at the end of the table.

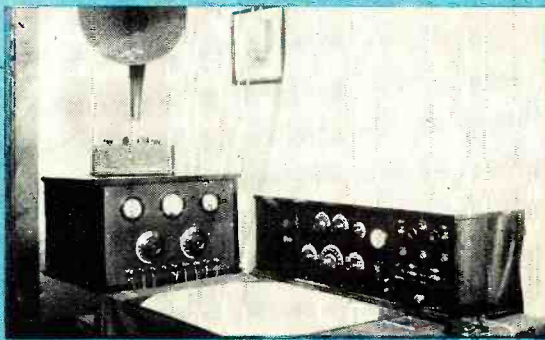
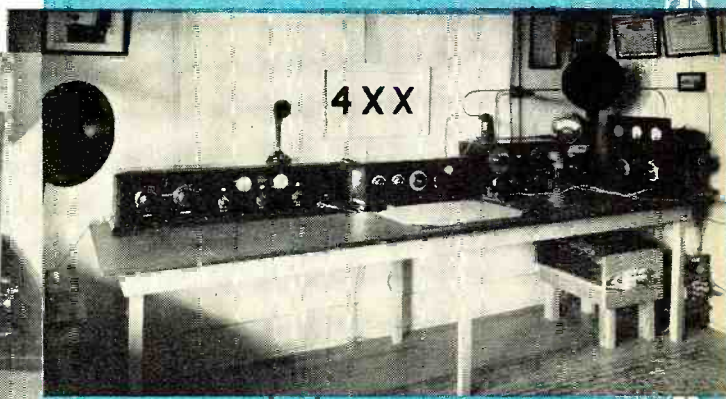

Fig. 9. 4EO, 4ZD, 4XX 100 watt transmitter with honeycomb coil receiver at Savannah, Georgia in 1923.

Fig. 10. 4XX station in Savannah, Ga. in 1927. The 100 watt transmitter is at right, then CM 294 Navy receiver, s.w. regenerative receiver under callsign, and (left) the 20 to 800 meter, 10-tube superhet.



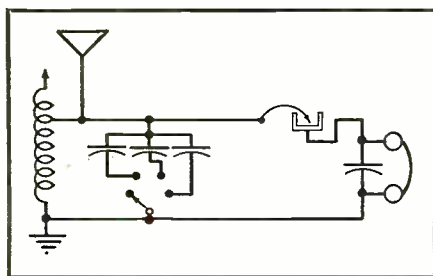

Fig. 11. Single slide tuner circuit as used in the author's 1910 receiver. The early version used an electrolytic detector which was later replaced by a galena crystal.

1912 a one inch "Bull Dog" spark coil was purchased and, along with a fellow experimenter, we set out to build a "sending set." This first transmitter was very simple, an old *Western Union* telegraph key was connected between eight dry cells and the primary of the coil, a spark gap was connected across the secondary, one side of the gap was grounded, and the other side connected to the antenna. After fixing up the antenna insulation several times, signals were heard a quarter mile away (in dry weather). The entire antenna insulation consisted of unglazed porcelain tubes and cleats used in house wiring, and the station was put on an "all weather" basis by boiling all the porcelains in red sealing wax and paraffin.

Now we were on the air, with a little squeaky spark note generated by the coil vibrator. We listened to a lot of the "big boys" growl and gurgle with notes resembling everything from a bad power leak to a rusty gate hinge, but they had "power" to get through. (Sounds like something I heard on 80-meter phone this past week.)

We were all "power" minded and when an article came to hand showing a de Forest station with plate glass condensers and a "helix" to tune with, that was for us, as it was supposed to double your range.

A condenser was made by cleaning off several glass photo plates, shellack-

ing tinfoil on each side an inch from the edge, and when the stack was completed tying the whole bundle with cotton tape and immersing it in mineral oil, then placing the whole unit in a box.

The "helix" previously mentioned was the tuning inductance, 10 turns of #6 bare copper wire spaced $\frac{3}{4}$ inch between turns on an 8-inch diameter wood column support. It was used as a common inductance in both the antenna and the spark circuit, tuning being accomplished by moving either the spark circuit clip, or that of the antenna, or both if needed after the proper number of condenser plates had been determined.

What an improvement this made. My friend and I could now tune out each other's signal by moving our sliders forty turns either side of the maximum point.

In 1912, alternating current was available in very few places and certainly not in the little town of West Chester, Pa. where all this "scientific" development was taking place. We wanted "power" and we had power available in the form of 115-volt direct current for house lighting. We already had tuned transmitters so during the summer of 1912 an electrolytic interrupter was made to work the transmitter directly from the 115-volt d.c. line. The only change necessary in the apparatus was the bridging out of the mechanical vibrator on the spark coil and the connection of the key and the coil primary through the electrolytic interrupter to the power line.

Fortunately all of the original apparatus of this transmitter has survived the 42-year gap since it was first assembled and is shown in Fig. 1 wired as it was in 1912 for use on the 115-volt d.c. line. The only thing missing from the picture is the two clips in the helix for antenna and ground connection.

In 1912 we did not have TVI, but if anybody except ourselves thought our connecting a transmitter, drawing 10 amperes, to the power lines was a good

idea they did not say so. In fact the local paper ran an editorial on how we had ruined Edison's wonderful invention. People, not scientifically minded, who lived within a block of our home objected to their lights blinking. When the power company checked a house on our street they found the voltage dropped from 115 to 90 when we opened up. In our own home, in addition to the blinking lights, there was the problem of odor from the decomposition of sulphuric acid, and on one occasion a broken crock dumped a gallon of acid solution on my bedroom floor at 2 a.m. This gradually worked through the floor and dripped on the kitchen range below. My mother did not like the beautiful orange color of her range the next morning.

What was this devilish device that caused so much trouble? It is shown at the left of Fig. 1 as it was used in 1912. Fig. 2 is a cross-section view, and Fig. 3 a picture of the actual elements used in 1912 to pulsate the 115-volt direct current to the coil. It consisted of a stoneware crock of about two gallons capacity, filled to a depth of 4 inches with a sulphuric acid solution. A quart milk bottle was drilled with a file end at point "A" (Fig. 2) to about $\frac{1}{16}$ inch diameter and was then placed in the acid in the crock. A lead pipe electrode contacted the acid inside the bottle and another electrode was placed in the acid in the crock. By this arrangement, the only electrical connection between the two electrodes was through the small column of acid in hole "A" of the bottle. When the 10 ampere current passed through this column of acid it promptly vaporized (exploded is a better word) and thereby opened the circuit. The acid then fell together, closed the circuit, and the cycle repeated itself as long as current flowed.

In spite of all the difficulties, we got going with the interrupter setting in a lead-lined box and by operating only in daylight or early morning hours. Just

(Continued on page 89)

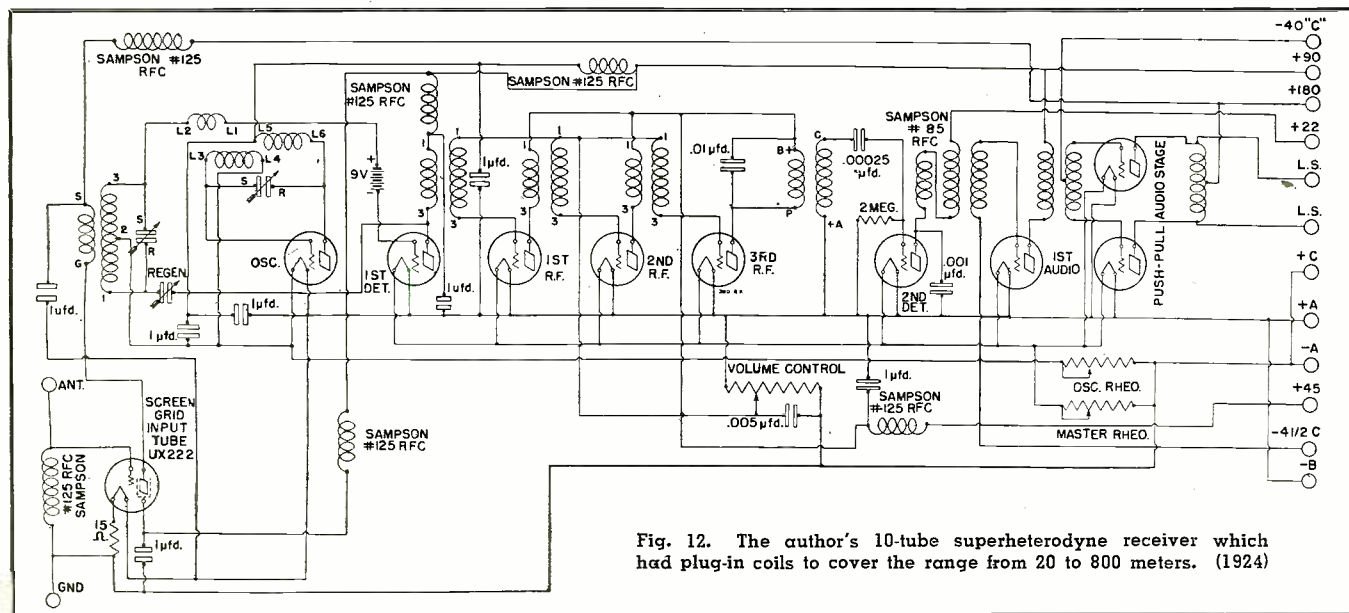

Fig. 12. The author's 10-tube superheterodyne receiver which had plug-in coils to cover the range from 20 to 800 meters. (1924)

A SIMPLE GEIGER COUNTER

By

DR. HARRY R. FECHTER
Stanford Research Institute

and

DR. M. R. BOYD
General Electric Research Lab.

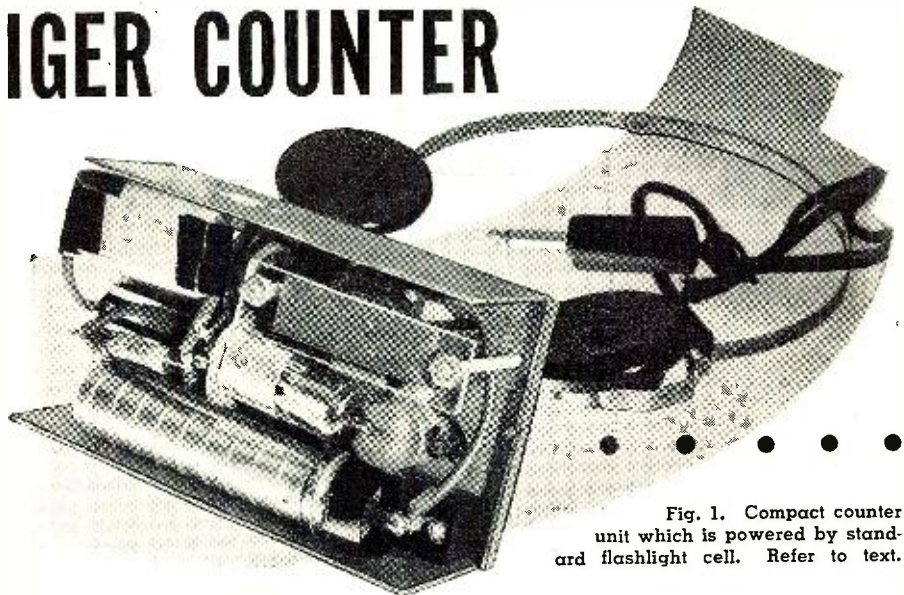

Fig. 1. Compact counter unit which is powered by standard flashlight cell. Refer to text.

OCCASIONALLY one has need of a simple, convenient counter to get a qualitative idea of the presence of radiation. On the other hand, one may be interested in the Geiger counter as a system. This counter may be built inexpensively from parts found in most experimenters' homes. We have used this counter to measure activity in the experimental physics area at the Hansen-High-Energy Physics laboratory (Stanford University) after conducting electron scattering experiments. It has also been an interesting companion on several prospecting trips.

There are several unique features of technical interest (Fig. 2). The high voltage supply uses a minimum of parts. It is built with a *Microswitch* (or equivalent), an ordinary speaker output transformer, an easily-made spark gap, and a 1.5 volt flashlight cell which is also used to heat the amplifier filament. With simple mechanical switching it delivers 700 to 1000 volts for the Geiger tube. The substitution of manpower for expensive batteries is a special convenience if one is using the counter for prospecting.

The spark gap construction is somewhat arbitrary. We found it convenient to cut an inch of lucite from a 1" diameter cylindrical rod. A quarter inch hole in the side allowed room for the gap which was made by tapping in at right angles to the quarter inch hole for two 6/32 bolts. The 6/32 bolts were filed and stoned to pin point sharpness (see Fig. 4). The points are set about .2 mm apart, but this adjustment is not too critical and should be experimented with. The base of the lucite cylinder is tapped for mounting.

To operate, one closes the *Microswitch* 10 or 12 times. The large induced voltage in the secondary of the output transformer breaks down the gap and adds charge to the condenser C_1 at each switching. This gap action is also self rectifying and we thus eliminate a rectifier tube. One listens in the phones for the appearance of counts either from cosmic ray mu-mesons, or electrons, or the gamma rays from a watch with a luminous dial. The charging process is discontinued before the voltage builds up beyond the Geiger plateau (see Fig. 3). If the tube is over-voltaged, one hears

A compact and light counter in which a flashlight battery is used in a new circuit to generate 1000 volts for the Geiger tube. A storage system is used to permit operation with very small current drain. Standard parts are used.

many more than normal counts during the charging. Repeated over-voltage shortens the tube life (approximately 10^9 counts) or damages it. The condenser C_1 is fairly well isolated on the Geiger tube side and the charge in it will now run the counter from 5 to 30 minutes, depending on the quality of components and, somewhat, on the humidity. An occasional push on the *Microswitch* will allow operation to continue. C_1 is a .05 μ fd., 600 volt *Sprague* unit; the tube socket is Isolantite. When a particle passes through the counter, a current flows in the direction of the arrow (Fig. 2) and a fairly loud click is heard in the phones.

The counter can be housed in any convenient way, keeping the high voltage circuit well insulated from other parts. It can be built in a very small space if desired (Fig. 1).

Fig. 2. Complete schematic of Geiger counter. It requires few parts and is small.

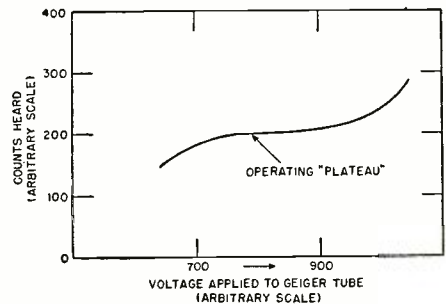
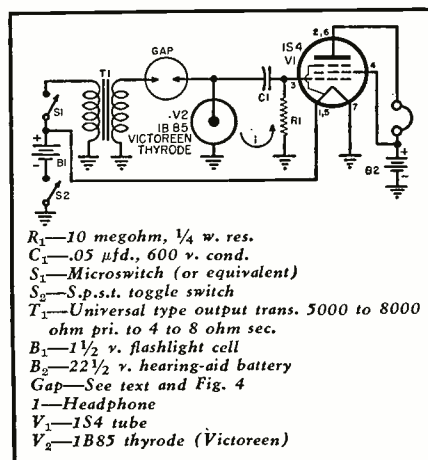
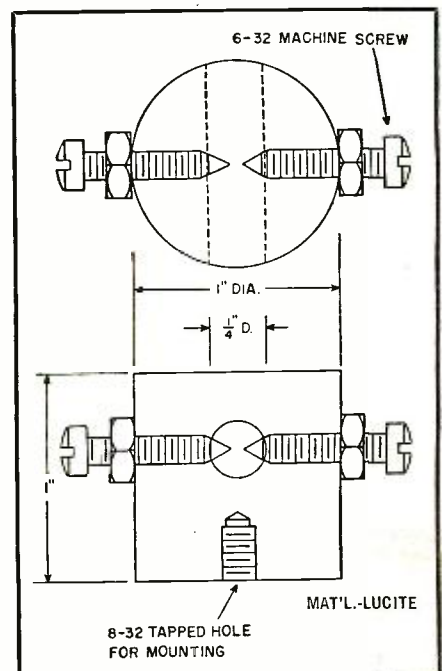
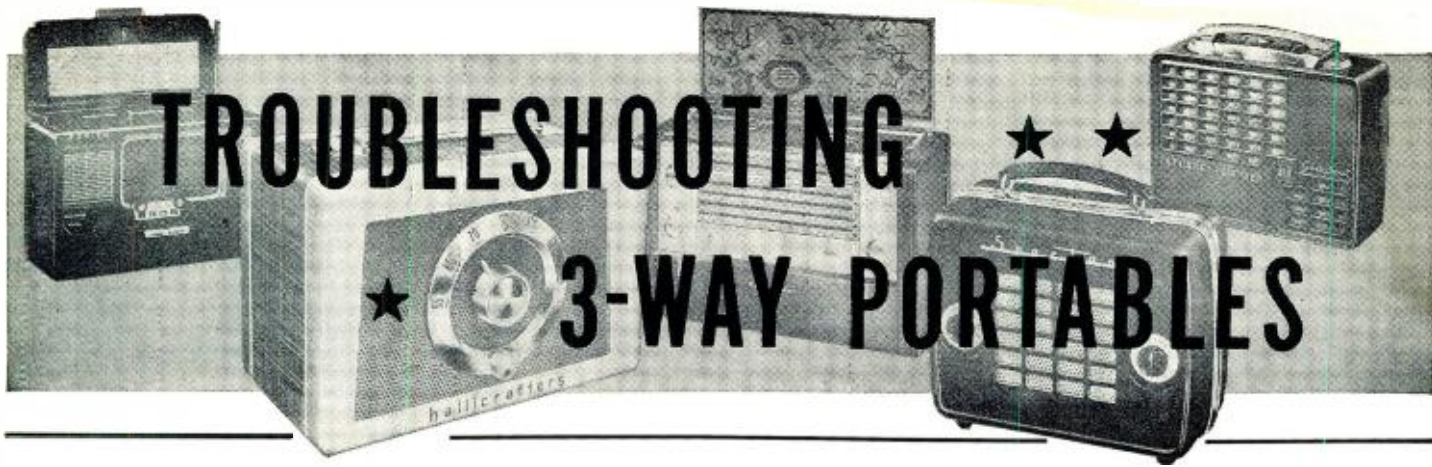

Fig. 4. Mechanical details of the "gap."





TROUBLESHOOTING ★ ★ 3-WAY PORTABLES

By **JAMES A. McROBERTS**

The greatest single source of trouble in portable radios is the power supply. Here are some helpful hints for servicing and checking the major types.

THREE-WAY portable radios have some fundamental peculiarities which the troubleshooter should bear in mind, namely:

1. On power-line operation, a half-wave rectifier rectifies a.c. if used or passes d.c. if the polarity is correct. The rectifier may be a tube type or a selenium type.

2. The rectified output feeds a filter which may be disconnected for battery operation. Batteries act as electrolytic condensers if in good condition.

3. The filaments of the signal tubes are series-connected for power-line duty, but the plates and screens are fed with d.c. from the rectifier via a filter and dropping resistor. The rectifier is fed with power for its heater from the power line directly or through a dropping resistor such as a line cord or ballast.

4. Battery voltages are ordinarily less than those supplied by the power supply.

5. Signal pickup is aided by the power-line connection; the loop only is available in portable service.

A schematic of a typical 3-way portable is shown in Fig. 1. In Figs. 2 and 4 this same circuit is shown with battery supply only and with power-line operation only, respectively. The reader should note that the rectifier and filter circuits are cut out of the circuit in battery operation. The set is strictly a portable only in battery service; even the "A" and "B" batteries have their own sections on the "on-off" switch.

Switching to power-line operation brings into existence two separate "A" circuits—the "A" circuit of the signal tubes and the rectifier heater circuit.

Series-filament operation has another peculiarity. The bypass resistors R_1 , R_2 , R_3 , and R_4 serve to shunt the "B" current drawn by each tube directly to "B—" so that this current does not pass through the other fila-

ments and overheat them. Always replace these resistors with others of the same wattage and resistance. The filaments also have definite plus and minus terminals, and the negative is connected internally to the suppressor grid; therefore, do not interchange connections. Note, too, that the series arrangement is in a definite order with the audio output being the most positive, the i.f. next, then the r.f. stage if present, with the converter and detector—first audio following in order.

Troubleshooting

A major key to troubleshooting 3-way portables is the different power supplies. Test on a.c. and on battery. You will have the following cases:

1. The set does not work on either power or battery. Something is wrong in the signal part of the set or the series-filament chain is broken. Test by tube substitution or by voltmeter measurement with the set on. *Do not use an ohmmeter; the result may be more burnt-out filaments.* Other possibilities are bad "on-off" switch or power changeover switch, or broken connections.

First get the filament string lighted (check with the voltmeter); then check the "B+" bus, fixing any breaks or shorts. After this, repair the signal portion as in any standard set.

2. The set works on battery but not on power. Here you must get your rectifier in operation and delivering an output as the first step. If the rectifier does not light up, test its heater or try another tube. If the heater is OK, trace back the heater line (see Fig. 4) which is directly across the power line except for passing through the changeover switch and a section of the "on-off" switch. In tracing this circuit, you can use an ohmmeter.

Once the tube lights up, the next step is to see if there is an output at its cathode. This should be about 90 to 100 volts ordinarily. If the voltage is low, a new tube may be needed or there may be a short circuit in the filter. After the filter is checked and found to have an output, check for "A+" at the set end of resistor R_5 . The voltage here should equal the total series-filament voltage—generally 6 to 9 volts, the voltage of the "A" battery.

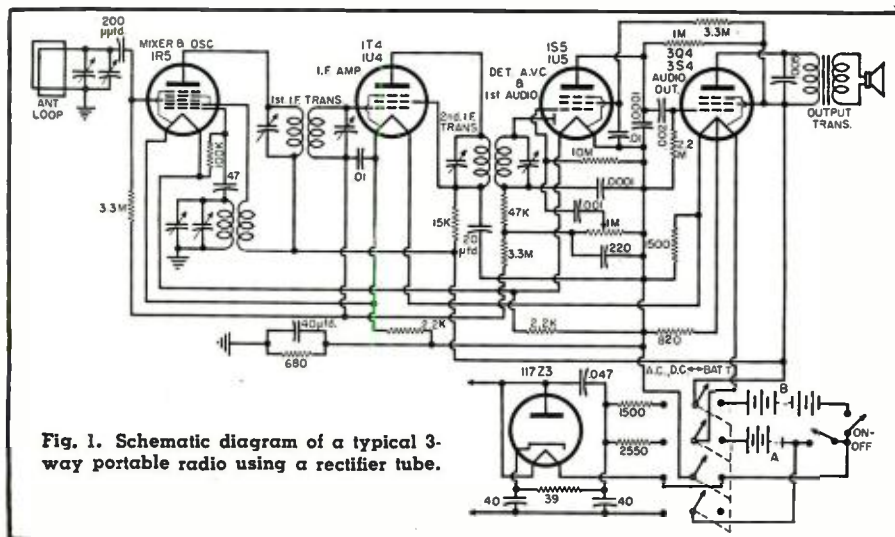

Fig. 1. Schematic diagram of a typical 3-way portable radio using a rectifier tube.

The next test is at the set side of the changeover switch for both "A" and "B" voltages; lack of either means an open or short.

3. Battery operation unsuccessful but power OK. Apart from bad batteries, the "on-off" and changeover switches may be at fault.

Note: The electrolytics are cut out in many sets on battery operation and old batteries can cause oscillation. Oscillation on power-line operation usually points to bad electrolytics.

Fig. 3A shows a typical selenium rectifier circuit used in 3-way sets. Test this circuit for voltage from the input of the filter (point X) to common line (point Z). This should be done with the set on. If no "B+" voltage is present, check for a.c. from point Y to point Z.

Another type of rectifier in which the rectifier heater circuit includes a dropping resistor or ballast is shown in Fig. 3B. Continuity checking with the ohmmeter will show up any trouble in this circuit; of course, the rectifier heater must be operating to secure an output from it. Also shown in Fig. 3B is a pilot lamp in series with "B+". This serves as a pilot light and surge limiter. If there is a short circuit in the set, this pilot lamp will also act as a fuse—so check for a short before putting in a new bulb and hoping! Fig. 3C shows an alternate arrangement for the pilot lamp.

Quite a number of 3-way sets use the series connection of filaments for power-line operation, but switch all signal-tube filaments to parallel connection for battery duty. Probably the best method of troubleshooting this type of circuit is to test it on power with the voltmeter. Starting from the rectifier cathode, proceed to the switch side of the "A+" dropping resistor and from there to the set side of the changeover switch, to the first filament, to the second filament, and so on to "A—" and back through the changeover switch to the power-supply common, usually negative. With the filament string working, the "B+" can be straightened out and then the signal part of the set. The signal part of the set will be easier to repair (in most cases) when operating from a battery supply.

The same rectifier variations may be expected in parallel-on-battery types as in the series-on-battery types. The use of a pilot lamp as a surge-limiting resistor will also be encountered in many of these sets. Naturally, if the set operates on battery the trouble is in the power supply.

To summarize then, first find out if the set will operate on either power supply. Then get the filament chain going on battery operation if possible. Next, test out the power supply starting with the rectifier tube heater circuit. Follow by the testing of (and repair if needed) the "B+" supply and the "A+" supply in the power part of the set and the changeover switch. From this point, test out the "B+" supply to each electrode, and thence,

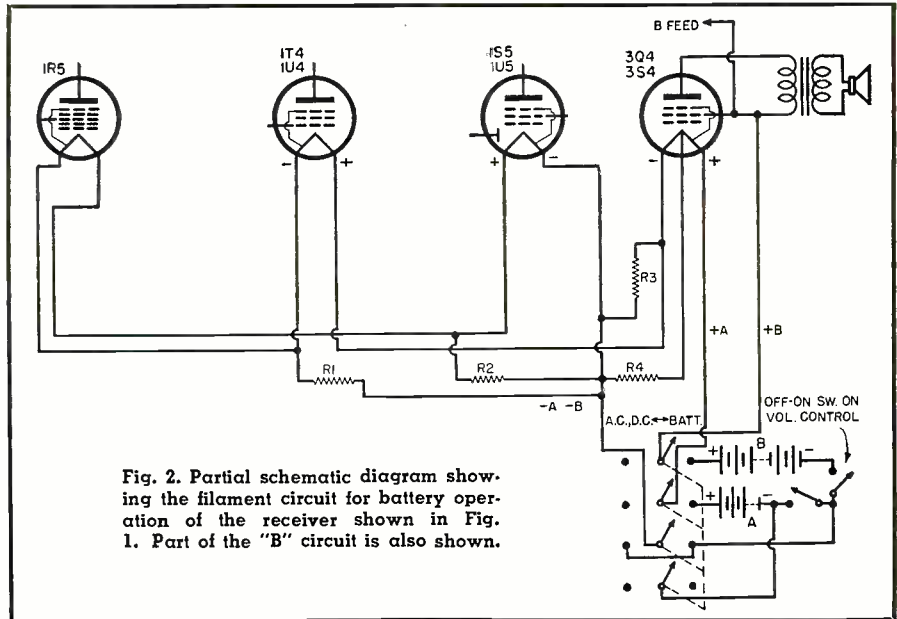

Fig. 2. Partial schematic diagram showing the filament circuit for battery operation of the receiver shown in Fig. 1. Part of the "B" circuit is also shown.

check the purely signal troubles like mistuning, shorted turns in an i.f. can, etc.

Many portable 3-way receivers use printed circuitry, and it is important when servicing such sets to consult the manufacturer's service notes (where available) for peculiarities in the circuit wiring. Also, when changing components on printed-circuit chassis, never use a large wattage soldering iron (or gun), and never apply heat to any component for too long. This is particularly important with chassis using copper-clad wiring where heat may cause peeling.

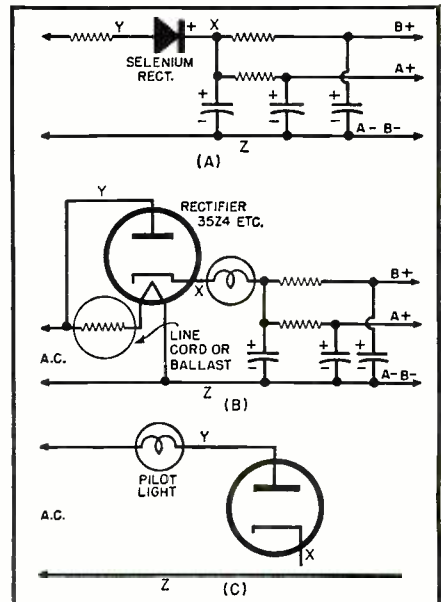

Fig. 3. Rectifier variations used in 3-way portables. (A) Circuit using a selenium rectifier, probably the most common today; (B) circuit using a rectifier vacuum tube with a dropping resistor in series with the heater to provide the proper operating voltage for the tube. (C) shows an alternate hookup for the pilot lamp in circuit (B).

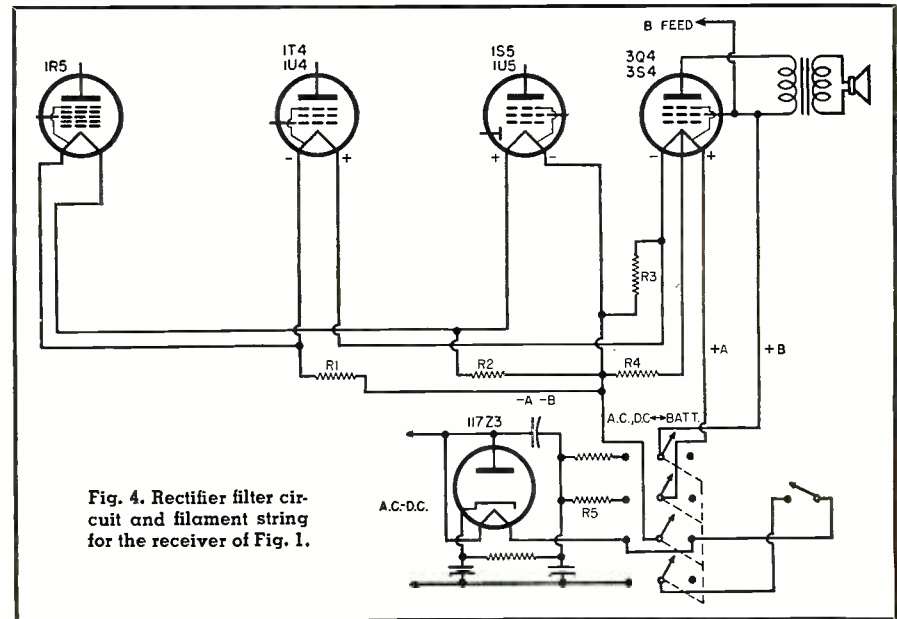

Fig. 4. Rectifier filter circuit and filament string for the receiver of Fig. 1.

2 METERS IN THE FAMILY CAR

By WALTER S. ROGERS, W1DF5

IT IS an imposition for a ham to mutilate the family car with a two-meter mobile installation since it is not at all necessary to make structural changes on the auto with the system to be described here. One ham who made a thorough, police-like installation sacrificed \$400.00 when he came to trade in his car. In addition such jury rigs certainly do not add to the convenience and beauty of the family bus—which must serve many purposes other than housing radio gear.

Two meters is becoming one of the principal CD city communications bands. When W1DF5 was to go on with a relatively new car, many possibilities were investigated and what was finally adopted by W1DF5, W1FBL, W1MAR, and others has proved to have many advantages over a permanent installation.

There are two major considerations involved—antenna and power take-off. We have *Gonset* "Communicators" which are compact, single-cabinet units that work well on 117-volt, 60-cycle a.c. as well as on 6-volt d.c. No matter how good the rig, it won't get out worth a darn without a good antenna. The usual hole in the roof was ruled out. Complicated brackets are too slow to move from car to car as are those mounted on the bumpers, etc. Forcing of the rubber in the door jamb might make the car leak cold air during the winter as well as permit the antenna to drop every time the door was opened.

These restrictions led to the idea that a lead must be made from the outside to the rig, thus a window must be opened just a bit to allow for a small window adapter which is made to fit the nearly-closed door glass. This is surprisingly easy to do, as shown in Fig. 1. As for the antenna, the author's Navy experience showed that the ground plane has certain characteristics which are particularly valuable for mobile operations. Mechanically it makes possible a most compact antenna, thus a vertical quarter-wave ground plane antenna was adopted.

RG/8-U was chosen as the feed cable since the losses are a bit less than the smaller RG/59-U. This 52-ohm impedance suggested that rather than four radials offering an antenna impedance of about 34 ohms, two radials would give a slightly higher value as well as offering less antenna to hit passing branches or the door of the garage. The general dimensions, given in Fig. 2, are not critical and work over the entire band.

For power, it was decided that the rig should operate in any car with a 6-volt electrical system. Thus special

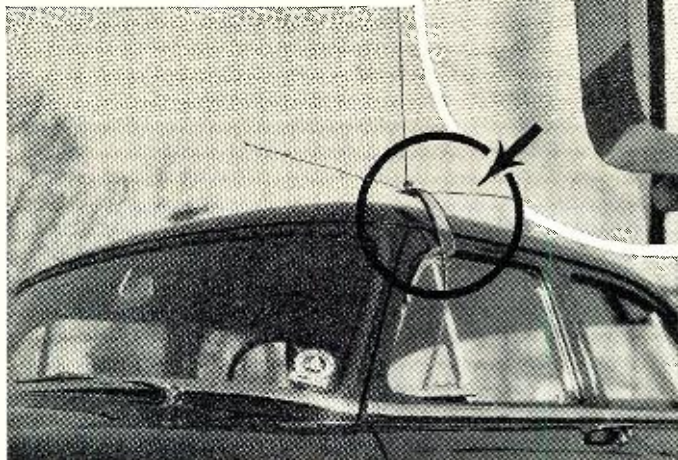

Fig. 1. The vertical ground plane in operating position—note lead through front window. Above is close-up of the metal bracket and fitting which must be stiff enough to retain shape in use.



Avoid mutilation of the family car by adopting this means of installing your two-meter rig and its antenna system.

or permanent fittings would not be required. During an emergency my car might go dead. Since almost every car has a cigarette lighter, why not use one of those emergency drop light plugs—or trickle charger plugs—such as the "Monowatt." This plug, attached to the *Gonset* 6-volt d.c. cord, is all that is necessary.

To build the antenna using the *Gonset* whip requires a few parts. A piece of aluminum, brass, or stainless steel, in my case about 2" x 15" x 1/16", plus two fittings—one 83-1R (SO239) for the antenna and one 83-1SP (PL259) cable connector to match the *Gonset* was needed. In addition you will need some #10 or #12 copper wire (the author used tinned copper because it looks better), about 6-feet of RG/8-U,

a few 4-48 machine screws and nuts, and some plastic electrician's tape. Fig. 3 shows the mounting of the antenna connector. The RG/8-U is grounded to one of the connector screws and taped after the center lead is fastened to the connector.

The flat metal strip is then carefully bent to fit the car. The antenna and ground plane rods should just clear the car top so that they will not hit—thus serving to make the metal car top part of the ground plane. It may be desirable to add some tape where the metal passes through the door so that the paint will be protected from scratches. The RG/8-U may be led in through the same window or through the forward section, as shown in Fig. 1.

In use, the equipment is either set on the seat alongside the driver so that he or a passenger can operate it or set into a light frame made of wood which rests on the floor of the car. Two parallel pieces of light wood, about 1/2" x 6", keep the equipment from rolling.

This flexible installation is so easy to shift to any car and to dismount for an a.c. installation that it fits into CD operations most conveniently. Resistor plugs were installed in my car, but any car with broadcast radio receiver quieting is usually all that is needed for city operation.

Our operations with this type of installation have been surprisingly good. We can more than cover our city. Above all, it is an efficient installation with no mutilation of the car which might, and usually does, affect its trade-in value.

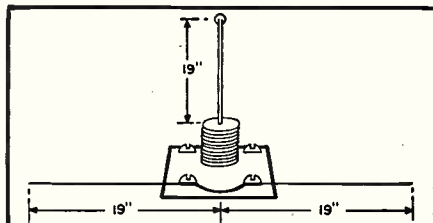

Fig. 2. Over-all dimensions of antenna. For *Gonset* whip, mount thread up. With home-built whip mount below for 90 degree elbow and a RG/8-U feed cable connector.

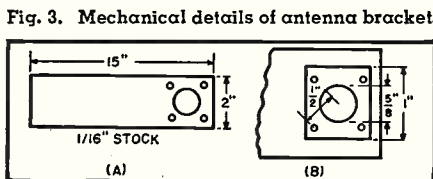

Fig. 3. Mechanical details of antenna bracket.

A 35-WATT "INFINITE FEEDBACK" AUDIO AMPLIFIER

By **CHARLES P. BOEGLI**
Cincinnati Research Company



Fig. 1. The rear view of the "infinite feedback" amplifier. The amplifier and power supply are built on separate chassis but housed together.

A rather novel circuit—it incorporates, in a single compact design, both positive and negative feedback.

DURING the last six years advances in high-quality sound reproduction have been most marked. Phonograph pickups now available at modest cost track with forces that would have seemed impossibly low only a short time ago, and have responses wider and smoother than those obtainable from the most expensive units of earlier days. Speakers and their enclosures are being developed at almost as rapid a rate.

As far as amplifiers are concerned, several recent noteworthy circuits have frequency responses much wider and distortion levels much lower than were afforded even by laboratory amplifiers of a decade ago. The excellent performance of these circuits is generally obtained by relatively large amounts of negative feedback over at least three stages. Instability is usually avoided by various novel means, such as the direct coupling of several stages within the loop. The resulting circuits often need to be constructed with accurately calibrated components and sometimes require some adjustment for best performance; these extremes are necessary for reasons that will become evident later in this article.

In any amplifier employing large amounts of negative feedback over several stages, the frequency response of that part within the loop must be very carefully controlled. Almost without exception, the final circuits display over-all frequency responses much wider than are required for top-quality reproduction. The *object* is to attain low distortion and low output impedance—the *penalty* is the wide frequency response. As a matter of fact, an entire reproducer system does not need a flat response below 16 cps or over 30,000 cps but the distortion must be quite low and the output impedance must be small—the latter especially if the speaker is one of low efficiency.

Actually, the frequency response and output impedance of an amplifier are not independent when the unit is loaded with a speaker. An amplifier of high output impedance and flat response with a resistance load will show a very uneven response, particularly in the bass region, when connected to a speaker.

The lower limit to the output impedance of the amplifier would seem to be a negative resistance equal to the d.c. resistance of the speaker voice coil in series with the speaker lines and the output transformer secondary. Even with this negative resistance the speaker cone could conceivably make some undesirable excursions because the speaker is not 100% efficient in converting electrical to mechanical energy and *vice versa*. In practice, such large negative impedances are difficult to realize with an amplifier of low distortion and good stability. Granting that they might be obtained, they might nevertheless be undesirable, for the large error-correcting voltage appearing within the amplifier in case the cone made undesirable movements would undoubtedly overload the amplifier (unless it had enormous reserve power) and cause considerable harmon-

ic distortion. A lower limit to the output impedance seems necessary, but the magnitude of this limit depends upon many factors, among them the power-handling capacities of the amplifier and the efficiency of the speaker.

The amplifier covered in this article was originally intended to have approximately zero output impedance along with negligible distortion and adequate frequency response. These goals have been accomplished with a simple and trouble-free circuit, requiring no precision components or delicate adjustments, and making use of both negative and positive feedback. The principle is well known but the manner of utilizing it in this amplifier is considered to be novel and simpler than that of previously-designed circuits.

The Amplifier

The reduction of distortion effected by negative feedback in any amplifier is, to a first approximation, directly proportional to the gain reduction¹:

$$\frac{A'}{A} = \frac{1}{1 - \beta A} \approx \frac{D'}{D} \quad (1)$$

where β is the feedback factor (negative for negative feedback), A and D are the amplification and distortion of the amplifier without feedback, and A' and D' are the same characteristics with feedback. Distortion reduction is thus dependent not only upon the feedback factor but also on the original amplification A . The output transformer of an audio amplifier acts as a step-down unit as far as voltage is concerned; if it is to be part of the

Fig. 2. Block diagram of amplifier with two feedback loops. See discussion in article.

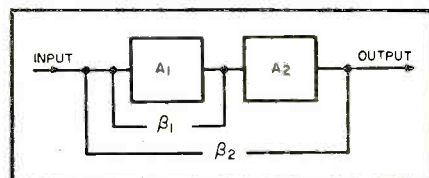

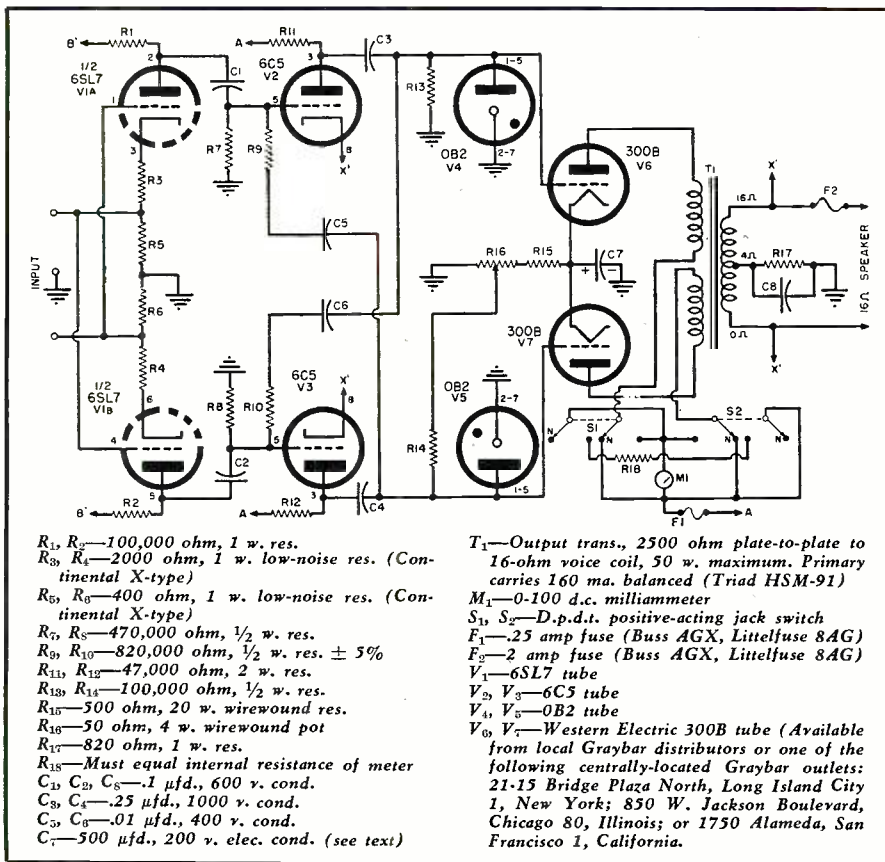

Fig. 3. Complete schematic of the "infinite feedback" amplifier. See Fig. 5 as well.

feedback loop a worthwhile reduction in distortion can be effected only by including a fairly large number of amplifier stages within the same loop. Avoiding oscillation in multistage amplifiers with over-all feedback, however, poses a very difficult problem, which is solved in such circuits as the Williamson by using direct coupling between at least two of the stages to eliminate part of the phase shift caused by ordinary RC interstage coupling.

The amplifier to be described accomplishes the same result with just two stages, namely, driver and power output. By means of positive feedback the gain of the driver stage is increased approximately to infinity; that is, if the negative feedback were removed the driver would oscillate. This principle has certainly been used before² but generally in the design of cheap amplifiers. Its application to high-quality amplifiers seems largely to have been overlooked.

The gain of an amplifier of this type is²:

$$A = \frac{A_1 A_2}{1 - A_1 \beta_1 - A_1 A_2 \beta_2} \dots \dots (2)$$

where the symbols A and β represent the amplification and feedback factors shown in Fig. 2. If the driver stage is caused to oscillate, then A₁β₁ is equal to 1.0 and the equation simplifies to

$$A = - \frac{1}{\beta_2}$$

For negative feedback β₂ is negative so that the over-all amplification is

the reciprocal of the negative feedback factor. In a single-loop amplifier this result could be obtained only with an infinite gain within the loop. The feedback would then be infinite (in terms of decibels) and for that reason the present amplifier is called the "infinite feedback" amplifier.

The output impedance is: Z₂ =

$$Z_L \frac{1}{\left(1 + \frac{Z_L}{Z_{p2}}\right) \left(1 - \frac{A_1 A_2 \beta_2}{1 - A_1 \beta_1}\right) - \left(1 - A_1 \beta_1\right)} \dots \dots (3)$$

where Z₂ is the observed output impedance, Z_L is the load impedance, and Z_{p2} is the output impedance without feedback. If A₁β₁ = 1.0 then Z₂ = 0; or the amplifier has zero output impedance. The rate of change of Z₂ as A₁β₁ is varied slightly from 1.0, however, depends upon β₂, the amount of negative feedback, and will be smaller as the negative feedback becomes greater.

If the output of such an amplifier is subjected to some voltage disturbance δ (which might arise, for instance, from an unwanted oscillation of the speaker cone or the introduction of distortion in the output stage), then a correcting output of magnitude

$$E_o = \frac{A_1 A_2 \beta_2}{1 - A_1 A_2 \beta_2 - A_1 \beta_1} \delta \dots \dots (4)$$

also appears at the output terminals. When A₁β₁ = 1.0, E_o = -δ, which means that the correcting voltage is equal in magnitude but opposite in sign to the disturbance, or that all dis-

tortion in the output stage is removed and unwanted speaker excursions are eliminated to an extent dependent solely upon the characteristics of the speaker. If A₁β₁ is slightly greater than 1.0 then any disturbances to the output are actually overcorrected. While the speaker damping is improved the distortion becomes worse. When A₁β₁ = 2.0 the distortion is equal to that resulting if the positive feedback were removed entirely.

An amplifier of this type will be unstable (it will oscillate) when the denominator of equation (2) becomes equal to or less than zero, that is, when A₁β₁ + A₁A₂β₂ becomes equal to or greater than 1.0. The stability of the amplifier increases as the quantity A₁β₁ + A₁A₂β₂ becomes smaller. Maximum stability is thus achieved by using as much negative feedback as is conveniently possible. At very low or very high frequencies where, as a result of phase shifts in the negative feedback loop, instability may tend to exist, the positive feedback can be reduced and shifted in phase to keep the sum A₁β₁ + A₁A₂β₂ less than 1.0. It should be noted, however, that with sufficient negative feedback the midrange positive feedback can be greater than unity without instability, which means that within certain limits a perfectly stable negative output impedance can be obtained. In the amplifier to be described the quantity A₁β₁ is made slightly greater than 1.0 and 100% negative feedback is employed. This combination insures minimum distortion and maximum stability, together with an output impedance near zero and an over-all voltage gain near unity. The power gain, however, is quite large.

Since in this type of circuit instability is avoided primarily by regulating the positive feedback, the response of the entire circuit within the negative feedback loop need not be controlled very closely, and the final amplifier may display an extremely low output impedance without necessitating excessively wide frequency response.

Aside from reasons of stability there is a significant advantage in using 100% negative feedback, and this is that the response of the entire amplifier is almost completely independent of the response of that part within the loop. Rather drastic measures may then be employed to eliminate any tendency toward oscillation without effect on the over-all frequency response.

The low output impedance is, of course, limited by the power handling capability of the output stage, which is not affected by the negative feedback. Only a limited amount of power can be drawn by very small load impedances without overloading the output stage, whereupon distortion sets in. The amplifier is thus unable to correct for errors in the output voltage when these errors are large and the load impedance is small, which means that overdriving the speaker will generally result in considerable distortion or other undesirable effects.

Circuit Design

The theoretical reduction of distortion is seldom attained in practice, so every possible step must be taken to improve the quality of the amplifier prior to the introduction of feedback. In this particular version the output tubes are 300B's in straight class-A push-pull operation with 460 volts on the plates. The drivers are 6C5's with a plate supply of approximately 550 volts. To develop full amplifier output each 6C5 must deliver a signal of about 100 volts peak to the grid of the following 300B; the gain of the 6C5 is about 14 so the peak grid signal at the 6C5 is about 100/14 or 7.1 volts.

Some speculation may arise as to why such expensive tubes as 300B's have been used in this amplifier (they cost approximately \$9.00 apiece). It was the object of this work to provide an amplifier of around 30 watts output and 300B's are the only triodes capable of supplying this output in the desirable class-A operation. No doubt some available power tetrodes or pentodes could have been used, connected as triodes, but it has been the writer's observation that results are never as satisfactory as when triodes are used. Part of the problem probably arises from the difficulty of balancing two tetrodes when they have been so connected and making each tube do its share of the work. 6C5's were selected as drivers because they are capable of delivering the required output voltage with very low distortion even in the absence of negative feedback; in this respect they seem to be slightly superior to the more common 6J5's.

Push-pull negative feedback is taken from the secondary of the output transformer to the cathodes of the 6C5's. The entire secondary of the transformer is thus at a d.c. potential of about 8 volts above ground, so the speaker lines must not be grounded at any point. Positive feedback from the plate of each 6C5 to the grid of the other 6C5 is adjusted so the driver stage is oscillating weakly when the negative feedback is removed. A low-cut filter comprised of R_5C_5 in the positive feedback network prevents oscillation at very low frequencies where the over-all negative feedback loop gain begins to fall off and a high-cut filter made up of R_6C_6 and R_7C_7 (where R_6 is the output resistance of the 6C5, C_6 is the capacity at the grid of the 300B, and C_7 is the total capacity at the grid of the 6C5) performs the same functions at high frequencies. Such simple precautions are insufficient unless an output transformer of very high quality is employed, and the sizes of the components in this loop are largely dependent upon the characteristics of the output transformer. Because push-pull negative feedback is taken from two ends of the voice-coil winding of the transformer, the capacities to ground at the two ends must be about equal.

This circuit was constructed with a standard output transformer having 4, 8, and 16-ohm taps on the secondary.

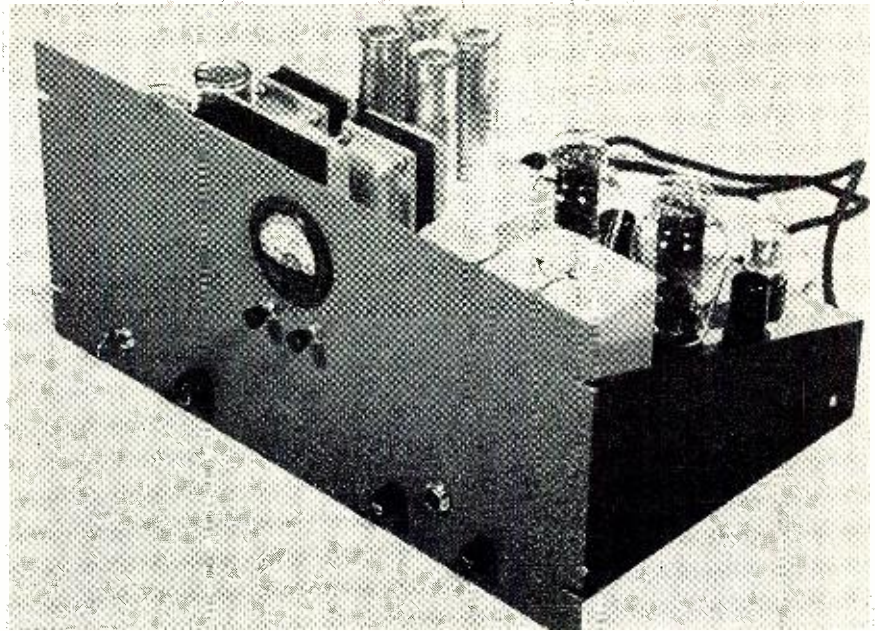

Fig. 4. Front panel view of 35-watt amplifier. The meter is permanently in circuit.

The 4-ohm tap was used as a center-tap and a balanced output was taken from the 0 and 16-ohm taps. This arrangement has been quite adequate, since the d.c. resistances and the output voltages each side of the "center tap" were very well balanced with the transformer used. An 8-ohm speaker, however, is necessarily connected in an unbalanced manner, which may be less satisfactory than when a 16-ohm speaker is attached. For this reason it would be desirable to have a transformer with 4, 8, and 16-ohm *balanced* secondary windings; at present such a transformer is not commercially available.

The inverter is an essential part of the amplifier because it prevents vari-

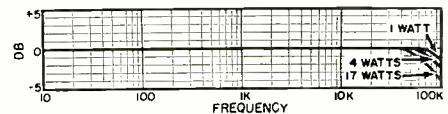

Fig. 5. Response of "infinite feedback" unit.

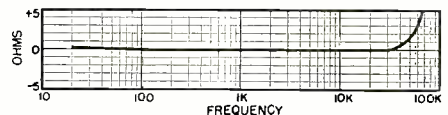
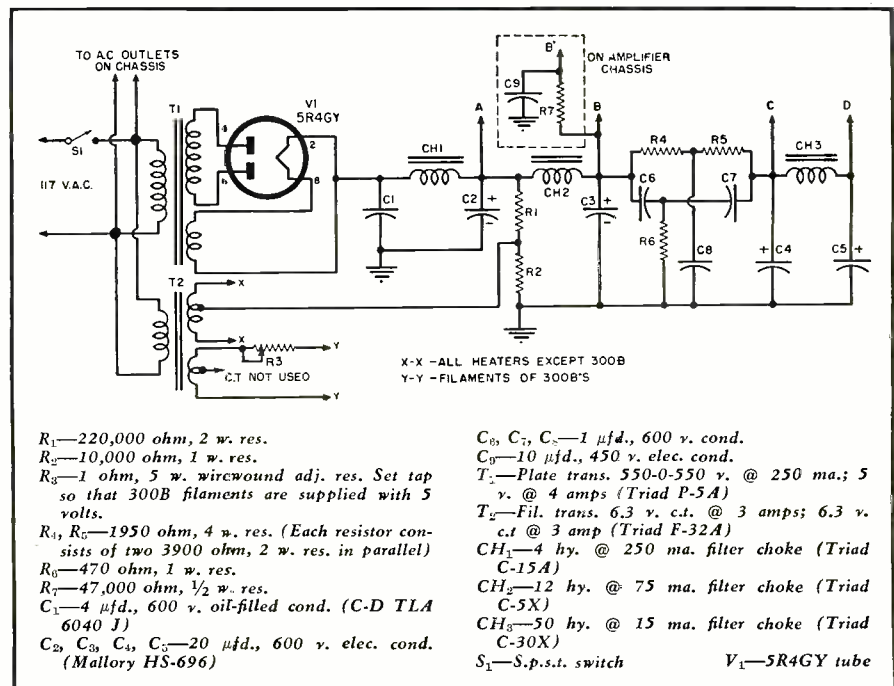

Fig. 6. Output resistance of the amplifier at .78 volt into a speaker of 16 ohms.

ous input sources from influencing the positive feedback. The circuit is the writer's simplification of the cross-coupled amplifier developed by Van

Fig. 7. Power supply diagram. Connections C and D are used for preamp power supply.



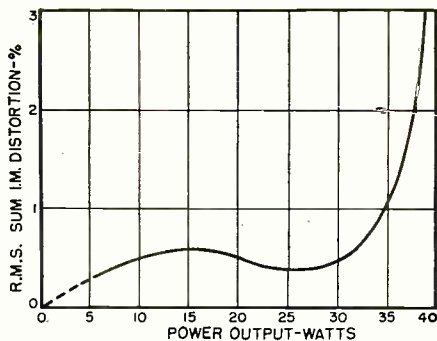

Fig. 8. Intermodulation distortion of the "infinite feedback" amplifier. The resistive load is 16 ohms and input is balanced.

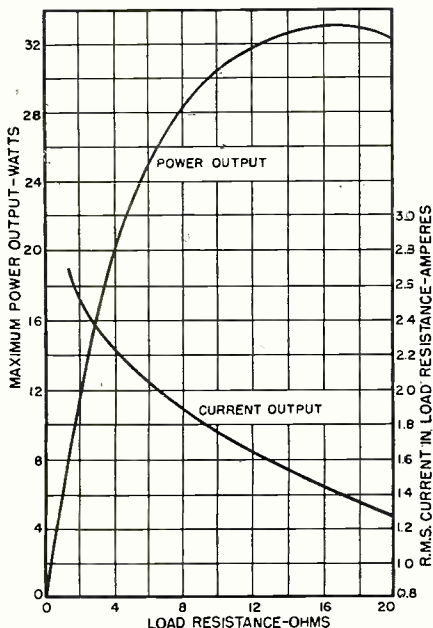

Fig. 9. The calculated maximum power and current delivered by the amplifier into various load resistances. Refer to text.

Scoyoc³ and performs essentially the same function as a line-to-push-pull grid transformer. It has been fully described in a previous article.⁴

The circuit of the complete amplifier is shown in Fig. 3; the parts list describes the components that were used in the experimental model, with

a few exceptions. Only one generally unavailable part has been used in the experimental construction, namely, the 500- μ fd., 200-volt bypass on the 300B cathodes. This condenser may of course be eliminated but it is desirable to use as large a condenser here as possible. A 300- μ fd., 150-volt unit, which is commercially available, would be quite satisfactory.

The circuit diagram of the power supply designed for the experimental model is shown in Fig. 7. It is built on a 7" x 12" x 3" chassis which is a twin to the amplifier chassis. Fig. 1 is an over-all view of the completed amplifier and power supply.

Performance

Fig. 5 shows the frequency responses at various resistive power loads into a 16-ohm resistive load. The response, particularly at high frequencies, is dependent upon the power that must be supplied. It may be remarked at this point that this amplifier falls outside the class of minimum-phase structures; that is, the phase curve cannot be computed from the frequency-response curve. The response curves show that 3 db less than full power is delivered ± 0 db over a range of 16 to 40,000 cps; a tribute to the high quality of the output transformer. Fig. 6 shows the output resistance of the amplifier on the 16-ohm tap as related to the frequency.

The r.m.s. sum intermodulation distortion for frequencies of 60 and 3000 cps (4:1) at different power levels is shown in Fig. 8. Below the point at which the grids of the 300B's are starting to be driven positive, the intermodulation distortion of the entire amplifier is substantially the same as that of the inverter, from which it might be concluded that the power-amplifier stages are practically distortionless. The intermodulation distortion is less than 2% for power levels less than 37.5 watts.

The r.m.s. sum intermodulation distortion is almost always greater than the harmonic distortion, and is a fairly good measure of the cleanness of the output. For advertising purposes some

manufacturers have published figures for various other types of IM distortion measurements (such as the level of the first-order difference tone only) which are much lower than those for r.m.s. sum IM distortion and must not be confused or compared with them.

The output tubes in this amplifier are operated very near their maximum ratings. For this reason a plate-current meter should be provided and the plate currents balanced carefully. The single balancing control designed into the amplifier, when rotated, increases the plate current of one tube at the same time it decreases that of the other. It is sometimes necessary to interchange the positions of the 300B's to arrive at a balance. The zero-signal plate currents of the output tubes are approximately 94 ma. per tube. If the output leads of the amplifier are shorted together the negative feedback is removed and the oscillation of the drivers then tends to drive the grids of the output tubes well into the positive region. 300B's are not intended for operation in this region and will quickly be destroyed by this eventuality. The same type of destruction will occur if the output is effectively short-circuited such as by severely overdriving the speaker. A number of protective devices have been employed to prevent this type of destruction. Not only the plate supply but also the speaker line is fused and 0B2 voltage-regulator tubes are placed across the 300B grids. Of these three precautions the 0B2's are the most effective.

The power-handling capabilities of the output stage are not influenced by negative feedback, which simply attempts to keep the output voltage constant irrespective of changes in the load resistance. Fig. 9 shows the theoretical maximum output power this amplifier can deliver into various load resistances and also the maximum current that will flow in the load. When the output is shorted the current rises to a very high value, and the quick-acting fuse in the output will blow.

The unit requires .43 volt balanced or unbalanced input to be driven to full output. The noise level of the experimental unit measured .005 volt, or 74 db below 35 watts, with input shorted. The damping factor of the amplifier is, of course, infinity.

Because of its low input impedance the amplifier cannot be driven by many of the preamplifiers now in use without special precautions. Fig. 10 illustrates several schemes by which existing preamplifiers may be employed or new units designed.

Fig. 10. Several methods of connecting preamps to the "infinite feedback" amplifier.

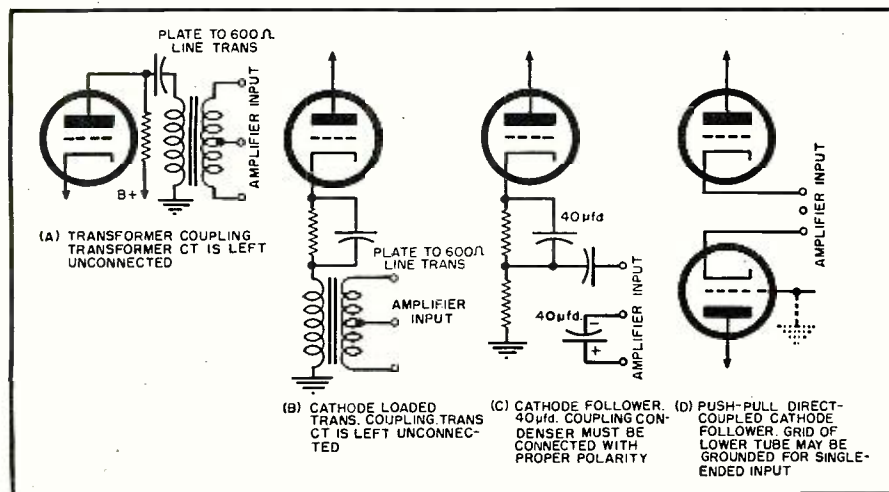

REFERENCES

1. Langford-Smith, F. (ed.): "Radiotron Designer's Handbook," Amalgamated Wireless Valve Co. Pty., Ltd., Fourth Edition, 1952, page 309.
2. Miller, J. M., Jr.: "Combining Positive and Negative Feedback," *Electronics*, March 1950.
3. Van Scoyoc, J. N.: "A Cross Coupled Input and Phase Inverted Circuit," *Radio-Electronic Engineering Edition of RADIO & TELEVISION NEWS*, November 1948.
4. Boegh, C.P.: "Simplified Cross-Coupled Amplifier," *RADIO & TELEVISION NEWS*, May 1954.

AERIAL "PRIVATE EYE" TRACES TV SIGNALS



(Left) Pilot-General Manager Ralph Bykerk at the controls and (Below) Bykerk and Ray Mitchell go over findings with John Kelley, KTNT-TV's assistant engineer.



By TELE-BEAM INDUSTRIES



WHAT happens to television signals when they leave their home antenna high atop a tower and find themselves on their own in a large open space, full of mysterious waves and cross currents? Why are some signals received clear as life 75 miles away while others arrive pale, weak, and ghostlike on nearby screens?

To try and get the answers to these old-as-video questions, a team of TV troubleshooters has taken to the air and actually tracks down signals as they are being telecast. Their findings are proving of great value to television stations, and to jobbers and dealers, as well as to their own business, which is the manufacture of antennas and TV accessories.

The airborne team is composed of Ralph O. Bykerk, owner, and Ray J. Mitchell, sales manager, of *Tele-Beam Industries*, Napa, California—both radio-TV engineers. The air survey was the last resort in a series of tests to find out why, in areas equidistant from telecasting stations and with the same terrain, they would find one town with high signal levels, while in the other direction from the station there was barely enough signal to give a reading on a field strength meter.

First, *Tele-Beam* engineers designed their antennas to go higher in the air to get difficult signals, but this wasn't the answer. Then they mounted 50-foot masts on their station wagons, with antennas, field strength measuring equipment, and even the full equipment of a local amateur station, to make radiation patterns of the TV stations. On a survey in the Puget Sound area they used a boat to fill in the area not accessible by vehicle. Unusual radiation patterns were found, and the great extent of terrain effect was realized, but still the engineers were not satisfied. Then somebody got a brain-wave—why not test the signals in the air, using the *Cessna 170* which the firm maintains for business transportation?

How two enterprising engineers increased receiving antenna sales by supplying TV stations with data on their markets.



Tele-Beam's technical staff swarmed over the aircraft making and spacing antennas, checking ignition noise, static effect, and all the complications of aircraft radio. With completion of the one-meter folded antenna spaced properly under the fuselage, field strength meter, and power converter, the *Tele-Beam* pioneers took off into the blue. While in the air, CAA was contacted regarding the flight plan, and the altitude and pattern of flight. Eventually special permission was obtained for aircraft, pilot, and passengers, and a whole new field was opened.

The company's aerial survey service has, since its first flight over a year ago, proved of great value to many West Coast TV stations in programming for their areas as well as the company. The firm has learned what merchandise to recommend in a given region in the reception area of any TV station tested, and both the company and its dealers can be pretty sure it will *stay* sold. These aerial surveys are made gratis at the request of TV stations. Wholesalers and dealers may participate in the surveys at the discretion of the station.

Here's how an aerial survey would work on hypothetical station USA-TV, channel 10, which is located at an altitude of 904 feet with a 500-foot tower and a 55-foot, 12-bay turnstile—total, 1432 feet above sea level (but to be exact, the pilot flies a course straight toward the center of the turnstile and checks the altimeter):

Disregarding the terrain below, which sometimes rises to 1350 feet or falls off to 600 feet, the pilot flies out the time required at his rate of speed, to be five miles from the tower. Prior

to take-off, aeronautical and topographical maps have been checked to set up local identification marks such as water towers, grain bins, small towns, or even rifle ranges and golf courses.

Starting at the north of the station, or at zero degrees, the pilot flies the five mile circle, calling out every ten degrees—350, 340, 330, etc. Readings are taken at each of these ten degree positions while flying in concentric circles. The second time around, the ground effect is observed and charted. Similar readings are taken at distances of one mile, three miles, 10 miles, and, many times, at 40 miles. Then, when the plane is back on the ground, polar plots are drawn. These polar plots are superimposed in order to develop the final plot or radiation pattern of the station. Actual deviation has been found to be as much as 14 db, while other stations were found to conform very well to design.

Vertical plots are made every 90°, or if the station's chief engineer desires, every 45°, this being done by going to 2000 feet above the center of the turnstile—or in the case of station USA-TV—to an altitude of 3350 feet. At this height the plane turns toward the station and dives earthward at a rate of 2000-feet-per-minute (until the surveyers can almost see the barbs of the barbed wire fences), all the time reading the meter every 100 feet.

All of the information gathered on these aerial survey flights is plotted both on polar paper and aeronautical and topographical maps, so that just what and where the station is transmitting can be checked. In some cases

(Continued on page 104)

ELIMINATION OF R.F. INTERFERENCE IN AUDIO SYSTEMS

By

MAJOR EUGENE F. CORIELL, USAF
Armed Forces Radio Service, New York



Fig. 1. Some of the equipment used in eliminating r.f. pickup in audio gear. From top to bottom: W.E. or Altec 111C repeat coil, Cornell-Dubilier CDA5 decade condenser, and Heathkit RS1 resistance substitution box. See text for application data.

Part 2. Concluding article covers suppression in lines and cables, amplifiers and power supplies, prevention of rectification; and miscellaneous remedies to be tried.

LAST MONTH the problem of r.f. interference in audio systems was discussed as to origins, suppression at the source, and, in part, suppression at the affected gear. It was also pointed out that professional audio installations designed and built in accordance with the best engineering practices should experience little or no trouble from transmitter interference. These two articles are intended to serve as a construction guide as well as a list of corrective measures, and it is hoped they will also be useful for non-professional equipment such as home tape recorders and high-fidelity music systems. Part 1 concluded with a listing of construction precautions and remedies under the heading "Shielding and Grounding." This article describes r.f.-elimination measures under the headings "Lines and Cables," "Amplifiers and Power Supplies," "Prevention of Rectification," and "Miscellaneous Remedies."

Lines and Cables

1. Keep as many as possible of the low-level and line-level circuits balanced to ground. This applies, of course, principally to low impedance circuits. A two-wire line in the presence of r.f. may have a longitudinal voltage impressed between each wire and ground. When the impedance to ground is different for each leg, an r.f. voltage may appear across the pair and therefore across the input of the following circuit element. Reference¹ gives a detailed analysis of longitudinal pickup in audio lines. Some circuits, such as filters and equalizers, are traditionally unbalanced. Where the severity of interfer-

ence warrants the cost, such circuits can be converted to balanced conditions by interposing 1:1 isolation transformers, preferably with electrostatic shields. Also see the section "Miscellaneous Remedies" for other data on unbalanced equalizer circuits.

2. Microphone, turntable pickup head, and other low-level lines should be as short as possible to reduce their antenna action. In portable and field setups where some leeway exists, the microphone cables can be oriented for minimum r.f. interference.

3. For all low-level lines in conduit or in cable bundles, use two-conductor (stranded) shielded cable with insulation over the shield, and with a bare ground wire inside of and in contact with the shield. This wire facilitates connection of the shield to the ground lugs of the various terminating connectors. Typical cable of this type is the *Whitney-Blake* CBS-3-22F. Any cables used for this purpose should have minimum capacitance per foot, and equal capacitance from each circuit conductor to shield in order to maintain optimum balance to ground. The two conductors should be twisted, of course, to reduce electromagnetic pickup.

4. When interference is expected or experienced from higher frequency sources such as communications transmitters (as compared to broadcast plants), try to avoid low-level line lengths which are multiples or sub-multiples of the interfering wavelength. Otherwise, they may become resonant to the r.f., with resulting maximum pickup.

5. Run low-level and line-level cir-

cuits in grounded electric conduit, which has some r.f. shielding effect if all the joints are electrically tight. Rigid conduit is probably better in this respect than "thin-wall" as the former uses threaded connections.

6. Try small r.f. chokes in each leg of the affected low-level and line-level pairs. This is a matter of experiment, as the exact value depends on the circuit impedance and the frequencies to be suppressed. Values upwards of .3 millihenry are suggested. Variable chokes such as the *Grayburne* V-6 and V-25 simplify the necessary selection by trial. Don't overlook the possible effect of chokes on the audio frequency response and other performance characteristics. Remember also that chokes are highly inductive and may require electromagnetic shielding against hum.

7. Use an LC low-pass filter in low-level lines. One very effective form of this device is shown in Fig. 2 and consists of two closely-coupled coils, one in each circuit leg, with condensers across the circuit.² The inductances add for r.f. voltages which, being longitudinal, travel in the same direction on both conductors. The coils and condensers form a low-pass filter which greatly attenuates the r.f. Since audio signal currents travel in opposite directions on each circuit leg, the inductances cancel and have little effect on program material. The filter should be enclosed in a shielded case.

8. Wave traps may also be used in audio lines. Traps differ from low-pass filters in that the former attenuate a narrow band of frequencies and their cut-off frequencies are, therefore, more sharply defined. A trap might be pref-

erable to eliminate an interfering frequency near the desired upper audio limit with minimum effect on the frequency response. This would involve careful and probably experimental determination of component values.

9. It is important to use patch cords with the shield bonded to the plug body at one end only, to avoid troublesome ground loops.

10. Use repeat coils (audio transformers) having an electrostatic shield between windings, to isolate low-level and line-level circuits from their amplifiers. This shield, which should be tied to the main audio ground, reduces the capacity between the primary and secondary windings, which is the principal means whereby r.f. passes through an audio transformer. Examples of this type of unit are the *Western Electric* or *Altec* 111C and the *UTC* A21 transformers.

11. For the same reason, use 1:1 power transformers with electrostatic shields in the a.c. lines feeding amplifiers or complete rack assemblies. An example of this unit is the *Stancor* type P6415. Since this may involve considerable expense in a large installation, such devices should be used only on circuits for which this need is clearly demonstrated.

12. Use line-filter condensers in amplifiers and/or power supplies between each leg of the a.c. power circuit and ground.

13. It may sometimes be necessary to install r.f. filters in a.c. power lines to amplifiers and power supplies. Occasionally a small plug-in filter of the type used to suppress electric shaver and fluorescent lamp noise can be inserted in the wall socket with fair results. Sometimes a larger unit such as the *Cornell-Dubilier* NF 10325 or the one diagrammed in Fig. 1 of Part 1 will do the trick. There may be times when a heavy-duty filter in the main a.c. feeder to the audio equipment room is the best answer. Units of this size may have to be made to order, and in any case, filter manufacturers should be consulted beforehand. These devices reduce the r.f. conducted directly along the power lines to the affected amplifiers. An additional benefit is that lines so filtered *re-radiate* less r.f. (beyond the filter) to be picked up by inductive elements and internal wiring of the audio equipment. Filters should therefore be placed as close to the wall socket or distribution panel as possible, to reduce the radiating length of a.c. wiring between the power outlet and the filter. Installation of filters at distribution panels may require approval of the local authority administering the electric code.

Amplifiers and Power Supplies

1. Use input transformers and filament-plate power transformers having an electrostatic shield between their windings and ground the shield. Power transformers are also available with inverted windings which, like the electrostatic shield, reduce the interwinding capacitance and thereby provide an r.f. barrier. However, the need for

such power transformers is remote in a well-designed audio system except in cases of exceptionally severe interference.

2. Keep the internal r.f. impedance of plate power supplies to a minimum. Electrolytic filter condensers may have appreciable inductance at radio frequencies, which may be reduced by paralleling the filters with small mica condensers.³ This will reduce the magnitude of any r.f. voltages that may appear in the plate circuits as a result of r.f. drops across the supply.

3. Keep grid and plate leads short and well shielded.

4. Bypass tube heaters to ground with perhaps a 100 micromicrofarad condenser.

5. Bypass the output tube plate to ground with a small condenser. Bypass each push-pull plate separately.⁴ A condenser decade box may be useful in determining the optimum capacity, but be on the look-out for possible disturbing effects from the decade unit.

6. Insert a resistor in series with the input tube grid, using a calibrated volume control or a resistance substitution box to determine the best value, which may be around 10,000 ohms. (A resistance decade box may introduce additional noise difficulties.) The grid lead inductance and the grid-to-cathode capacitance may form an LC circuit resonant at or near the interfering frequency. Adding the resistor reduces the "Q" of the circuit.⁵

7. Insert a small, perhaps 2 or 3 millihenry, choke in the grid lead of the input tube at the socket pin. It may be necessary to shield the choke, and in any case, the possible effect of the choke on the frequency response and other performance characteristics should be checked.

8. Try bypassing the input tube grid to ground with a very small condenser, possibly 50 $\mu\text{fd.}$, or try a very high resistance between these points, and check for possible resulting degradation of audio performance.

9. Keep gain controls in "off" position on unused microphone and turntable channels on consoles and other amplifiers. A partially-opened attenuator is an invitation to r.f. pickup when wired to a long pair running out to an empty microphone receptacle in the studio.

Prevention of Rectification

In spite of all precautions, some r.f. may reach the audio equipment. The problem is not only to keep this to a minimum, but also to prevent detection or rectification of this residual r.f. whereby it becomes audible. Following are precautions against some of the most common causes of rectification.

1. Clean all connector and receptacle contacts, especially in low level circuits and make sure mating elements seat firmly.

2. Clean all tube base prongs and their mating socket contacts.

3. Clean grid caps and their connecting clips and make sure their shielding hats make good contact with the tube shell.

4. Tighten all screw-type plugs and connectors.

5. Re-solder all questionable connections, particularly those in low-level circuits.

6. Clean jack contacts by rapidly inserting a plug five or six times, and polish the patch-cord plugs.

7. Check bias on tubes and hold the input signal to the grid below the overload point to prevent nonlinear operation.

Miscellaneous Remedies

1. Try reversing the a.c. line plug at the wall socket.

2. Relocate, re-orient and/or ground any large metal objects in the equipment room or adjacent rooms which may be re-radiating r.f.

3. Use resistive pads instead of transformers for impedance matching, if there is enough gain available to make up for the pad loss. This reduces the number of inductive elements which may serve as r.f. pickup coils. However, the power level should never be allowed to fall below microphone level (approximately minus 60 dbm) since this would degrade the signal-to-noise ratio.

4. Re-locate affected audio equipment which does not respond to other measures. The writer recalls the case of a limiter amplifier in a rack adjacent to a transmitter. The limiter was saturated with r.f. due to extremely difficult field conditions existing and it was necessary to remove the unit to the control room in another building. This was admittedly an unusual situation; ordinarily, properly shielded and grounded audio equipment can be operated in a transmitter room without interference.

5. Turntable equalizers are generally unbalanced and should therefore look into unbalanced preamplifier inputs. Otherwise, r.f. or other stray fields may appear as noise in the preamplifier output. The writer has found this to be one cause of the so-called "contact noise" in attenuator-type volume controls following turntable preamplifiers.

6. Sometimes r.f. noise in a volume (Continued on page 117)

Fig. 2. An r.f. filter for 30-50 ohm microphone lines. For higher impedances, the inductances would be greater and the capacitances smaller. The two coils are wound together in the same direction so that their close-coupled inductances add, thereby blocking r.f. currents which travel in the same direction in both coils. For audio signal currents which travel in opposite directions in the coils, the inductances cancel and offer little attenuation of the signal. The filter should be mounted in a shielded case. Adapted from "Elements of Sound Recording" with the assistance of Dr. Halley Wolfe, the book's co-author. Courtesy of John Wiley and Sons.

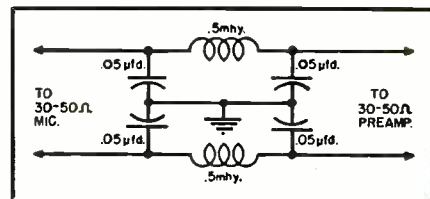

INSTALLING

A COLOR PICTURE TUBE

By

WALTER H. BUCHSBAUM

Television Consultant

RADIO & TELEVISION NEWS



Fig. 1. Slipping a purity coil assembly over the neck of a 15-inch color tube. The yoke and Mumetal picture tube shield are already on the picture tube.

You may not install a color picture tube tomorrow, but you will need to know these facts when you do.

NOW that some manufacturers have started to ship the first color TV receivers to their dealers, information on installation problems is becoming available. The majority of these early TV receivers use the shadow-mask type color tube and this is usually shipped in a separate carton. Assuming that all circuits have been adjusted properly at the factory, the main job is to mount the color picture tube and adjust the various components and controls for proper pictures.

This article presents a detailed setup procedure for both the 15GP22 (RCA) and the 15HP22 (CBS-Hytron), as well as the new 19-inch tubes, based on manufacturers' instructions and the personal experience of the author. It might be mentioned here that a full day was spent for the first setup, but it took less than an hour the third time to produce acceptable color pictures. Installation procedures are presented here in hopes that they will save service technicians from many errors they might commit when they come in contact with color sets.

Before unpacking the picture tube, the color receiver should be air-tested for sound reception. Also check the "B+" and heater voltages. Next, check off the following items which go on the picture tube:

1. Mumetal shield.
2. Deflection yoke.
3. Purity-coil assembly.
4. Convergence-coil assembly and blue magnet for 19-inch tubes.

5. Field-neutralizing coil (omitted in some models).

The major test equipment required is a dot generator or a bar generator. If neither is available, a monochrome or color station signal can be used. For final testing, both monochrome and color signals should be used, although a lot can be accomplished with monochrome only. In addition to a conventional multimeter, a high-voltage probe or meter having a range up to 30 kv. should be available. A mirror will greatly help in some adjustments.

Since the high-voltage supply furnishes up to 27 kv. at 1 ma., the ordinary safety precautions should be increased. Wearing rubber soles and heels, plenty of space to move in, and some privacy, are a great help to the technician in his first encounter with the new color TV monster.

Preliminary Adjustment

Remove the color picture tube from the carton and place it face down on a padded spot. Figs. 1 and 2 show the location of the various items mounted on the 15-inch color picture tube. The Mumetal shield does not fit directly on the tube envelope, but contains foam rubber pads which cushion and center it. A plastic insulating ring, similar to the ones used on metal-envelope tubes, fits over the metal flange which connects internally to the 2nd anode or "ultor." Fig. 3 shows the components on the 19-inch color tube. The major differences between it and the 15-inch

tubes are described in the section on convergence.

After mounting all parts, install the entire assembly on the receiver chassis. The blue gun should be on top, as shown in the socket end view in Fig. 2. Line the inner tube mask up with the cabinet escutcheon. Before connecting power to the receiver, be sure all plugs are in their respective sockets.

Turn the set on, allow for warm-up time, and tune in a monochrome or color telecast. Check fine tuning, contrast, brightness, and sync for best reception. In most color TV receivers, the high voltage is regulated, and this regulation as well as the actual voltage should be checked. The voltage at the kinescope "ultor" terminal—the metal flange near the face of the tube—should remain at 20 kv. (27 kv. for the 19-inch tube), with either a bright or dark raster. Check this by watching the meter and varying the master brightness control.

To improve regulation or increase the voltage to the correct value, adjust the high-voltage regulator control shown in the simplified diagram of Fig. 4. This control is usually located inside the high-voltage compartment.

Next, turn the color or chromaticity control counterclockwise for minimum color video and adjust the contrast or brightness control for a fairly clear picture. At this stage of adjustment, the coloring of the screen can be neglected and adjustments for a.g.c., horizontal and vertical sync, linearity, size, and centering should be made. Do not attempt to oversweep the edges of the internal screen mask, but rather leave the left and the top edge visible.

For these adjustments, especially for linearity checks, a station test pattern is very helpful. If none is available, the bar generator can be used. In color TV it is absolutely essential that both vertical and horizontal linearity be near perfect. Later adjustments will affect such other criteria as focus and convergence. Incorrect linearity will greatly complicate the dynamic focus and convergence adjustments, so be sure to get the proper aspect ratio, size, centering, and linearity before adjusting any of the color controls. Good synchronization, especially in the hori-

RADIO & TELEVISION NEWS

zontal section, is also essential. Most receivers use a modified synchroguide circuit, requiring both locking and phasing adjustments for which standard black-and-white adjustment procedures apply.

The cylinder located near the picture-tube socket, as shown in Fig. 2, is the purity coil assembly. It consists of the purity coil, three small permanent magnet screws, and the magnetic shield cover. See Fig. 3 for the position of the purity coil on the 19-inch tube. Adjusting color purity involves orienting the three electron beams with respect to the center line of the picture tube. It is necessary to vary the location, direction, and magnitude of a transverse magnetic field for each of the three beams and, finally, optimize for best combined operation. One satisfactory method for doing this is outlined below.

1. Remove the video signal and turn down the green and blue screen controls. (See Fig. 5.) Adjust the red screen control for a screen color of almost pure red.

2. Slide the deflection yoke as close to the purity coil as possible, and screw the three permanent magnet screws out from the center for minimum effect. For the 19-inch tube, turn the d.c. convergence controls to minimum.

3. Rotate the purity coil and adjust the current through it until the center of the screen is a deep pure red. Consider only the center and disregard the edges. It is possible to obtain good purity with several combinations of coil current and position; select the one using the least purity-coil current.

4. Slide the deflection yoke forward until the entire screen is a uniform red. Now the neck shadows and color contamination along the edges should be eliminated by proper yoke placement. It may be necessary to touch up the purity-coil adjustment if it is not possible to get a clean red raster with the yoke placement.

5. Turn the red screen down and the blue screen up. If the screen color is not a uniform blue touch up the purity-coil current and rotation slightly.

6. Turn the blue screen down and the green screen up. It may again be necessary to touch up the purity adjustment.

7. Check purity again on red and blue. In some receivers a compromise must be made between best purity on all three colors.

8. It may be that all preceding adjustments cannot be made as smoothly and simply as described. Occasionally some stray magnetic field may interfere and this would be noticeable by sudden rather than gradual variations in purity or by stubborn color contamination at a particular spot on the screen. Such external magnetic fields may be due to a magnetized screwdriver, a permanent magnet speaker, or other magnetic device located near the receiver. Some color sets use a field neutralizing coil located near the screen as shown in Fig. 2, and this coil can be adjusted to overcome the effect of stray

fields. In general, the field neutralizing coil is rotated and the current through it adjusted to aid the purity assembly in its operation. The adjustment procedure described appears quite complex and time consuming, but after some practice it is possible to perform the purity alignment in five minutes.

Convergence Adjustment

In order to get sharp and clear color pictures it is necessary for all three electron beams to strike the screen simultaneously at adjacent dots. For the 15-inch tubes, three separate forces make the beams converge and each of these must be carefully adjusted. The first consists of three small magnets located on the purity coil shield around the neck of the picture tube. Each magnet has its major effect on the electron gun lying underneath it, but also affects the beam from the other two guns. The purpose of the magnets is to position the three beams so that the three colored rasters coincide.

In addition to the magnets there is an internal, electrostatic-lens type element in the 15-inch tube which controls the beam convergence at the screen. It receives a high d.c. voltage, adjustment of which determines the convergence at the center of the screen. The convergence element also receives a horizontal and vertical dynamic convergence voltage which, when superimposed on the d.c. potential, determines the convergence at the edges of the screen. This dynamic convergence signal is required to compensate for the variation in electron beam path length as the beam moves from the center of the screen to the edges. Fig. 6 shows the wave shape of the dynamic convergence voltage.

It should also be pointed out that the beam focus must be varied as well. In

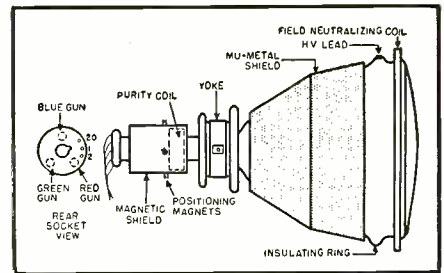

Fig. 2. Shown here are the various focusing and deflection components that mount onto a 15-inch color picture tube. The field neutralizing coil may be omitted in some receivers.

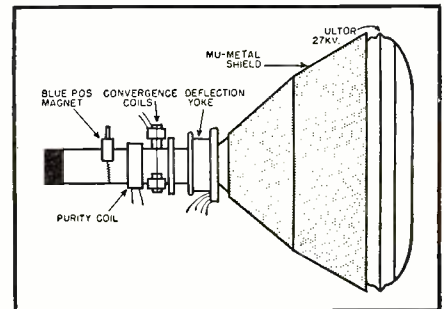
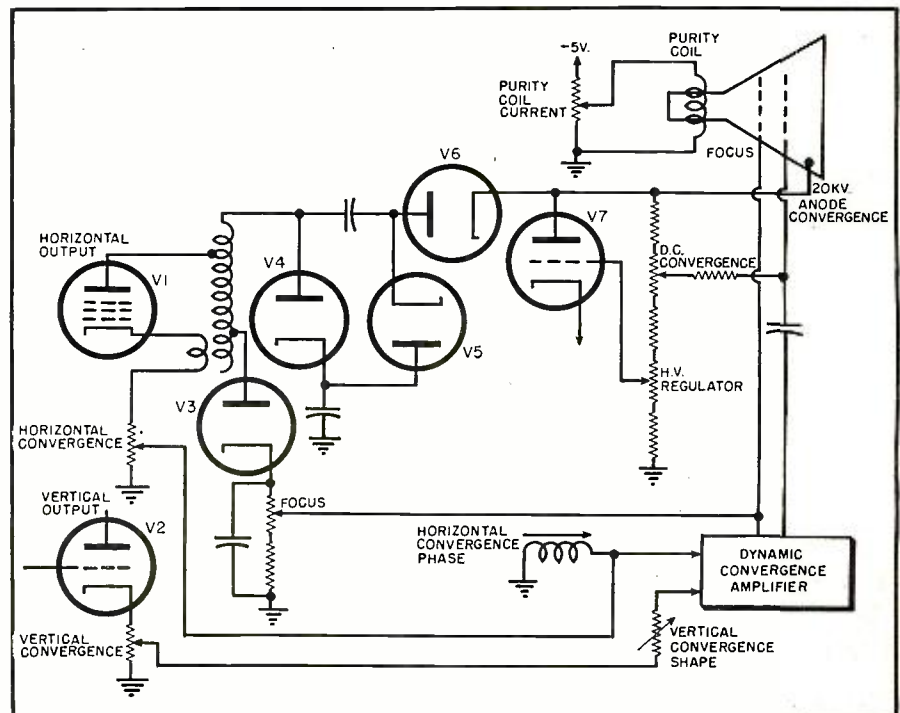

Fig. 3. A 19-inch shadow-mask type color TV tube shown with the various deflection and focus components. Note that here electromagnetic convergence is used rather than electrostatic.

the 15GP22 and 15HP22 there are three electrostatic focus elements connected together which receive a d.c. focus voltage, plus a portion of the dynamic horizontal and vertical convergence signal. The schematic presentation for this connection is shown in Fig. 4.

Before adjusting for convergence and focus, the screen should be tuned for a low-brightness white. This is done by turning the chromaticity control down and adjusting the red, blue, and green

Fig. 4. Focus, high voltage, purity, and convergence adjustments for color set.



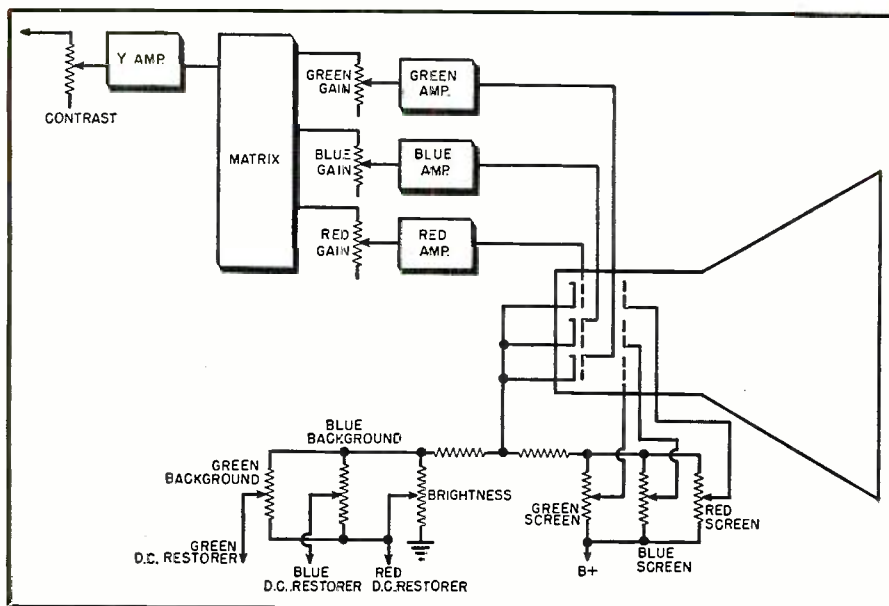

Fig. 5. Brightness, contrast, and color controls of a color TV receiver. Not all of these controls are adjusted by the service technician when he installs the tube.

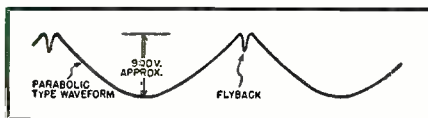

Fig. 6. Wavelshape of the horizontal convergence voltage for a 15-inch tube.

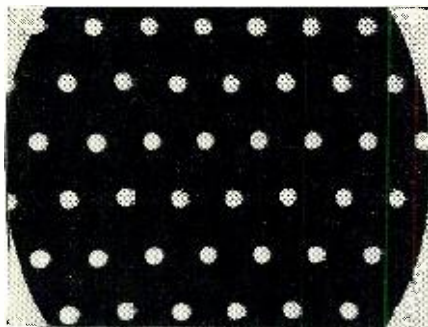
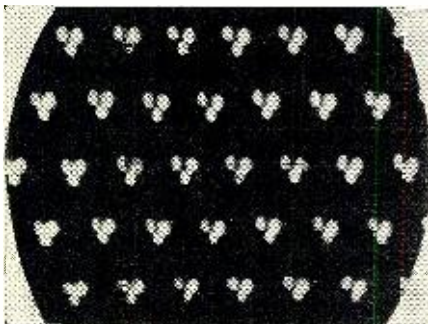

Fig. 7. Dot pattern generated by a dot generator and observed on the screen of a color picture tube when the three guns are in good convergence. Each dot actually consists of three different colored ones, so close they look like one.

screen controls until a neutral white or light gray is obtained. It should be pointed out that this will not be achieved when all three controls are set to exactly the same point. To get white some experimentation is required

Fig. 8. The pattern appearing on the face of a color tube when a dot generator is used and the d.c. convergence voltage is lower than normally required.



which usually provides a demonstration of the principles of colorimetry. When the blue screen is turned down and the red and green turned to about equal brightness, yellow will appear. Red and blue only will result in shades of purple. With some practice it is quite easy to get a neutral light gray quickly.

To set the three positioning magnets roughly, adjust the centering controls until a corner of the raster appears. Usually this corner will show some of the colors even when the rest of the screen is white. It will appear that the three rasters do not overlap completely. Where all three overlap, white will appear. Where red and green overlap the screen will appear yellow. Red and blue give magenta, and blue and green produce cyan (a greenish blue color). At this stage it is best to "make haste slowly."

Turn each of the three permanent magnet screws inward one turn at a time, and observe the effect of each one on all three colors. It will become apparent that each of the magnets has major control over one color but also has considerable effect on the other two electron beams. In other words, the adjustment of each magnet must be followed by adjustment of the other two magnets until a good compromise setting is reached. The aim of this compromise is to get all three colors to coincide as well as possible. It should be pointed out here that perfect corner registry is not essential nor easily attainable.

The convergence adjustments must be made with some kind of video signal, otherwise lack of convergence is not apparent. The best type of signal consists of a number of very sharp pulses, producing a dot pattern on the screen. Other usable patterns consist of vertical and horizontal bars, preferably in a grid pattern, or a regular monochrome video signal. In the last instance it is preferable to use a station test pattern if available.

Poor convergence will give the ap-

pearance of three colored pictures out of register. When the monochrome video signal is used, the edges of objects will appear in three colors, rather than uniform gray. If the d.c. convergence is good, this poor registration effect will be most noticeable at the sides. This is somewhat tricky to check especially on moving scenes. For this reason the use of a grid or dot pattern is better. Adjusting convergence with a dot generator is fairly easy.

1. Connect the dot generator and adjust the brightness and contrast controls to avoid blooming and obtain sharp dots, locked in with the sweep circuits. Fig. 7 shows the screen of a color tube with a properly converged dot pattern.

2. Referring to Fig. 4, turn both vertical and horizontal dynamic convergence controls to minimum.

3. Turn the d.c. convergence voltage control to a low value until three separate dots are visible as in Fig. 8. The green dot is at the left, the red next to it, and the blue below.

4. Turn the d.c. convergence voltage control up until the three colored dots merge into a white dot at the center of the screen. If the convergence voltage is too high the pattern of Fig. 9 will appear where the blue dot is on top and the entire color sequence reversed from Fig 7.

5. It may not be possible to obtain perfect convergence at the center of the screen with the d.c. convergence control. In this event the positioning magnets must be reset. Every change in the positioning magnets will require some further change in the d.c. convergence setting. At the same time the focus control must be set each time for best focus. All these adjustments are interdependent to some degree and the best approach is to perform each step slowly, not advancing any control too far and carefully observing the dot pattern on the screen. In some picture tubes it may appear that the magnets should be positioned quite close to the guns, but this means that the optimum position has already been passed and the magnets should be withdrawn several turns.

6. After the center of the screen shows clear white dots without color fringing, the dynamic convergence controls are adjusted. The vertical dynamic convergence controls, see Fig. 4, are set first to make the top and bottom misregistration equal. Observe the dots going down the center line and when top and bottom dots appear equally misregistered, touch up the d.c. convergence control to converge the entire vertical center line of dots.

7. Now adjust the horizontal dynamic convergence control for equal misregistration of the left and right dots on the horizontal center line. As in step 6, touch up the d.c. convergence control to converge the entire center line.

8. If it appears impossible to converge both left and right edges, the horizontal dynamic phase control, as shown in Fig. 4, should be adjusted. Similarly, if vertical convergence cannot be achieved properly, the vertical

(Continued on page 92)

THE CURVE THAT CONFORMS

EVER since the advent of the long-play record and high-fidelity reproduction, music lovers have been plagued by a thing called "record equalization." No one questioned the merits of equalization but many decried the lack of standardization in the recording industry.

Before the LP era everything was relatively simple. There was one curve (Columbia-NAB) and for six or seven dollars you could buy a neat little preamp with the curve built in and unvariable. Since the advent of LP discs, however, it seems that every engineer in every record company has a different idea about record equalization. Before you could say "turnover," music lovers were overwhelmed by such curves as NAB, AES, *ffrr*, *Orthophonic*, and others. The preamp? It has become a bloated monster, replete with many knobs and dials for the production of the widely varying curves. Needless to say, the price of participation in this exotic and fascinating game of "match the curve" has gone up too, from six to fifty dollars and more.

After several futile attempts at standardizing the equalization curve, most manufacturers gave up and continued the *status quo*. At this point the powerful and influential Record Industry Association of America (RIAA) entered the fray, and now, happily, it is possible to report that the new "RIAA Standard Record-Playback Curve" is

Record manufacturers have now agreed not to disagree with the new record-playback curve. Here are the details.

being adopted throughout the record industry.

Essentially, the new RIAA curve is the same as the RCA Victor "New Orthophonic." The bass turnover point is 500 cycles, the same as the old NAB, but with a 3 db flattening at 50 cycles. Treble roll-off is 13.75 db at 10,000 cycles. It is interesting to note that the old AES curve falls within ± 2 db of the new curve above 40 cycles.

Now, what does all this mean to you, the record consumer?

First, you will want to know what companies have agreed to standardize on this one curve. The answer is, virtually everyone. A little later on in this article we will give you the comments of responsible people at most of the major companies regarding the adoption of the new curve. The next thing you will undoubtedly want to know is how this new curve will affect your playing equipment. Is your expensive preamp now obsolete? The answer is a qualified "no." While very few preamps have the RIAA curve incorporated in its circuitry, most have the AES curve which, as noted previously, is within the tolerance limits of the new curve above 40 cycles.

If you are trying to duplicate the

RIAA curve on a unit with provision for NAB and AES curves, set the bass turnover on the NAB curve, treble equalization set at AES and cut the bass and treble tone controls slightly. If you have a one-knob equalization control on your unit, set it at either the AES curve, in which case you cut the treble and boost the bass a little (on your tone controls) or NAB curve in which you boost the treble and cut the bass slightly on the tone controls. Of course, if your unit has the RCA "Ortho" curve, you are all set, since it is identical with the new RIAA curve.

In all this adjusting for equalization remember this, your acoustic environment is an important factor. Use your tone controls to make the music sound right to *your ears*. That is what tone controls are for. You may have a "hard" room with many reflecting surfaces in which you'll probably want to cut your treble somewhat. Then again, you may have the reverse situation with many absorptive bodies like drapes, rugs, and upholstered furniture, which might call for some bass and treble boost.

Still another factor in this business
(Continued on page 78)

New RIAA recording and playback characteristics. The triode and pentode amplifier equalizer circuits (Figs. A and B respectively) when used with a high quality amplifier and pickup are recommended by RCA to obtain the desired basic reproducing characteristics. Minor tone-control adjustments may be required to compensate for pickup characteristics.

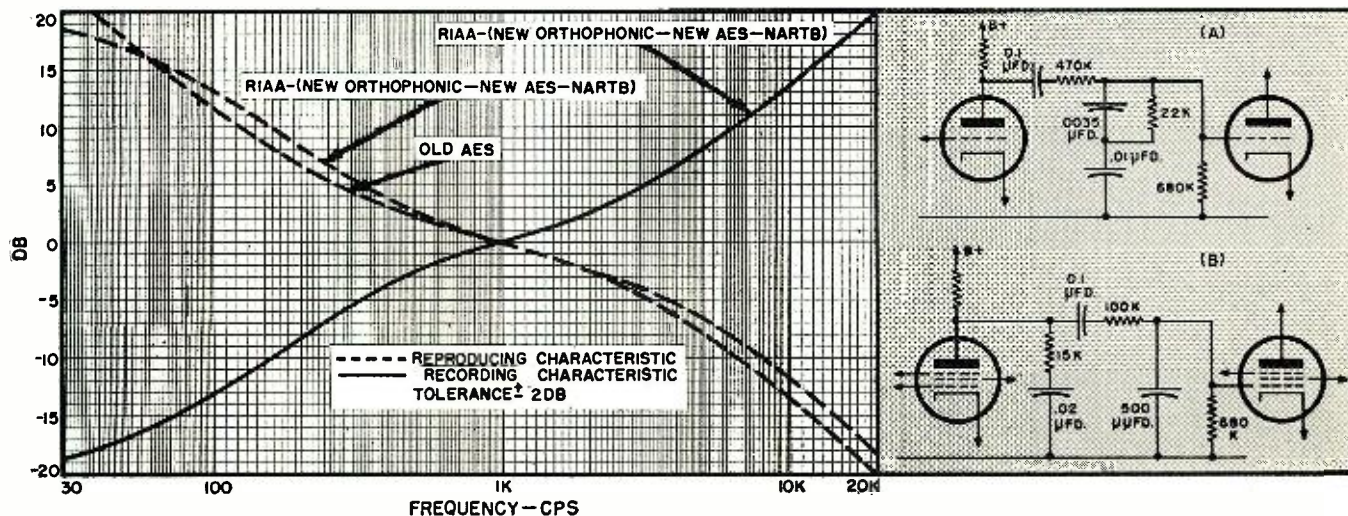

A Profitable Sideline—

P.A. RENTALS

By OLIVER BERLINER

Branch out for year-round income. Public address work offers new opportunities for both sales and service.

THE radio-television service shop interested in a money-making sideline should give some thought to public-address system rentals. These could easily grow into a worthwhile venture which could lead to permanent installations and equipment sales. Here is how to go about getting started in this lucrative field.

The first thing to do is analyze the needs of the community and the extent of your competition. The latter point you will have to determine for yourself but the potential market can be discussed here.

A great deal of all sound rental service work is performed evenings and weekends. For example, there are school and club dances, public dances, private parties, banquets, meetings, sporting events, stage attractions, ground breakings, civic events, etc.—all of which are elements of the vast potential in this field.

To a certain extent, the type of work you do will determine the type of equipment you will use so for this reason alone it is essential that you analyze the activities and needs of your potential customers.

Equipment and Systems

Although every technician knows that an amplifier is, essentially, simpler than a television set or a radio and that he will probably have no difficulty in repairing one, unfortunately the average technician's knowledge drops off abruptly at this point. Do not think that because one is an expert in television repairs, he is equally capable of designing, installing, and operating a sound system. Public address work is an art in itself and requires a great deal of trial and error, knowledge of room noise levels and acoustics, and a knowledge of equipment features and limitations before one is able to do satisfactory work at the right price and with a minimum of equipment, effort, and time.

Devote some time to studying manu-

facturers' catalogues as a great deal of knowledge can thus be obtained at no cost and little effort. For example, *University Loudspeakers* publishes "Technilog" and *Masco* offers its "Sound Surveyer"—both of which provide invaluable information on loudspeaker characteristics and usage. Similarly, other manufacturers of sound equipment have handy tables, pamphlets, and manuals available at nominal or no cost.

In order to keep the amount of equipment at a minimum, a proper selection of components, determined by the needs of the community, must be made. Two principal types of jobs present themselves—one in which the customer merely rents the equipment and operates it himself and the other in which you install and operate the equipment.

You should be prepared to allow the customer to operate some of the equipment himself for many affairs do not warrant the services and expense of a paid operator. Under these circumstances the customer should be prepared to come and pick up the equipment, receive brief instructions on how to set it up and operate it, and bring it back at the required time.

A number of manufacturers make this type of portable outfit and you should select one capable of handling from 15 to 30 watts of normal audio power output. Perhaps an outfit incorporating a record player would be desirable. At first buy just one of these outfits, adding more units as business expands. One or two microphones with a floor stand for each should be included in the system. The rental can be upped in cases where the customer requires two microphones instead of one.

A portable sound system having two 12-inch PM speakers should be used. The speakers should be self-supporting and also be capable of being hung on a wall. The microphone connectors should be so different from the loud-

speaker plugs that their hookup becomes obvious to the layman and no mixup can occur. All controls and connectors on the amplifier should be properly labeled.

The list of suggested components comprising a small, basic public address system rental outfit is given in Table 1. This outfit will provide two complete sound systems. If all the equipment is combined into a single installation you would be able to feed six loudspeakers with 45 to 60 watts of power, using three microphones and two record players, all separately controlled.

Let us examine the characteristics of the components more closely. The author has used virtually every principal brand of microphone with every high quality feature and has found that for price, ruggedness, compactness, reliability, feedback reduction, output level, good looks, and ease of operation, the straight pressure (dynamic) microphone can't be beat. An important feature of this type of unit is that it takes the breathing and banging of the layman and is foolproof in use. The author recently attended a gigantic stage show in Hollywood where a group of top movie stars appeared. The show was almost ruined by the fact that these professionals were speaking into the wrong part of a new type microphone recently released by a major manufacturer.

The high impedance microphone system is often lower in price than its low impedance equivalent, principally because no input transformer is required. The limitation, of course, is that cable lengths in excess of 20 to 25 feet will result in drastic reduction of high-frequency response. Although the beginner may wish to start out with a high-impedance unit, he will soon find, as business increases and installations become larger and more complicated, that he will have to convert to low impedance microphones—a change that will cost between \$8 and \$15 per microphone, not counting the cost of changing to low impedance cables, input transformers, connectors, and the corresponding "down time" of the equipment. Try the *Electro-Voice* 630 or *Turner* 22D microphone.

The portable sound system needs are described in Table 1. Look over the features of units like the *Newcomb* TR-25AM.

The three-section microphone floor stand specified is useful as a banquet table stand and also where a microphone must be placed close to the floor. It of course functions as a regular floor stand when required. The boom attachment is excellent where the stand has to be a few feet from the performer, but where the microphone must be very close to him. The *Atlas* BB-1 or similar units meet this requirement inexpensively.

For the regular p.a. work that you will do involving one or two microphones, you will want to use a 25 to 30 watt basic amplifier with preamplifiers. Any one of the principal brands will

probably do nicely. The input impedances must match those of the microphones. You may wish to build your own amplifier but before doing so carefully determine the parts and labor cost. You may find that you are better off purchasing completed amplifiers.

The choice of a loudspeaker is probably more important than that of a microphone. You will probably need at least one set of outdoor horns. These particular units should be, at least, semi-weatherproof. Such horns are needed in order to make up for the immense amount of power lost in the open air. The new CDP speaker by *Electro-Voice* is well suited for this work as it is weatherproof, has good frequency response, good dispersion angle, and will handle a lot of power. This same speaker can be used indoors for long throws or noisy areas.

For normal indoor work, and sometimes outdoor applications, a cone speaker gives the best quality service. Unfortunately, a large baffle is often required, however both *Altec* and *Stephens* offer excellent compact portable cabinets which give rather good results. *RCA* offers its MI-12448 series floor cabinet which is light weight and can be moved around fairly easily. A bracket should be fastened to your portable, full-range speaker cabinet so that it may be attached to a collapsible speaker floor stand when it is necessary to raise the speaker above the heads of the crowd.

Most cone-type public address loudspeakers are of 8 ohms impedance as contrasted to the usual 15 ohms of horns. This is unfortunate for only two speakers can be driven from the 4 ohm output tap on the amplifier. If the speakers were 15 ohm units you could connect four of them to the 4 ohm tap without the need of matching transformers. A higher impedance is also advisable so that the resistance of the cable will not introduce noticeable power attenuation.

The microphone and loudspeaker cables should be equipped with the type of connectors which will allow the cable to be connected to the amplifier or used as an extension. If not, you will be plagued with the constant need for resorting to wasteful adapters.

Headphones are handy for monitoring installations where the operator cannot easily hear the loudspeakers. A jack and volume control can usually be mounted on the amplifier with the control bridged across the 500 ohm or 70 volt output tap to ground. A volume indicator meter is also handy and is sometimes a necessity.

As mentioned previously, it is often necessary to utilize matching transformers when connecting large numbers of speakers to an amplifier. Basically, these transformers merely connect to one of the higher impedance taps on the amplifier output transformer and convert it to the impedance of the speaker. A separate transformer is required for each loudspeaker, with the combined primary impedances of all the transformers in parallel equal

to that of the amplifier output tap to be used. The matching transformers should be located near their respective speakers so that the longer cables are in the higher impedance part of the transmission line. Equip your matching transformers with the proper input and output connectors and impedance selector switch so that they may be put into service as required without hurried calculations and connections.

A tape recorder is a handy "accessory." On many occasions you will be called upon to provide sound reinforcement and simultaneously record the proceedings. The recorder should be capable of recording directly from a microphone as well as taking a "feed" from the p.a. amplifier. Although the recorder could be connected to the headphone outlet built into the amplifier, it is best to connect it to one of the first audio stages so as to keep hum and distortion on the recording to a minimum.

Standardization

In order to insure complete and instantaneous interchangeability and intermixing of equipment, it is important that connectors be standardized. This means that if the various amplifiers have different microphone connectors you will have to replace some of them, otherwise a large array of adapters will be required. This also applies to phonograph and loudspeaker connectors.

On applications requiring large amounts of audio power it may be necessary to parallel the inputs (and sometimes the outputs) of two or more amplifiers. In most cases a high impedance jumper or "patch cord" between the first audio stages will do nicely. Then, a single set of input gain controls on one of the amplifiers will control everything as though only one amplifier is in use.

What About Prices?

A careful study of your competition will undoubtedly reveal a little about your competitors' prices and pricing methods. This should not be too difficult on rentals but may pose a problem

on permanent installation sales as many cost and bidding formulas prevail and list prices are often disregarded.

A new entrant into the field will probably have to keep his prices relatively low until customer confidence and acceptance permit a reasonable profit to be realized. An interesting facet of the sound rental business is that once you have a satisfied customer you won't have much trouble keeping him, for service is as important as price in this business. Newspaper or mail advertising as contrasted with recommendations of satisfied customers, will not be too helpful. An ad in the "classified" telephone directory and personal calls on prospective customers will be your next best bets.

Tricks of the Trade

After you have provided equipment for several p.a. rentals, a number of helpful ideas will occur to you. Certain accessories, such as separate loudspeaker "T" pads, low-level monitor amplifier/speakers, broadcast-type mixer/line amplifiers, bridging and distribution transformers, etc., will find their way into your equipment line-up. You may wish to outfit a truck with sound equipment, allowing all operations to be from the truck when possible. You may wish to go in for mobile operations to ballyhoo conventions, political candidates, etc., or specialize in battery-operated equipment for picnics, sports events, etc.

Many permanent installations are actually rentals, that is, the equipment is permanently installed where the customer desires it and most of it is never removed. The customer pays so much a year or a season for you to supply, operate, and maintain the equipment. If you are planning a long-run sound operation, this type of business is worth your consideration as the customer benefits by paying relatively small amounts for current usage while you actually have made a sale which is virtually impossible to lose. This is also helpful to you incometaxwise as it allows you to spread your income over a

(Continued on page 88)

Table 1. Suggested components for a small basic p.a. system rental outfit.

QUANTITY	DESCRIPTION	
3	Pressure microphones, unidirectional, 250 ohm impedance	with a collapsible floor stand for each, 15 ohms impedance
1	Portable sound system; 15-30 watt amplifier with phono turntable, two 12-inch loudspeakers with 25 ft. cables, two low-impedance microphones and one high-impedance phonograph separately controlled inputs, tone control, pilot light	2 Bass reflex type loudspeakers/cabinets, 20 watts, light weight, 15 or 8 ohms impedance
2	Microphone floor stands, two-section, heavy base	2 50 ft. detachable loudspeaker cables, No. 16 or No. 18 wire with connectors
1	Microphone floor stand, three-section	2 100 ft. detachable loudspeaker cables, No. 16 or No. 18 wire with connectors
1	Microphone boom attachment	2 100 ft. No. 16 or No. 18 a.c. power extension cords
3	50 ft. microphone extension cables with connectors	1 Record changer attachment, three-speed, crystal cartridge
1	25-30 watt amplifier with two 250 ohm microphone inputs and one high-impedance phono input, tone control, pilot light	1 Pair high-impedance headphones
2	Re-entrant trumpet-type loudspeakers	1 Set of loudspeaker matching transformers
		2 Special "multiple" cables to allow speaker wires to be extended from loudspeaker to loudspeaker in order to eliminate doubling up of cables
		1 Tape recorder

A BASS-BOOST CONTROL

By ALLAN M. FERRES

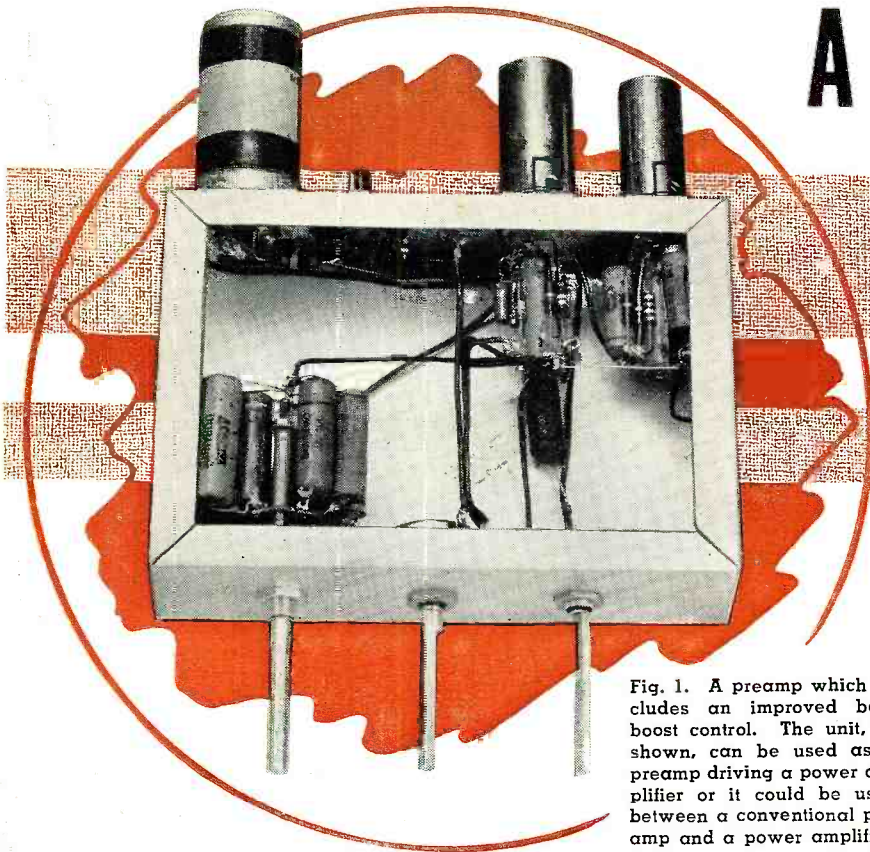

Fig. 1. A preamp which includes an improved bass boost control. The unit, as shown, can be used as a preamp driving a power amplifier or it could be used between a conventional preamp and a power amplifier.

Details on a separate control unit designed to provide a maximum of ten transition frequencies.

TOO many bass-boost controls muffle music and speech. It is a simple matter to change such a control to a better one, or to build a new amplifier using an improved circuit.

The trouble with the usual control is easily explained. Fig. 2 shows the conventional bass-boost circuit and its response curves. The frequency at which the response is increased 3 db is called the "transition frequency" and is that frequency at which the reactance of the condenser is equal to R_2 . As neither the condenser nor R_2 is adjustable, this frequency remains constant.

The total boost available depends upon the value of R_1 , R_2 , and R_3 . As E_1

is the only adjustable element, then a flattening or "shelving" of the response curve occurs when the bass-boost control (R_1) is set at less than its maximum-boost position. (Shelving also occurs at very low frequencies at maximum boost, but this need not be considered here.) Curve A shows the response at full boost, and curve B shows how the curve flattens out at about one-half boost.

This circuit is widely used due to its simplicity, but has two drawbacks which should be given consideration.

The first is that at moderate listening levels, at which, let us say, 8 db of boost at 100 cycles sounds about right, 3.5 db of boost is also obtained at 600

cycles, as shown in curve B. This tends to make a speaking voice sound muffled and upsets the tonal structure of the music produced by instruments whose fundamental tones lie in the mid-frequency region. This causes the type of sound referred to as "muddy" or "indistinct" by laymen.

The second objection is this. Of necessity, the bass-boost control is used in most systems to compensate for a falling-off of the over-all low-frequency response due to deficiencies of the speaker, baffle, or room acoustics. As these deficiencies usually exist at fairly low frequencies only, the boost produced at the mid-frequencies by the conventional control tends to emphasize speaker, baffle, and room resonances and make the system sound much less satisfactory than it should.

A more satisfactory control would be one which provided a continually-variable transition frequency. With such a control, the extreme low frequencies could be boosted as desired without disturbing the flatness of the response curve in the mid-frequency region.

The control and associated amplifier to be described here does not provide a means of compensation for all low-frequency-response troubles, but it does go a long way toward providing a better control of the bass response of a home radio/phonograph system. This control and amplifier was designed to provide a wide choice of transition frequencies as simply as possible.

As it has been found in practice that a choice of seven or eight transition frequencies is as satisfactory as a continually variable frequency, and as it results in certain circuit simplifications, a tap-switch type of control is used. In this case, a choice of ten frequencies is provided, but the number can be reduced if desired.

As mentioned previously, the transition frequency depends upon the values of the condenser and resistor, R_2 , of Fig. 2. Varying either one would shift the frequency. In the improved control, the condenser is varied. At first glance, it would seem easier to

Fig. 2. A conventional control circuit and the resultant response curves. See text.

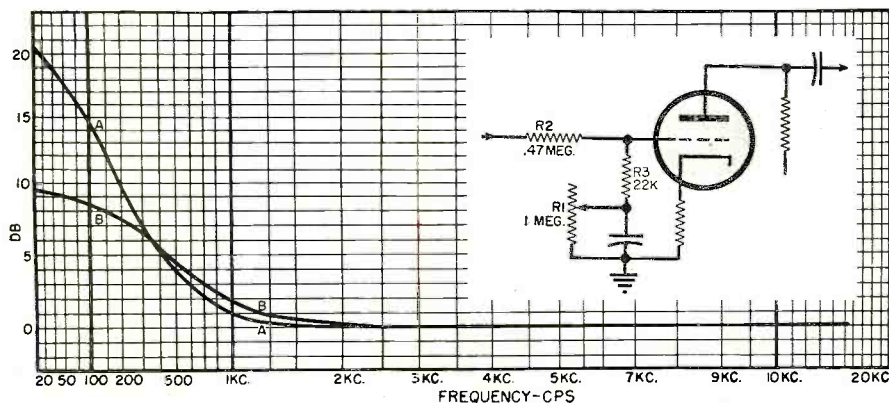

vary R_2 , but as the amount of boost is also dependent upon R_2 , and as there is a fairly limited range over which R_2 can be varied, the capacity variation is the better method.

The chart, Table 1, lists the condensers and the corresponding transition frequencies used by the author. If the reader wishes to experiment with other transition frequencies, the proper value of capacity in microfarads can be found by dividing 7.25 by the frequency desired. Similarly, with a given condenser, the resultant transition frequency in cycles is equal to 7.25 divided by the capacity of the condenser, in microfarads.

The transition frequency is that at which the reactance of the condenser equals R_2 . The reactance of the condenser, X_c , equals $1/2\pi fC$, where f is in cycles and C is in farads. Transposing, C equals $1/2\pi X_c$. Substituting 22,000 ohms for X_c , and multiplying by 10^6 , C equals $100/13.8f$. Solving the equation produces C equal to $7.25/f$.

Similarly, the frequency in cycles equals $7.25/C$, C being in microfarads.

It should be noted that ordinary paper condensers can be expected to be as much as 20% off from their rated value. This will affect the response curves obtained in the completed amplifier, as will be seen from the curves of Fig. 4. However, it has been found satisfactory to select condensers from the chart or by formula. The reason is that the exact frequency itself is not too important as long as there is a wide enough choice of frequencies available. After the amplifier is completed and tests indicate that one or two curves need correction, then a change can be made in the responsible condenser. If the transition frequency is too low, a condenser of lower capacity is substituted and if too high, a larger condenser can be used.

R_2 should be selected by testing with an accurate ohmmeter to be sure that it is as close as possible to 22,000 ohms. If it is not close to this value, all of the transition frequencies will be off even though the condensers used are accurate. The regular commercial tolerances are satisfactory for the other resistors and condensers in the circuit as they have little effect upon the over-all frequency response.

In order to provide an adjustable treble boost, R_1 and C_{11} are included in the circuit of Fig. 3 and a 500,000-ohm pct is used for R_2 . When the arm of R_2 is rotated to the end of the pot that is connected to R_2 and R_1 , its counterclockwise position, C_{11} is effectively out of the circuit. This is the setting for flat high-frequency response. When the arm is rotated to the end connected to R_1 , the higher frequencies are bypassed around the attenuating network R_2 and R_3 and fed directly to the grid of the tube. This produces the maximum treble boost. As shown in the curves of Fig. 4, the high transition frequency is about 3000 cycles at full treble boost. This transition frequency can be

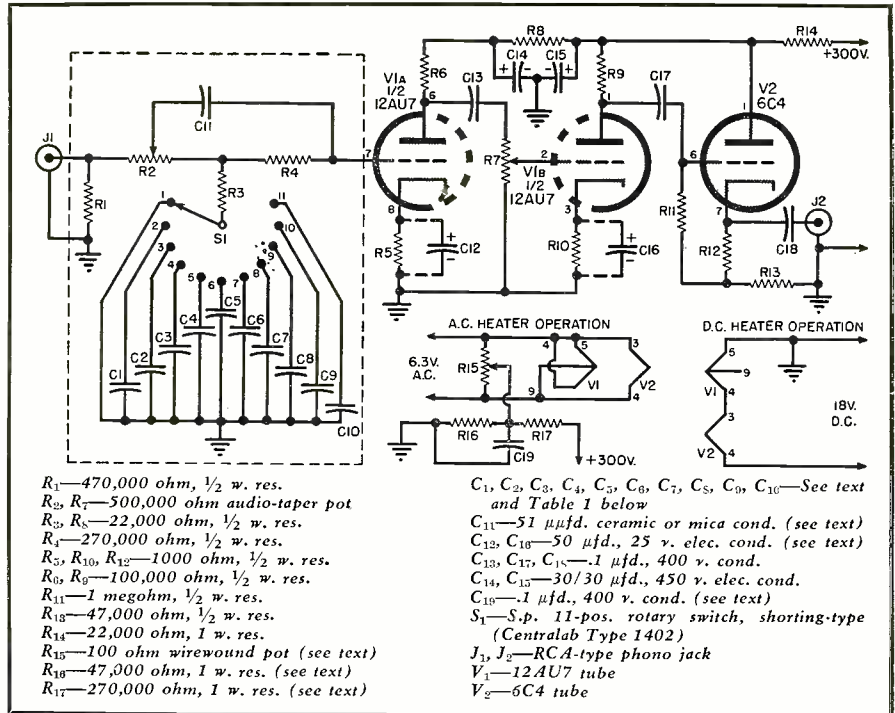

Fig. 3. Schematic of control and amplifier. Section in dotted portion can be added to an existing amplifier, if desired, or built in conjunction with amplifier diagrammed.

raised, if desired, by using a smaller condenser in place of the 51 μ fd. specified for C_{11} , or lowered by using a larger value.

In order to provide a good signal-to-noise ratio with a minimum of distortion, the tone control circuits are connected to the grid of the first tube of the amplifier and the gain control is placed between the first and second stages. As the input impedance of the amplifier is not less than about 150,000 ohms at any frequency, irrespective of the tone control settings, it may be fed from either a triode amplifier or cathode-follower stage of a tuner or phono preamp.

The input signal level should not be greater than about 1 volt. If the tuner or phono preamp used furnishes an output greater than this, a gain control should be used on the input source to reduce its output to the proper value. For minimum distortion, the input level should not be greater than necessary to provide sufficient output to drive the power amplifier used in

SW. POS.	CAPACITY (μ fd.)	TRANSITION FREQ.
1	Short	Flat
2	.2	36
3	.15	48
4	.1	73
5	.068	106
6	.05	145
7	.035*	207
8	.022	330
9	.018	400
10	.015	480
11	.01	725

* .035 μ fd. made up of .03 μ fd. and .005 μ fd. in parallel.

Table 1. Values of C_1 through C_{10} and the resultant transition frequencies. The switch positions correspond to those shown in Fig. 3 and the resulting curves shown in Fig. 4.

the system to full volume. As the over-all gain of this amplifier is about 12 db, a 1-volt input will furnish 4 volts output.

The use of a cathode follower in the output stage provides an output impedance of about 650 ohms so that a hundred feet or so of shielded cable can be connected between this amplifier and the power amplifier of the

(Continued on page 88)

Fig. 4. The response curves of the improved bass-boost control. See Table 1.

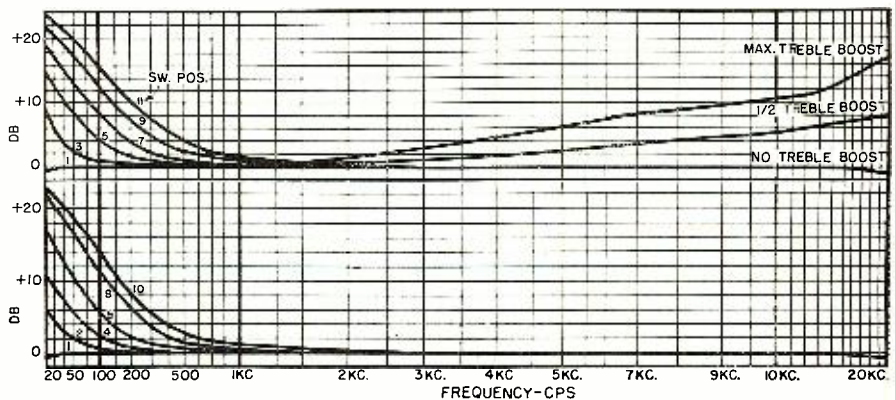

1954 TV RECEIVER SPECIFICATIONS

Continuation of the list of mechanical and electrical specifications on new TV sets for service technicians. See next issue for additional listings.

MFR.	CHASSIS	TUBES							VIDEO I.F. FREQ. (MC.)	H.V. ⁴ (KV.)	U.H.F. PRO-VISION	POWER (WATTS)	SPECIAL FEAT-URES						
		TUNER	I.F. ¹	VIDEO ²	AUDIO	SWEEP ³	P.S.	CRT											
RCA	KCS78	6BQ7	6CB6	6CL6	6AL5	6EQ6GT, 6K6GT	1B3GT	17CP4	45.75	15	11	215	5						
		6X8	6CF6	12AU7	6AU6	6SN7GT, 6SN7GT	SU4G	17QP4											
			6CF6		6AU6	6W4GT, 12AU7	5Y3GT												
	KCS83	6EQ7	6CB6	6X3*	6AL5	6AX4GT, 6EQ6GT	1B3GT	21AP4	45.75	18	11	215	5, 10						
		6X8	6CF6	12AU7	6AU6	6K6GT, 6SN7GT	SU4G	21EP4A											
			6CF6	12AU7*	6AU6	6SN7GT, 6X3*	5Y3GT	21ZP4A											
	KCS84	6EQ7	6CB6	6X3*	6AL5	6AU4GT, 6CD6G	1B3GT	24CP4A	45.75	18	11	245	5, 8, 10						
		6X8	6CF6	12AU7	6AU6	6K6GT, 6SN7GT	SU4G												
			6CF6	12AU7*	6AU6	6SN7GT, 6X3*	5Y3GT												
RADIO CRAFTSMEN	C210P & C210V	6EQ7A 6J6	6CB6 6CB6 6CB6	6AL5 6AU6 6CL6 6CL6	6AL5 6AU6 6AU6 12AU7	6AL5, 6CB6 6CD6, 6S4 6SN7, 6SN7 6W4, 12AT7 12AU7	1B3 SU4G 5Y3	24CP4A 27EP4 27RP4	42	18	Strips or 11	365	Designed for cus- tom in- stalla- tions						
	21T2	6BZ7 6U8	6CB6 6CB6 6CB6 6CB6	CK706 25C5	6AL5 6AU6 6AV6 25C5	6AL5, 6BE6 6S4, 12AU7 12AU7	1B3 6AX4 25BQ6	21YP4						41	18	11	175	2, 3	
	21T11	6BZ7 12AT7	6CB6 6CB6 6CB6	6AL5 25C5	6AL5 6AU6 6AV6 25C5	6AL5, 6BE6 6S4, 12AU7 12AU7	1B3 6AX4 25BQ6	21YP4											20
	24T2	6BZ7 6U8	6CB6 6CB6 6CB6 6CB6	6AH6V 6AU6 CK706	6AL5 6AU6 6AV6 50C5	6AL5, 6BE6 6BF6, 6BF6 6S4, 12AU7	1B3 5Y3 12AX4 25CD6	24DP4						41	18	11	265	2, 3	
24T3	6BQ7A 12AT7	6CB6 6CB6 6CB6	6AH6V 6AL5 6AU6	6AL5 6AU6 6AV6 50C5	6AL5, 6AV6 6BE6, 6BF6 6S4, 12AU7	1B3 5Y3 12AX4 25CD6	24DP4	20	18		265	2, 3							
SENTINEL	X19	6BQ7A or 6BZ7 6J6	6CB6 6CB6 6CB6	1N30 6CL6	6AL5 6AU6 6SN7*	6BQ6, 6SN7* 6SN7, 6SN7 6W4, 12BH7	1B3 SU4						17HP4A 21FP4A 21YP4A	45.75	15	11 or Strips	225	5, 10	
		X21	6BQ7A or 6BZ7 6J6	6CB6 6CB6 6CB6	1N30 6CL6	6AL5 6AU6 6SN7*	6BL7, 6CD6 6SN7, 6SN7 6SN7*, 6V3 6V3, 12BH7	1B3 SU4 SU4	24CP4A 24TP4A 27EP4	45.75	18	Strips	250						10

1. Video i.f. tubes only. 2. Includes detector and a.g.c. 3. Includes sync section and a.f.c. 4. CRT 2nd anode voltage. 5. Removable safety glass. 6. Local-fringe a.g.c. adjustment. 7. High-fidelity sound. 8. Aluminized picture tube. 9. TV-radio-phono combination. 10. Built-in antenna. 11. 82-channel tuner. 12. Adjustable dial light. *Part of tube is used in another section.

Fig. 1. The appearance of unmodulated r.f. interference as caused by oscillator radiation.

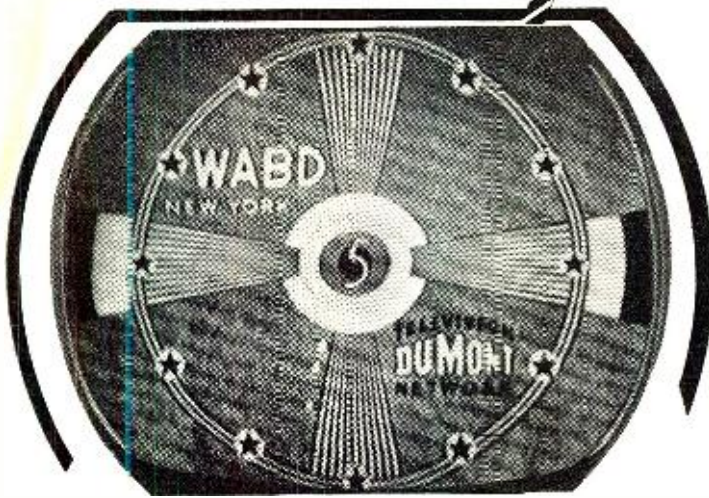

TVI

TROUBLESHOOTING

By **CARL J. QUIRK**
 Allen B. DuMont Laboratories
 Author, "A Handbook of Television Interference"

In the first two articles of this series, we laid the groundwork for successful interference investigations. In this article, we will discuss specific interferences, their causes and suggested cures.

Fig. 1 illustrates interference belonging to the unmodulated classification. Further, adjusting the fine-tuning control could indicate whether this interference was tunable or untunable. Let us direct our attention to cases of the untunable-unmodulated type first.

Oscillator radiation. Of the many sources of unmodulated-untunable interferences, without a doubt the most prevalent source is that of oscillator radiation into other TV sets. This problem is caused primarily by TV sets using an i.f. in the 21-mc. range. The oscillator of the offending receiver radiates a signal whose frequency is approximately 21 mc. plus the frequency of the sound carrier of the received signal. The radiated signal thus falls into a higher channel. The intensity of the interference will, of course, depend upon the radiated signal strength and beat frequency. The closer the interfering signal is to the video carrier of the interfered-with signal, the greater will be its effect. Table 1 shows the possibilities of this interference.

Interference due to oscillator 2nd harmonic radiation will occur primarily in locations where the sets are close together or connected together in some manner; for example, in a dealer's store, or in an apartment house where the sets are back-to-back with only the wall of the adjoining apartment separating the two receivers. In such cases, if a master distribution system is in use, it is not enough that the sets be isolated electrically through the use of suitable isolation pads. It is also important that there be adequate physical separation. This is essential since a great deal of the radiation takes place from the chassis proper.

This type of interference is one of the most difficult to eliminate successfully. One of the reasons and, without

Part 3. Methods of eliminating TVI due to local oscillator radiation and video i.f. harmonics.

a doubt the most important one, is that the interference occurs "on-channel;" i.e., it enters the gate through which the desired signal enters. Any attempts to eliminate the interference by traps at the front end of the set usually will have a noticeable effect on the picture.

The author was successful in eliminating this interference in one particular case by the use of a series-tuned trap to ground in the last i.f. stage, as shown in Fig. 2. To eliminate the interference, which incidentally occurred on channel 13, the trap was tuned into the passband until the interference disappeared. Since this cut a "slot" into the i.f. passband, it might be suspected that the effect would be quite noticeable in the picture. This was not the case though, and the picture seemed unaffected. However, if the set was tuned to another station which had a test pattern on, the notch was plainly visible in the vertical wedge of the test pattern due to the absence of modulation for the width of approximately 500 kc. Unfortunately, such a cure has definite disadvantages, one of which is evident when the owner of the offending set changes the tuning and thus pulls the interference out of the trap.

This particular type of cure will work best when the offending set is

not of the intercarrier type. In such a case, the point of tuning is fixed and, except for oscillator drift, the interference should stay in the trap.

At present, most manufacturers are using an i.f. of 41.25 mc. for sound and 45.75 mc. for video. Since the oscillator frequencies used for this i.f. do not fall into any channel, the problem of oscillator interference is minimized. There is, however, a possibility that harmonics of the oscillator, when operating on certain low channels, will fall into certain high channels. For example, for channel 2, the oscillator signal is 101 mc. Its second harmonic of 202 mc. may interfere with the video carrier of channel 11 (199.25 mc.) to produce a beat of 2.75 mc.

There are several things which can be done to minimize oscillator radiation interference:

(Continued on page 102)

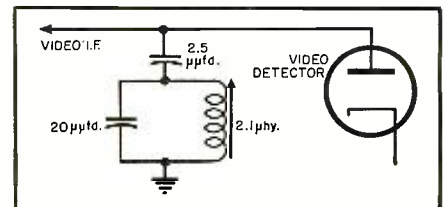

Fig. 2. Trap used in the output of the video i.f. strip to eliminate i.f. due to an interfering oscillator signal.

Table 1. List of the possibilities of interference due to oscillator radiation. The local oscillator of one receiver radiates a signal which mixes with the video carrier of the television signal of another receiver set to a higher channel producing a beat frequency which appears on the CRT as vertical or slant lines or bars.

OFFENDING SET TUNED TO			OFFENDED SET TUNED TO		BEAT
Channel	Video Carrier	Local Oscillator	Channel	Video Carrier	
2	55.25 mc.	81 mc.	5	77.25 mc.	3.75 mc.
3	61.25 mc.	87 mc.	6	83.25 mc.	3.75 mc.
4	67.25 mc.	93 mc.			
5	77.25 mc.	103 mc.			
6	83.25 mc.	109 mc.			
7	175.25 mc.	201 mc.	11	199.25 mc.	1.75 mc.
8	181.25 mc.	207 mc.	12	205.25 mc.	1.75 mc.
9	187.25 mc.	213 mc.	13	211.25 mc.	1.75 mc.



By

DAVID FIDELMAN

Author, "Guide to Audio Reproduction"

How to repair audio systems and check newly constructed audio components by using standard service techniques.

THE high-fidelity reproduction of sound is rapidly becoming one of the major fields of electronics. At one time, those interested in this field were a relatively small group of technicians and engineers who built most of their own equipment, and those high-fidelity enthusiasts who could afford to own custom built equipment. Most of the service and construction was done by technicians who specialized in the setup and installation of custom audio systems.

At the present time, however, the general public has become interested in high-fidelity reproduction and the major radio manufacturers are beginning to produce large quantities of high-fidelity audio equipment for general sale to the public. With the increasing sales of such equipment, there is an increasing amount of service and system setup by the radio and TV service technician who is not an audio specialist.

However, some of the techniques required in the service, construction, and installation of audio equipment are different from those used in standard radio and television servicing. It will be necessary for the service technician to become familiar with these new techniques and to learn how to apply those he is already using.

The basic setup for any type of audio measurement is shown in Fig. 1. A known input signal is applied to the input of the system and the resulting output is measured across the load impedance. Each different unit requires the correct type of input signal and the output must be measured by the proper type of measuring instrument. In audio systems, the various quantities which it may at times be necessary to measure are: (a) audio-frequency electrical signals; (b) characteristics of recordings such as

discs and magnetic tapes; and (c) characteristics of transducers such as microphones, pickups, and loudspeakers.

The actual testing and troubleshooting process can be separated into two basic procedures—first, to evaluate the performance of the system or unit and determine whether there is some failure or decrease in quality; second, to locate the actual failure. It is generally possible to listen to the overall performance of a sound reproducing system by ear and rapidly determine in a very rough way whether it seems to be operating properly. However, quantitative measurements and the location of any failure in the system can only be done with the proper test instruments. These include:

A variable-frequency sine-wave oscillator

An audio-frequency vacuum tube voltmeter

An oscilloscope

A standard test record

A calibrated microphone

These are the basic instruments needed for testing sound reproducing systems and should be a part of the equipment of every service technician.

Fig. 2 shows a typical test equipment setup for checking the over-all performance of a sound reproducing system. An electrical signal, either from the signal generator or from a test record played on the record player, is fed into the amplifier (through a matching impedance in the case of a signal generator). The sound output is measured by a microphone fed to a v.t.v.m. For this purpose the characteristics of the microphone must be accurately known.

Signal Tracing

The best method of determining where a failure has occurred is by use

of the *signal-tracing* technique. The same basic method is used in locating and correcting both system failures and failures in a single unit of a system. A system failure must first be localized to a particular unit, then more intensive servicing locates the particular component failure in the unit, so that it may be corrected.

The procedure used in signal tracing to locate a system failure may be summarized as follows:

1. A single-frequency sine wave (a frequency of 1000 cps is suitable) of the proper voltage is applied to the input of the system or unit and the output terminated in the correct load resistance or in the loudspeaker. The output impedance of the signal generator should match the input impedance of the unit (a matching network may be used).

2. An oscilloscope or a vacuum tube voltmeter is used to observe the signal at progressive points in the system, starting from the input and progressing to the output.

3. If the system or unit is not operating properly, then at some point in the circuit the signal may either disappear entirely between two successive test points, or one unit may not have the correct gain or output level, or the distortion may become excessive, or any of a number of other difficulties may be encountered depending upon the exact nature of the circuit failure.

In this manner, any failure or improper operation in a complete sound reproducing system can be localized to the individual unit at fault. It is then necessary to locate the specific failure in this unit.

The unit should first be visually inspected to detect any obvious failures. Then, with power off, the resistance from "B+" to ground should be measured to indicate any direct breakdown. After the visual check and the measurement of resistance from "B+" to ground, the unit should then be turned on and the power supply voltages measured. If the plate or the heater voltages are not correct, then the failure should be looked for in the power supply or in those sections of the circuit which could cause unnatural loading conditions due to component failure.

If the power supply voltages are correct (or any break-downs have been corrected), all the tubes warm up when heater voltages are applied, and if the equipment is still not operating properly, the signal-tracing technique should be used to locate the failure in the unit. The procedure is approximately the same as for the complete system: Apply a single-frequency sine-wave signal of the proper voltage to the input of the unit through the correct impedance and use an oscilloscope or a vacuum tube voltmeter to observe the signal, starting at the input and progressing to the output. At some point in the circuit, the improper operation will be found. When an incorrect signal is located in the plate circuit of a specific tube, or in the grid circuit to which it is coupled, the following tube in the circuit should be removed from its socket to eliminate any effects reflected into its grid circuit. If removing this tube corrects the difficulty, then the trouble is probably an open connection in the plate circuit causing the grid to conduct as a diode and heavily loading the preceding plate circuit. Otherwise the error is in the circuit between the two points where the improper operation shows itself.

Once the difficulty is localized in this manner, inspect the circuit visually, then with an ohmmeter and a voltmeter to find the circuit failure.

Testing New Constructions

With chassis and circuits that have been custom-assembled and wired, it is necessary to troubleshoot and check all of the work that has been performed to locate any errors that may have been made and to insure that they are corrected. The use of the proper troubleshooting procedures can greatly simplify and reduce the amount of work and effort involved, and prevent possible damage to the equipment. Basically, the same procedure should be used when new constructions of any type of equipment are turned on for the first time:

1. Check the entire circuit against the schematic and wiring diagrams to eliminate obvious errors. A continuity check with an ohmmeter will also disclose possible errors before the equipment is turned on.

2. Connect the ohmmeter between "B+" and ground; it should show a very high resistance if the circuit is wired correctly.

3. Remove the rectifiers from their sockets before power is turned on, so that the a.c. and heater circuits can be checked without the application of plate voltage.

4. If all the tube heaters light up and the tubes become warm, and no wiring errors show up, the rectifiers should then be plugged into their sockets to obtain plate voltage.

5. Connect a resistor across the input of the unit under test, equal to the output impedance of the preceding unit in the complete system. Con-

nect the correct load resistance to its output. Then, with no signal applied to the input, there should be no output signal across the load resistor.

If there is an output voltage with no input signal, then the circuit is not operating properly. The specific circuit wiring error can often be located just by observing and classifying this output signal.

If there is excessive hum, there may be a wiring error in the heater circuit, or in the plate voltage filtering, or there may be an open grid circuit.

In amplifiers designed without negative feedback, the presence of oscillation in the output may be due to improper wiring and component layout which causes a large amount of capacitive coupling between high-level and low-level parts of a high-gain circuit.

In amplifiers where negative feedback is taken from the secondary winding of the output transformer back to an earlier stage, the presence of oscillation may mean that the feedback connection has been made to the wrong side of the secondary. Reversing the connections should remove the oscillation by correcting the phase of the feedback from positive to negative.

In some feedback power amplifiers, there may be a high-frequency oscillation which is not eliminated by reversing the connections to the output transformer secondary. This oscillation is due to high-frequency phase shift in the circuit or transformer, which causes the feedback to become positive instead of negative at high frequencies. It is generally eliminated by connecting a small condenser in series with a high resistance to ground in one of the high-impedance plate circuits within the feedback loop.

A very low-frequency oscillation (at frequencies as low as a fraction of a

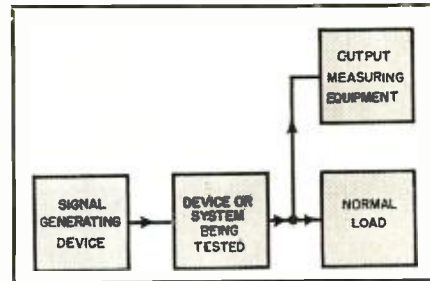

Fig. 1. Basic setup for testing audio gear.

cycle-per-second), known as "motor-boating," may exist in the amplifier due to positive feedback through the power supply at low frequencies. The cure for this is to increase the amount of plate decoupling in the low-level stages.

After this initial procedure has been followed, an audio signal should then be applied to the input of the unit. The resulting output signal will indicate whether the remaining wiring in the signal circuit is correct. If the proper output signal is obtained when the appropriate input signal is applied, then the unit is operating properly and may be used in the system. If the proper output signal is not obtained, then the difficulty can best be located by the use of the signal-tracing technique.

Record Changers, etc.

It is generally simpler to troubleshoot and service the electronic components and sections of the system than the electromechanical components. These units are usually completely assembled at the factory, and only minor repairs and adjustments can be made without seriously affecting their operation and performance. However, it is not usually necessary

(Continued on page 116)

Fig. 2. Over-all test of sound reproducing system. The electrical input from a signal generator and the sound output measured by a calibrated microphone and vacuum tube voltmeter are used. Care must be taken to avoid acoustical resonances in the room. The characteristics of the test microphone must be accurately known.

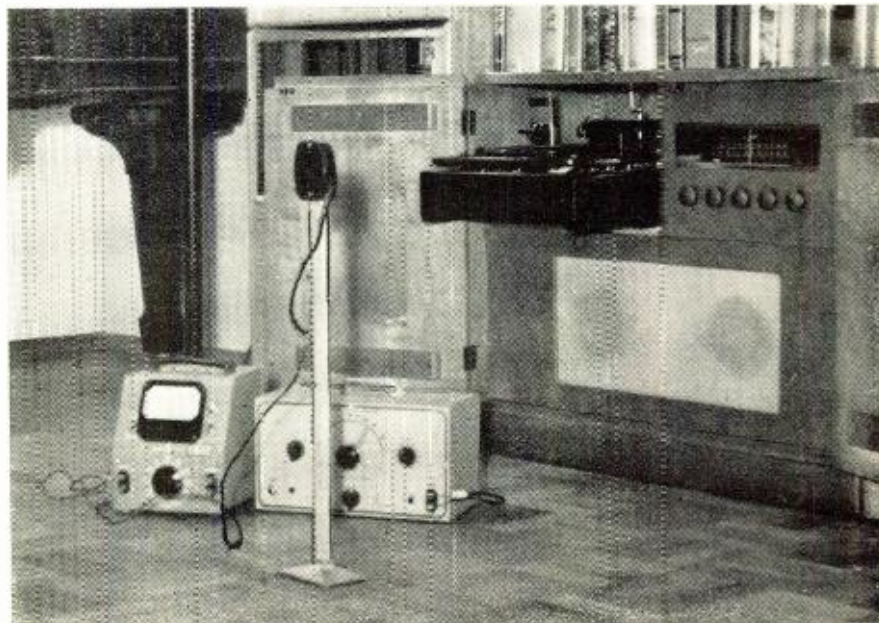

Certified RECORD REVUE

By **BERT WHYTE**

THE music lover who lives in the City of New York is a very lucky person. Few places in the world can offer such quantity and quality of musical events—operas, choral works, symphony concerts, chamber recitals. All these and more are available to the New Yorker. If the music lover is a hi-fi fan, New York is seventh heaven. Live concerts on high quality FM are common, along with recorded music programs from some of this country's finest FM stations. If our hi-fi fan wants to hear a new piece of equipment, he has dozens of hi-fi distributors who will cater to his demands. When records are to be purchased, he can whet his musical appetites in famous record stores, where the "Golden Rule" is not silence, but "thirty percent off list." I could go on and on. It's no wonder many people envy the luck of the New Yorker.

There is little chance of anyone becoming bored with the musical life of New York. Take for instance this nifty idea I came across not long ago. I was in N.Y. with a few friends, fairly late in the evening. We had just come from a recording session and everyone was hungry and thirsty. Now if there is one thing New York is more amply endowed with than anything else it's eating places. After the usual suggestions that we eat, "in the restaurant," or "the cute little place on 48th," someone in the crowd insisted that we go to the Prince George Hotel. He said we would find something really unique in their restaurant. With no disrespect intended, the Prince George Hotel would never have entered our minds as a place to eat. It's sort of out of the main stream of activities, on the lower part of Madison Avenue. The hotel has seen better days and is now what you might call "genteel." It is neither high class nor is it shabby or seedy. More out of curiosity than anything else we decided to go. As we entered the dining room, a very large and handsome room in the old tradition, I looked to the right and what I saw nearly floored me! There was a sort of counter about 12 feet in length at that end of the room. Behind this counter was a very attractive young brunette presiding over a microphone,

a professional *Fairchild* transcription table and turret arm, and several high power amplifiers! In three display racks in front of the counter were the familiar bright jackets of classical LP records. In the wall behind the counter was a large screen or grille which concealed four 15-inch woofers, four tweeters, and associated networks in a large theater-type baffle. There could be no doubt! It was a hi-fi system, by Gad! After we were seated I noticed what looked like a menu on the table. And so it was, except that it was a musical menu. On this were listed selections ranging from Bartok's "Miraculous Mandarin" to the "Nutcracker Suite." You checked off what you would like to hear and the waiter conveyed this to the young lady in charge, and presto!, believe it or not, up comes your selection and it is played at a good room-filling level! No background music here. I looked around to see if there would be squawks about the high volume from some of the other patrons. Far from this, they were listening raptly. The system was very good and everything was well balanced. After the initial shock wore off, I decided to find out how long this sort of thing had been going on. The young lady was most helpful and introduced me to Mr. John Andrews, head of a firm called "Music of Distinction." The principal activity of this company is wired music, but in this instance, this was the initial effort with a high-fidelity installation, *not* intended for background music use. The evening I was there marked the third week since its inception. And what was the public's reaction? Shock at first, of course, but it was not long before the room became known to the hi-fi bugs and it was smoother sailing from then on. Most record companies cooperate with the venture and all the latest releases can be heard. Yes, people still talk while the selections are being played, but it is the people who are subdued, *not* the music. I think you will agree this is indeed something unique and something which might well be introduced in other cities. After enduring the mis-

The opinions expressed in this column are those of the reviewer and do not necessarily reflect the views or opinions of the editors or the publisher of this magazine.

erable audio and corny music on background systems for so long, this was a treat. Yessir! New Yorkers are lucky people. They have everything in music. But you can't tell me there aren't plenty of other towns capable of supporting a high-fidelity eating emporium. P.S. The food was good too!

**WAGNER
LOHENGRIN**

Chorus and orchestra of the Bayreuth Festival 1953 conducted by Joseph Keilberth. Lohengrin-Wolfgang Windgassen; Elsa-Eleanor Steber; Ortrud-Astrid Varnay; Telramund-Hermann Uhde; King Henry-Josef Greindl; Herald-Hans Braun. London LLA-16. RIAA curve. Price \$29.75.

This is the third version of "Lohengrin" to appear on LP and by all odds the best. The fact of primary importance is, of course, the authenticity of the performance. Since this "Lohengrin" was recorded at an actual concert of the 1953 Bayreuth Festival, there can be no question on this point. Naturally, mere authenticity in itself is not a guarantee of a good performance. So it is a happy thing to report that this is a good performance, and the recording has much to recommend itself over the competing versions. One thing you must accept from the start. This is a typical "actual concert" recording with all that this implies. Coughing, creaking of music stands and risers, shuffling of feet, all manner of extraneous noises are heard in quantity. Either you feel that these "noises" lend an "on hand atmosphere" to the recording (as I do) or they annoy you. It must be said that although there is a large quantity of noise, most of it is at such a level that it does not intrude upon the score.

The cast is well chosen. Eleanor Steber is in magnificent voice and her "Elsa" is a brilliant portrayal. Certainly this is one of Miss Steber's most effective roles. Astrid Varnay is perfect as Ortrud, a role in which she is familiar to most opera-goers. The "Lohengrin" in this recording, Wolfgang Windgassen, is unknown to me. His performance indicates he is thoroughly familiar with the demands of the role. While he has a strong, robust voice, there was evidence of straining at times and at other times his tone was somewhat nasal. In spite of these minor shortcomings his is the best "Lohengrin" of the three available recordings. Mr. Windgassen lends an air of delicacy, a sensitive restraint that is refreshing in contrast to the usual German heavy-handedness. The other soloists are competent but not outstanding. Choral work is good and the famous "Wedding March" is well done.

Sound on this recording is generally good, but quite variable. Some parts are very clean and wide range, other parts sound constricted and compressed. String tone is good with some edginess, brasses come through best of all and percussion is weighty but at

(Continued on page 107)

MAGNETIC RECORDING

1888 to 1954

By
LEON A. WORTMAN

EVER since the beginning of time, man has been intrigued with the sound of his own voice—and frustrated by his inability to reproduce it. History reports that as early as the 3rd Century B.C., Heron of Alexandria attempted to devise a machine that could talk or make animal sounds. However, it wasn't until the year 1791 A.D. that a "talking machine" was invented which could actually speak short sentences. These were man's early efforts to create or generate sound.

An amateur scientist in the year 1857 described an invention which he named the "Phonautograph." It was an ingenious device which traced a visible pattern of the sound of the human voice. It is almost frightening to think of the dazzling possibility that apparently had completely escaped the amateur scientist, the possibility of simply reversing the process and getting back the original sound which he had recorded. But, man was not to be easily deprived of this scientific advancement and within a few years of 1857 a number of people suggested the principle of the phonograph. One of them, l'Abbé Lenoir, even used the name "Phonograph" in a technical paper in 1877, the year Edison built his machine. Thus man, after so many thousands of years of anxiety, had discovered one mechanical means of recording and reproducing sounds and intelligence. This, as we know, was only the beginning.

In 1888 the magazine *Electric World* published an article by Oberlin Smith in which he suggested the use of a permanent-magnet recording technique. He proposed that a cord or silk thread be impregnated with steel dust or short clippings of fine steel wire. He also suggested, but thought impractical, a length of steel wire for magnetic recordings. Unfortunately, Mr. Smith never actually built a magnetic recording machine.

In the latter half of the 19th Century any boy who was interested in electricity considered telephone work to be the highest goal of attainment in an ambitious life. All young scientists dreamed of achieving their bit of success in that field. One such young man was Valdemar Poulsen, an unsuccessful

medical student in Denmark. The ambitious young Poulsen decided to leave medicine and turn to other pastures. In 1893, when he was 24, he obtained an appointment as a troubleshooter for the *Copenhagen Telephone Company*.

We will probably never know how Poulsen got his ideas for practical magnetic recording, but his ideas were quite unique and completely original. Many great inventions are challenged every year and the court records are filled with histories of litigations, claims and counter-claims. But no one other than Valdemar Poulsen has ever claimed to have invented the "Telegraphone," as his magnetic recording machine, the forerunner of present day tape recorders, was named in his original patent application in Denmark in 1898.

The "Telegraphone" won the Grand Prix in the 1900 Paris Exposition. It created a sensation. People came from everywhere to see it. Technical journals and contemporary newspapers were filled with stories, mentions, and references to it.

In the United States Poulsen was awarded patent number 661,619, dated November 13, 1900. Poulsen used a steel wire, 1/100th of an inch in diameter, drawn rapidly past magnetic cores surrounded by coils through which sound currents were passed. When the wire was again passed through similar magnetic cores, voltages were generated in their windings corresponding to the original currents. It worked extremely well, when judged by the standards then prevailing. However, frequency response was quite restricted and noise was high and dynamic recording range limited to ap-

proximately 20 decibels. According to reports of that day, everyone who heard it was enchanted by the naturalness of the sound reproduction! The "Telegraphone" operated with earphones, but everyone assumed that this difficulty would be overcome shortly. Actually it was not overcome until the development of electronic amplifiers, about 25 years later.

On the commercial side, Mr. Poulsen came to America seeking investment capital. In 1903 the *American Telegraphone Company* was formed with a capital stock of \$5,000,000 at a par value of \$10.00 a share. The company's objective was to manufacture "Telegraphones" for use as dictating machines and telephone recorders. The machine was capable of ½ hour recording time, with the steel wire moving at the extraordinarily high velocity of 7 ft. per second. Compared with early mechanical dictating machines, the longer playing time, the relatively low distortion, and the fact that the wire could be used over and over again made strong "selling" points.

It was terribly unfortunate for the company and its investors that certain of the operating features became strong "unselling" points. The speed at which the wire traveled in recording was just about as fast as was practical at that time, making it impossible to speed up the rewind time. This meant that before playing back a reel of magnetic wire which contained dictation, one had to wait. What was worse, threading a "Telegraphone" was much more involved than the simple procedure of placing a cylinder on a mechanical dictating machine. Eventually the

(Continued on page 124)

Tape and wire recording are not as "modern" as many would like to think. The technique is almost sixty-six years old!

FUNDAMENTALS OF

COLOR TV

By MILTON S. KIVER

Pres., Television Communications Institute

CHROMINANCE CIRCUITS

Part 5. Analysis of the chrominance circuits of three typical color TV receivers using the 3-gun color tube.

IN the previous article we followed the full video signal (containing both black-and-white and color components) from the antenna to the video second detector. After detection, we had the 0 to 4 mc. black-and-white signal plus the color information. The latter was present as sidebands of the 3.58-mc. color subcarrier which meant that the color signal would require additional detection (or demodulation) before we could use it for application to the color picture tube. Thus, detection in a color receiver is a two-step process. First we remove the carrier which brought the full signal to the receiver. Then we must remove the color subcarrier so that the color video frequencies which it possesses may become available. It is important to keep this distinction in mind.

The black-and-white portion of the full signal is amplified by one or two video stages and then transferred to the matrix. While this is happening, the color subcarrier and its sidebands are diverted to the chrominance section of the receiver. See Fig. 1. This

section is concerned only with the color portion of the signal and it consists basically of a bandpass amplifier, the *I* and *Q* demodulators, and *I* and *Q* amplifiers and phase splitters. The output of the system is fed to the matrix network where, in combination with the monochrome or *Y* signal, we re-obtain red, green, and blue voltages which are then applied to the proper control grids of the tri-gun color tube.

The complete circuit of the chrominance section of a television receiver is shown in Fig. 2. The incoming signal, which contains both chrominance and luminance components, is applied to the grid of the bandpass amplifier. This tube will permit the signals to pass at all times except during the horizontal retrace period (including the color burst) when the tube is keyed to cut-off by a negative voltage pulse obtained from a winding on the horizontal output transformer. The pulse is applied to the screen grid of the bandpass amplifier through a .01 μ f. condenser. The tube is keyed out during the color burst interval in order to

avoid unbalance in the color background due to the d.c. restorers clamping on the color burst rather than on the tips of the sync pulses.

The control grid of the bandpass amplifier also operates in conjunction with a color killer stage. This latter stage (not shown in the diagram) biases the bandpass amplifier to cut-off when no color signal is being received. However, when a color signal is active, the color killer stage removes its bias and the bandpass amplifier is able to function normally. In this way we avoid having spurious signals pass through the color system when it is inactive and produce random colors on the screen.

A filter in the plate circuit of the bandpass amplifier has a bandwidth of approximately 2.4 to 5.0 mc. See Fig. 3. This enables the circuit to pass only that portion of the total signal containing the color information. The rest of the signal, containing only monochrome or luminance voltage, is sharply attenuated.

A chroma control terminates the filter and with it the set viewer can adjust the depth of saturation of the colors in the picture. The need for such adjustment may arise because of the level of the surrounding light in the room, because of the personal prefer-

Fig. 1. Block diagram of the chrominance section of a color television receiver. The exact circuitry varies from set to set.

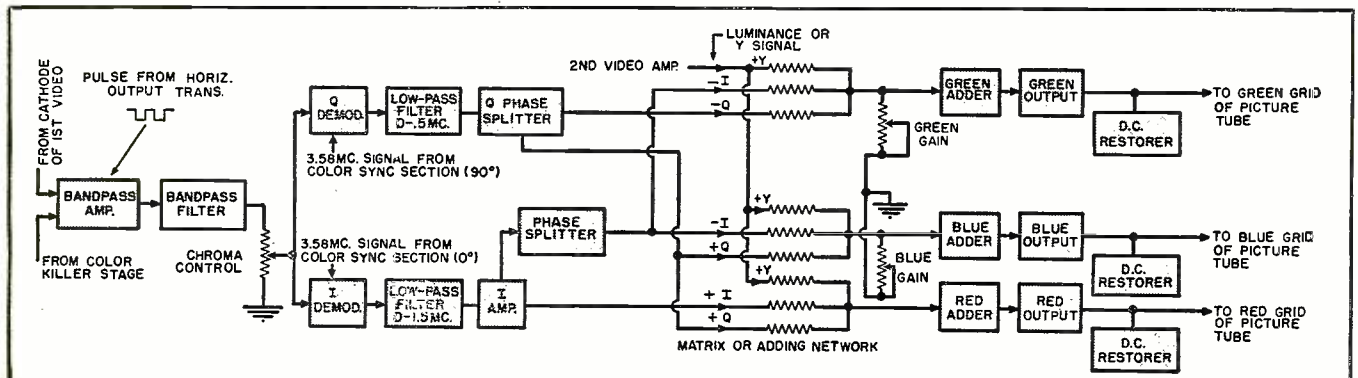

ence of the viewer, or because of variations in the color circuits of the receiver. Whatever the reason, the control is not a particularly critical one and it may be varied over a considerable range without overly distorting the picture as far as its tonal values are concerned.

From the chroma control, the signal is fed in equal measure to the control grids of the *I* and *Q* demodulators. At the same time both tubes receive, at their suppressor grids, a 3.58-mc. signal. The latter represents the missing color subcarrier and is needed in the demodulator to properly reproduce the original *I* and *Q* color video signals. The 3.58-mc. signal which the *I* demodulator tube receives is 90° out-of-phase with the 3.58-mc. voltage applied to the *Q* demodulator. This is required since the *I* and *Q* sidebands themselves are 90° out-of-phase with each other.

The detected *Q* signal appears at the plate of *V*₁₃₃ and is passed through a 0 to .5-mc. filter before being applied to a *Q* phase splitter. The latter stage then supplies negative (at its cathode) and positive (at its plate) *Q* signals necessary for the matrixing network into which the signals are fed.

The 3.58-mc. color subcarrier signal is not required beyond the demodulator and it is shunted away from the grid of the phase splitter by the series-resonant trap *L*₃₀₁, *C*₂₇₀.

In the *I* channel, the detected *I* signal is passed through a 0 to 1.5-mc. filter and then through an *I* amplifier and an *I* phase inverter before being applied to the same matrixing network. Positive *I* signals for the network are obtained at the plate of the *I* amplifier; negative *I* signals appear at the plate of the following phase inverter.

A .5 microsecond delay is designed into the *I* system and its purpose is to slow down all *I* signals so that they keep in step with the corresponding *Q* signals. The time it takes a signal to pass through a system is found to be inversely proportional to the bandpass of that system. That is, the narrower the bandpass, the longer it takes for signal passage. In a color receiver, the *Q* channel has the narrowest bandpass (0-5 mc.) and its signals suffer the greatest amount of delay. The bandpass of the *I* channel extends from 0-1.5 mc. and so its signals are not slowed down as much as the *Q* signal. Finally, the *Y* or monochrome channel has the widest bandpass (0-3.2 mc.) and its signals are delayed the least in passage.

To insure that the *I*, *Q*, and *Y* signals arrive at the matrix at the same instant, it is necessary to artificially increase the delay time of the *Y* and *I* signals to that of the *Q* signal. In the *Y* channel, this is done by inserting a 1.0 microsecond delay line. In the *I* channel, the additional delay required is on the order of .5 microsecond. While no special delay line is employed in the *I* circuit of Fig. 2, the over-all characteristics of the system shown have been so fashioned that this added delay is actually present in distributed

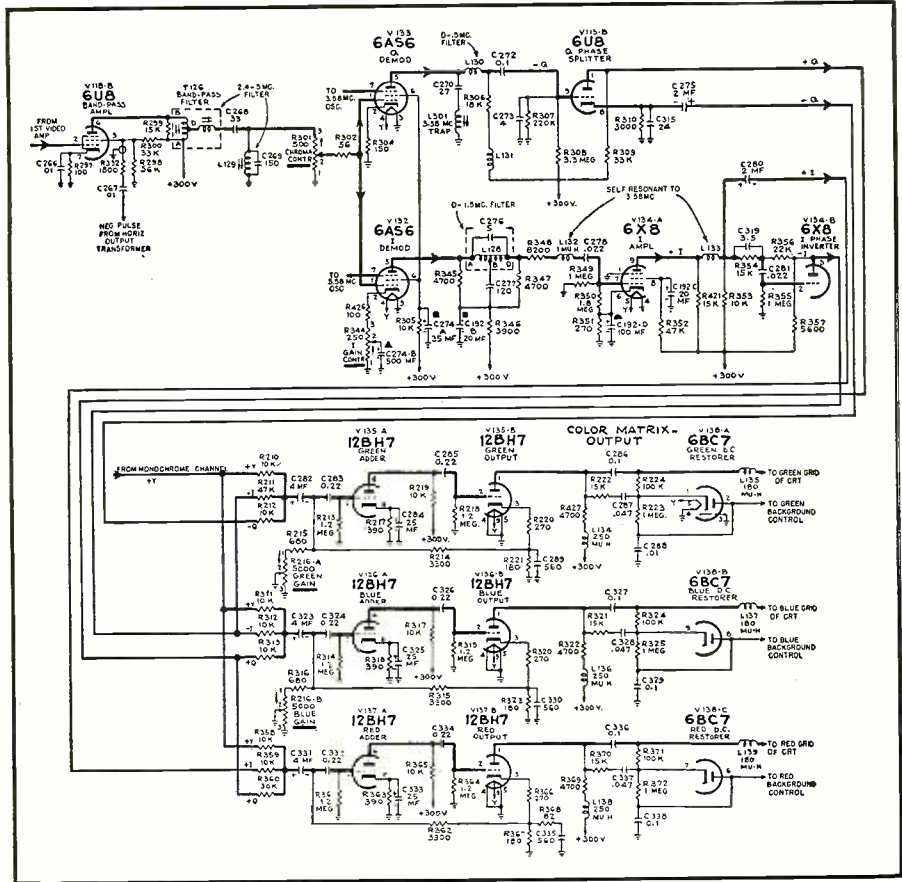

Fig. 2. Schematic diagram of the chrominance circuits of an RCA color TV receiver.

form. That is, each section of the circuitry contributes some share toward the delay and by the time the signal has arrived at the matrixing network, it has been moved back in step with the *Q* signal.

Note that the *I* channel has one amplifier stage more than the *Q* channel. This is due to the narrower bandpass of the *Q* channel. A narrower bandpass permits us to use higher load resist-

Editor's Note: Part 1 of this series, which appeared in the March, 1954 issue, explained color mixing and its application in color TV. Part 2, appearing in the April issue, described the NTSC color signal. The block diagram of a typical color TV receiver was described in the May issue. The June article in this series described the tuner, sound, and some of the video circuits of a color receiver. In view of the many requests received, RADIO & TELEVISION NEWS will publish this series in reprint form. The first three parts are in a single unit (50 cents), the balance will be reprinted in individual parts at 20 cents each. For quantities of 50 or more, write for quotations. Address your inquiries to RADIO & TELEVISION NEWS Reprint Editor, 366 Madison Ave., N. Y. 17, N. Y.

ances, with a corresponding increase in gain. The difference in gain of the two demodulators is on the order of almost 7 to 1. For a 2-volt peak-to-peak signal input, the peak-to-peak value of the signal at the plate of the *Q* demodulator is 20 volts, while at the plate of the *I* demodulator it is only 3 volts.

The Matrix Section

The matrix or mixing section is the place where the *I*, *Q*, and *Y* signals

combine to reproduce the original red, green, and blue signal voltages. There are a variety of mixing networks possible, but the most economical and straightforward is the resistive network. See Figs. 2 and 4. From the NTSC specifications, the *I* and *Q* signals have the following composition:

$$I = -.27(B-Y) + .74(R-Y)$$

$$Q = .41(B-Y) + .48(R-Y)$$

These represent two equations and if we solve them simultaneously for *B-Y* and *R-Y* we obtain:

$$B-Y = 1.72Q - 1.11I$$

$$\text{or } B = Y + 1.72Q - 1.11I$$

$$\text{and } R-Y = .62Q + .96I$$

$$\text{or } R = Y + .62Q + .96I$$

Now, what do these equations tell us? They reveal that if we take 1 volt of signal from the *Y* channel, and 1.72 volts of positive *Q* voltage from the *Q* channel, and 1.11 volts of negative *I* voltage from the *I* channel, we obtain 1 volt of blue signal. Of course, we are not restricted to voltages this small; we may use much larger voltages, as long as we maintain the same relative relationship between the *I*, *Q*, and *Y* voltages taken from these three channels feeding into the matrix network.

The red signal is obtained by using different proportions (and polarities) of the *Y*, *I*, and *Q* voltages than were used for blue. This is indicated by the last equation and the red signal is then dealt with separately.

Still missing is a green voltage and this can be obtained from still another equation which is also derivable from the NTSC specifications. That is:

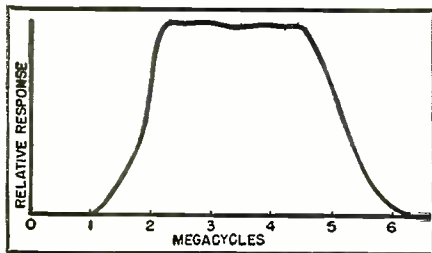

Fig. 3. Response of the bandpass filter in the plate circuit of the bandpass amplifier of the circuit in Fig. 2.

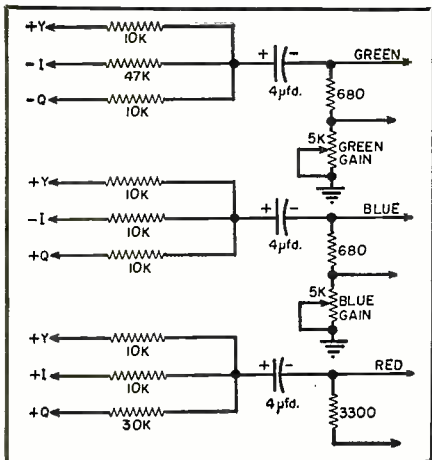

Fig. 4. The matrix network for combining the Y, I, and Q signals in the proper proportions to give red, green, and blue signals in circuit of Fig. 2.

$(G-Y) = -.51(R-Y) - .19(B-Y)$
and from this, by a little mathematical manipulation,

$$G-Y = -.64Q - .28I$$

or

$$G = Y - .64Q - .28I$$

Hence, within the same matrix, we can obtain the desired green signal by combining 1 volt of Y signal with .64 volt of negative Q signal and .28 volt of negative I signal.

The foregoing equations make it evident why a resistive matrix network can work and also why positive and negative I and Q voltages are required,

whereas from the Y channel only a single positive signal is needed.

Let us return now to Fig. 2 and briefly check the red, green, and blue amplifiers to make certain that the voltages they receive at least conform in polarity to the voltages indicated in these equations.

The green amplifier (or "adder" as it is labeled on the diagram) receives a Y voltage, a negative I voltage, and a negative Q voltage. The circuit, of course, is so designed that these signals are present in the ratio of 1 to .28 to .64.

The blue amplifier receives a Y voltage, a negative I voltage, and a positive Q voltage. Finally, the red amplifier receives a Y voltage, a positive I voltage, and a positive Q voltage.

Each of these voltages is passed through two video voltage amplifiers and then applied to its respective control grid in the tri-gun picture tube. Bandpass of each system is on the order of 3.2 mc. Over-all gain controls for the green and blue channels are provided to permit the gains of these sections to be adjusted relative to the red channel. In the initial tri-gun picture tubes that were made, the efficiency of the red phosphor was lower than the efficiencies of the green and blue phosphors. To compensate for this, more drive was required at the red control grid, or what is the same thing, less drive for the green and blue grids. Adjustment of the two gain controls served to satisfy this condition. A d.c. restorer is included in each path to bring each color signal to the proper level before it is applied to the picture tube.

The chrominance channel of another color television receiver is shown in Fig. 5. The complete signal is brought to the grid of the bandpass amplifier from the master contrast control. The tube admits all of the signal except the color burst because during this interval it is keyed off by a negative pulse applied to the screen grid.

In the output circuit of the bandpass amplifier there is a 2.1 to 4.2 mc. band-

pass filter terminating in a 500-ohm chroma control ("color intensity control"). As before, the chroma control governs the amount of color signal reaching the rest of the chrominance section and hence it regulates the intensity or saturation of the colors viewed on the picture tube screen. The color signal receives an additional stage of amplification beyond the chroma control and then it is fed in equal measure to both the I and Q demodulators.

The demodulators in this system are also the recipients of two additional voltages. One voltage, in the form of a negative biasing voltage, is obtained from a color killer tube. When a color signal is being received, this bias voltage drops to zero and both demodulators conduct. On the other hand, when no color signal (and hence, no color burst) is present, the negative voltage from the color killer tube is high enough to cut both demodulators off. The over-all effect, then, is the same in this system as in the previous one, although the approach is slightly different.

The second voltage applied to the I and Q demodulators is provided by a 3.58-mc. generating section. This is the missing color subcarrier and is applied in equal measure but with a 90° phase difference to each demodulator. The tubes then mix this signal with the incoming color sidebands to provide the detected I and Q color signals at the output.

In the I channel, there is a 0-1.5 mc. low-pass filter, an amplifier and a phase splitter. Also, sufficient delay is incorporated in this circuit to force the I signal components to keep in step with the Q signal components. Positive and negative I signal voltages are available at the plate and cathode terminals, respectively, of the phase splitter for use in the matrix network.

The Q channel is somewhat less extensive, containing only a phase splitter and a 0-5 mc. low-pass filter. The output from this section, too, is fed to

(Continued on page 75)

Fig. 5. Schematic diagram of a chrominance section with a chroma amplifier stage.

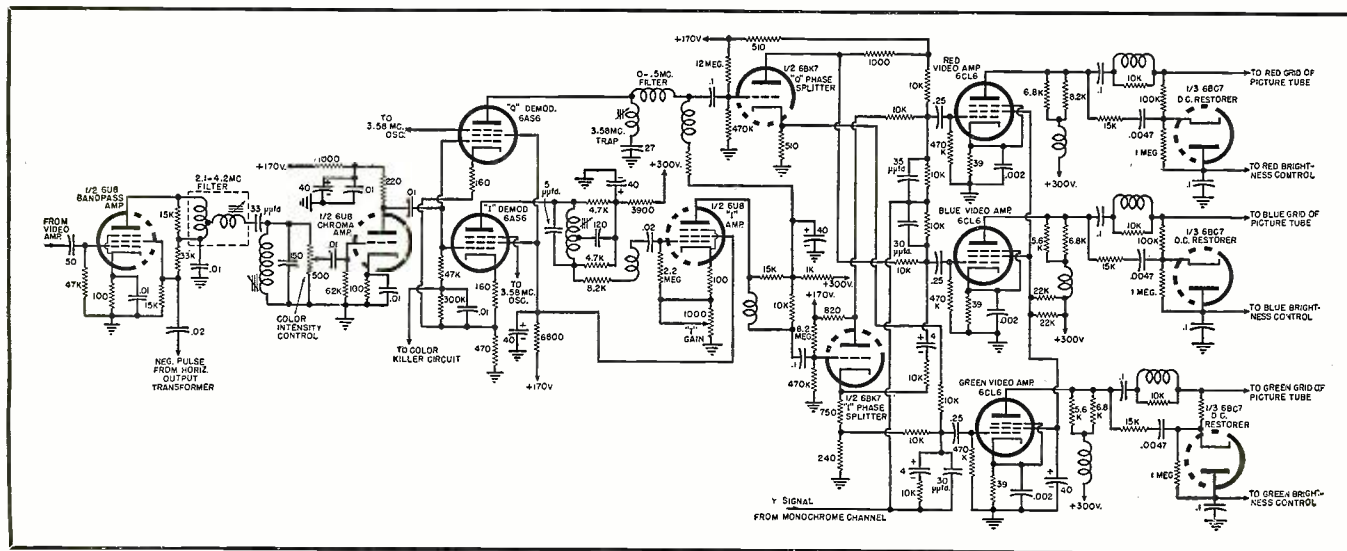

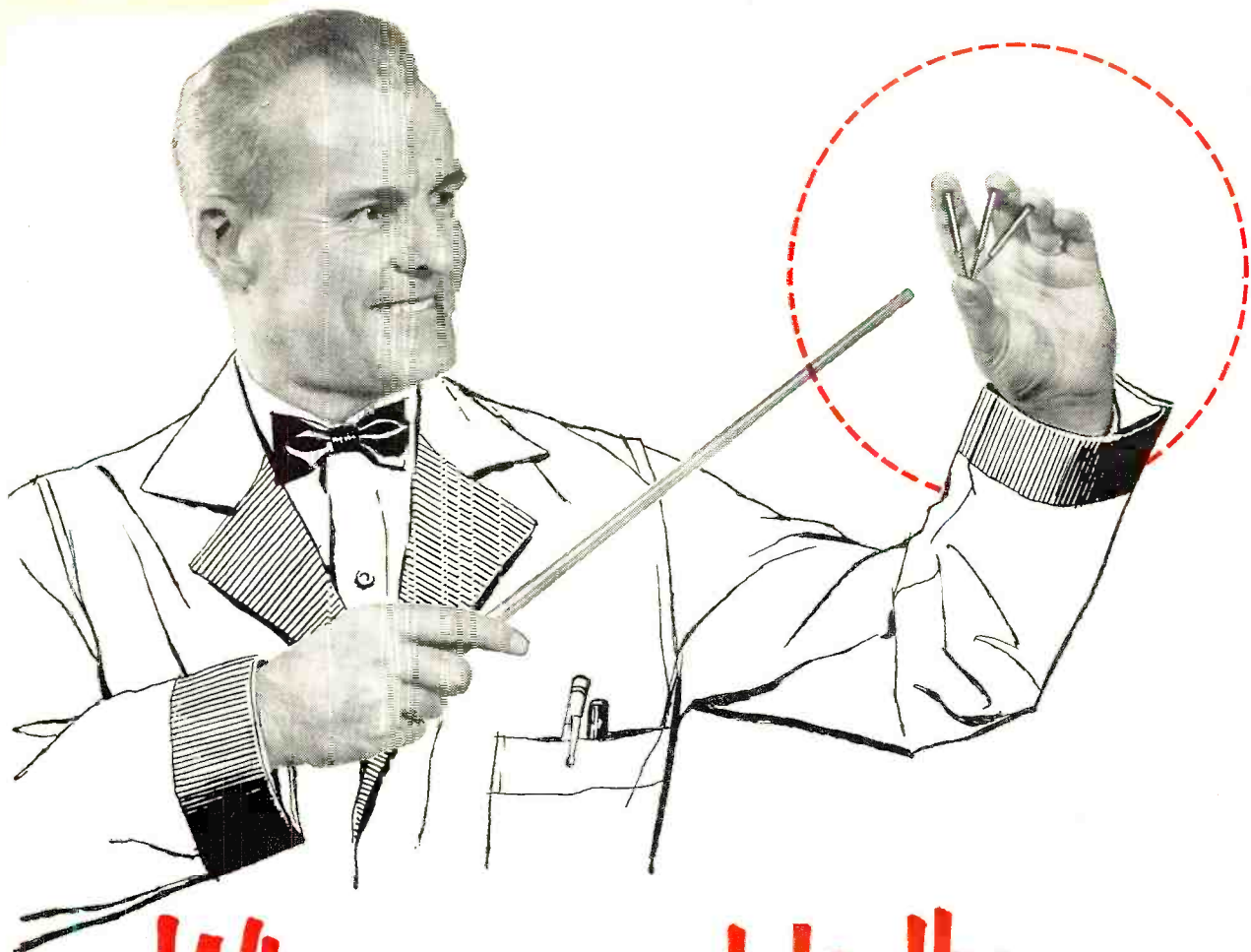

When you get to the core...

DELCO RADIO MAKES ITS OWN OF POWDERED IRON FOR HIGH-QUALITY PERMEABILITY-TUNED COILS!

To insure quality performance, Delco Radio exercises rigid control over the components used for both original equipment and service parts in its auto radios.

For example, the powdered-iron cores of Delco Radio's RF, IF, or tuning coil assemblies are made to exacting specifications at the Delco Radio plant. Powdered iron is treated with a binding agent and then compressed into shape by a special machine. Skilled craftsmen attach the connector, and the head end of the core is notched for the tuning tool blade. The core is now ready to be inspected and sent to the tuner department.

This careful manufacturing results in greater customer satisfaction—always. Delco Radio service parts, made by the world's largest manufacturer of auto radios, are available through your UMS Delco Electronic Parts Distributors.



FINAL TEST ON IRON CORE ASSEMBLIES AT DELCO RADIO. Here, all iron core assemblies are carefully checked for permeability and separated into very narrow tolerance permeability groups.



DELCO RADIO

DIVISION, GENERAL MOTORS CORPORATION, KOKOMO, INDIANA

DISTRIBUTED BY ELECTRONICS WHOLESALERS EVERYWHERE

A GENERAL MOTORS PRODUCT   A UNITED MOTORS LINE



International SHORT-WAVE



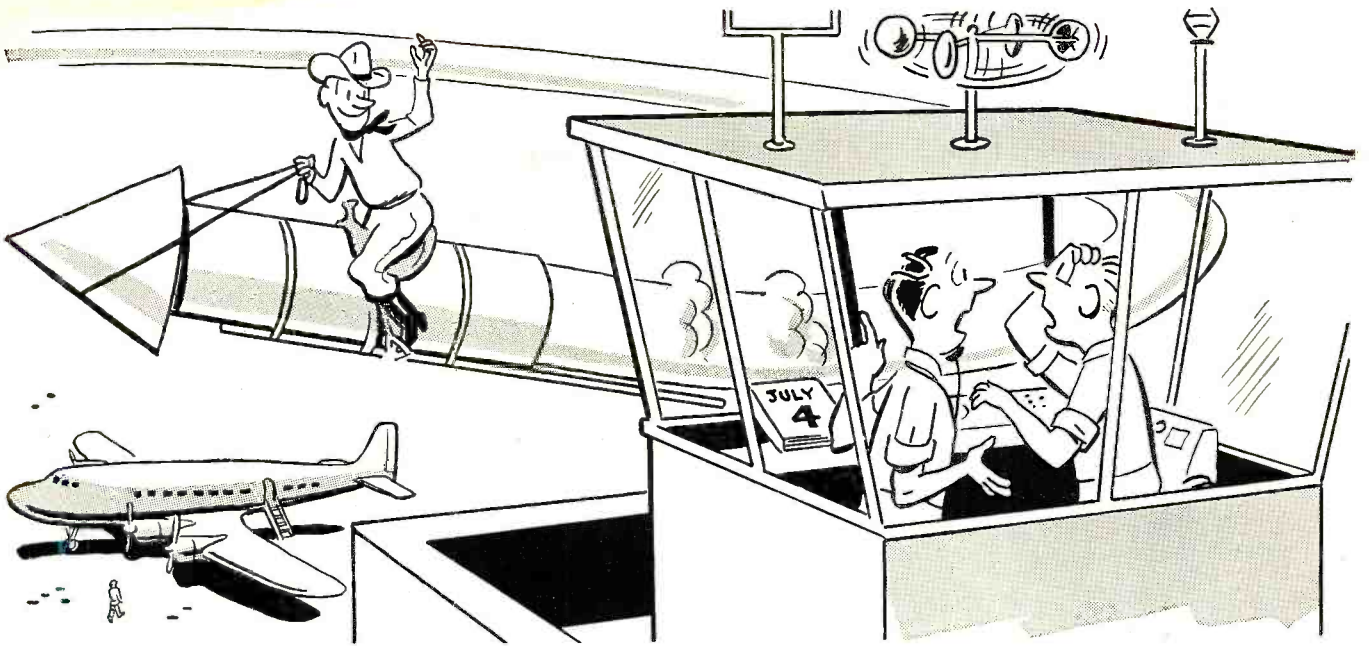

"He says he's heading for WALTER ASHE where the "Surprise" Trade-Ins come from"

AMATEUR GEAR



ELMAC AF-67
TRANS-CITER
Net \$177.00



NEW JOHNSON VIKING RANGER TRANSMITTER-EXCITER KIT. 75 watts input on CW, 65 watts on phone. Bandswitching 160 through 10 meters. Self-contained VFO, modulator and power supply. TVI suppressed. Less tubes. Model 240-161. Net \$179.50



HALLICRAFTERS SX-71 Less speaker. Net \$249.95
Matching speaker. Net \$19.95

Most economy-minded folks will make a beeline for a bargain. And there's no better bargain anywhere than the money saving kind made possible by our "Surprise" Trade-In Allowance on your used test and communication equipment. Get your trade-in deal working today! Wire, write, phone or use the handy coupon below.

TEST EQUIPMENT

The Perfect Pair for FM-AM-TV Servicing

PRECISION APPARATUS
Multi-Band Signal and Marker
Generator. 88-240 MC range.
Model E-200C. Net \$76.93

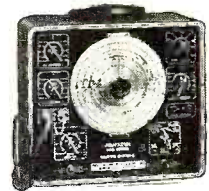

PRECISION APPARATUS
Wide Range Sweep Signal
Generator. 2 to 480 MC range.
Model E-400. Net \$136.95



All prices f. o. b. St. Louis • Phone Chestnut 1-1125

Walter Ashe
RADIO CO.
1125 PINE ST. • ST. LOUIS 1, MO.

July, 1954

FREE CATALOG!

R-7-54

WALTER ASHE RADIO COMPANY
1125 Pine Street, St. Louis 1, Missouri

Rush "Surprise" Trade-In Offer on my _____

for _____ (show make and model number of new equipment desired)

Rush copy of latest Catalog.

Name _____

Address _____

City _____ Zone _____ State _____

**Send
for
your
copy
today**

MAC'S RADIO SERVICE SHOP

By JOHN T. FRYE

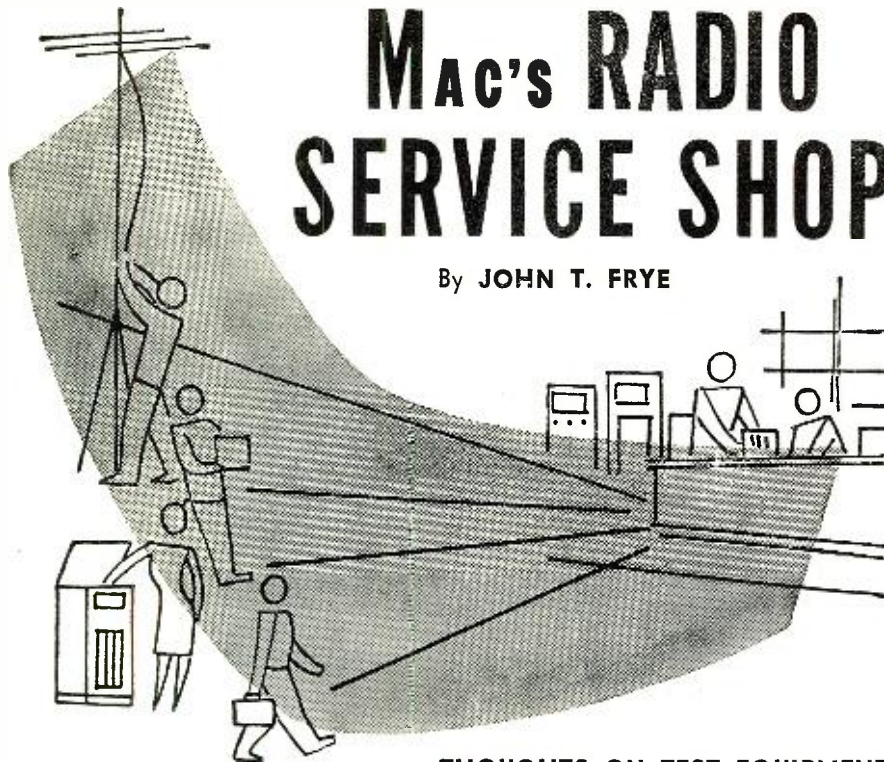

THOUGHTS ON TEST EQUIPMENT

MAC had come down to his service shop this warm July evening to try out some new test records and a test tape he had just received. While he was busy running the signal-to-noise checking portion of the test tape through the recorder, he heard the front door open and bang shut.

"Ha!" came the accusing voice of Barney, his assistant, as the youth strode through the door of the service department. "You trying to put something over on me? What's the idea of sneaking down here after hours? What're you holding out on me?"

"Now calm yourself, Buster, before you melt a connection," Mac said soothingly. "It just happened these records and tapes came in late this afternoon after you had gone home, and I was eager to try them out at a time when I would not be interrupted—I hoped," he added pointedly.

"You could have let me know," Barney grumbled. "I saw a weather forecast for heavy thunderstorms for tonight, and I came down to be sure I had pulled the master bench switch. Gosh," he broke off, as his eye caught sight of a stack of red, yellow, green, and blue, 5- and 7-inch plastic reels, on two of which were wound rolls of green and blue plastic tape, "are those the test tapes?"

"Nope. Those are just some of the new colored reels and tapes recently put on the market. I'm going to try and work out a color-code scheme for filing our recordings that will let us know at a glance if a particular reel of tape is important not-to-be-erased material, is recorded from the microphone or by direct pickup, or if it contains blank tape, etc. Since we have five colors of reels, including the transparent, and three colors of tape, count-

ing the conventional brown, the possibilities are considerable, and I want to work out a system that is simple and easy to remember but that will allow us to file our tapes under many color-keyed listings.

"The test tape is on this five-inch reel," he said. "It and those test records over there are the ones we read about in that article in the May issue of RADIO & TELEVISION NEWS as being released by the *Dubbings Company*."

"Say, you're really becoming pretty loopy about this tape business, aren't you?" Barney asked quizzically.

"Couldn't you change 'loopy' to 'interested'?" Mac asked. "I'll confess I'm greatly intrigued by the possibilities of tape recording, especially now that it is possible to record light images and other information on tape as well as sound. I keep thinking that possibly there is something here that will solve a problem that is beginning to be a big one."

"What's your problem?" Barney wanted to know.

"It's not just my problem; it's the growing problem of every service technician. In brief, it seems to me that the test equipment situation is getting somewhat out of hand. We've reached the point where our service instruments are more expensive, more complicated, more subject to trouble, and harder to learn to use than the apparatus upon which we work. If things keep on at the present rate, it does not take too great a stretch of the imagination to picture a time soon when the technician will be so busy studying and selecting new service equipment, learning how to use it, and keeping it in repair that he will not have any time left over at all for doing service work."

Barney grinned broadly at this pic-

ture. "Guess it is not too far-fetched at that," he conceded. "The other day I counted up a total of sixty some tubes that are in use in just our test equipment. Sixty tubes and their associated circuits represent a lot of room for trouble. Much of that equipment, too, must or should be constantly checked to be certain it is operating as it ought to. As a 'ferinstance,' we do not depend upon the calibration of the sweep generator but use our marker generator to indicate exact frequencies; then we do not rely on the accuracy of the marker generator but check it against a crystal oscillator; and finally, we do not take the crystal oscillator frequency for granted but check it against WWV. Sounds kind of wacky, doesn't it?"

"Sure does," Mac agreed, "and that's only one example. The increasing number of articles we see in service magazines on how to check, how to maintain, and how to use the many, many service instruments considered essential for present-day radio and TV servicing is a key to how serious this state of affairs is becoming. You've got to keep in mind that all thought and energy expended on service instruments is so much lost motion as far as direct addition to your income is concerned. When you are studying and working on service instruments, you could be working on a radio or TV set and being paid for doing so."

"But if you really know your service instruments and if you keep them in good shape, you can do more and faster service work," Barney argued.

"I'm not disputing that," Mac explained; "but what I am trying to say is that anything that takes your attention away from the essential job of repairing sets cuts into your income. Service technicians are constantly being told they should become better businessmen, which is another way of saying they should evaluate all their procedures strictly according to whether or not these activities increase their net income. Up to a point, time and money spent on service equipment will still yield an increased income in spite of the fact that the money is subtracted and the time is diverted from the service business proper. Eventually, though, the law of diminishing returns whittles down this increase until it no longer exists. I'm thinking that point is not too far away."

"What can be done about it?"

"Candidly, I'm not sure anything can; but I've some ideas I'd like to see tried. Manufacturers could help a lot if they would prepare service instructions with an eye to the equipment found on a typical service bench rather than the instruments on hand in their own engineering laboratories. I don't mean they should try to write up this service data so that everything can be done with a v.o.m.; but at the same time I feel that service instructions calling for special high-gain, broadband oscilloscopes, sound and video

(Continued on page 103)

**Mallory
Midgetrols[®]**

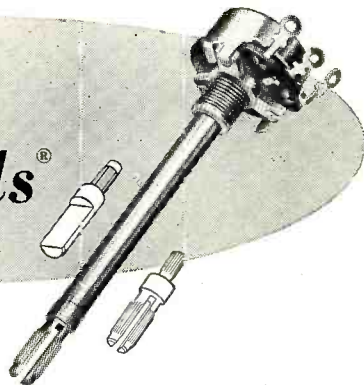

Right for You and Your Customers

Because of excellent drift characteristics and extremely accurate taper curves, Mallory Midgetrols give your customers the set performance they want—long and trouble-free. Mallory Midgetrols are engineered for precision performance in both TV and radio sets despite variations in temperature and humidity.

Because of simplified design and construction, Mallory Midgetrols are easy to install quickly. Round, tubular shafts can be cut fast, accurately . . . are easily adapted for split-knurl, flatted, or set screw type knobs. And you can attach AC switches without control disassembly.

Because from every angle—quality, price, performance—Mallory Midgetrols are right for you . . . and your customers. Use them always.

Look at ALL 3 Features of this Mallory Control "Deal"

- (1) With the special Mallory Control Kit you get a selection of controls and switches that give coverage of more than 50 radio and TV set models.
 - (2) The Controls are selected on the basis of set popularity in your area.
 - (3) You get FREE a metal storage cabinet when you buy this deal.
- Ask your Mallory Distributor or write P. O. Box 1558, Indianapolis, Indiana.

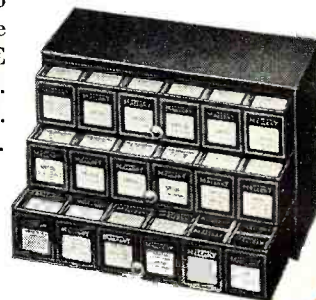

P. R. MALLORY & CO. Inc.
MALLORY

CAPACITORS • CONTROLS • VIBRATORS • SWITCHES • RESISTORS
RECTIFIERS • POWER SUPPLIES • CONVERTERS • MERCURY BATTERIES
APPROVED PRECISION PRODUCTS

P. R. MALLORY & CO. Inc., INDIANAPOLIS 6, INDIANA

Heard
the news?



Centralab

has a
NEW
48-page
catalog

It brings you up to date on the latest developments in America's most complete line of volume controls, switches, capacitors, Printed Electronic Circuits*, and steatite insulators.

Get your
free copy

Tear out the coupon
in the **Centralab**
announcement on
page 21

*Trademark

G-3454

The **ARTSNY STORY**

THE Associated Radio Servicemen of New York, Inc. (ARSNY) was founded in 1947 primarily to fight a bill introduced into the New York City Council calling for the licensing of radio service technicians. The first hectic meetings of the group provided a membership of approximately three-hundred technicians. An organization was formed and immediately requested and received free radio time to answer the charges of incompetence and fraud hurled at the legitimate radio service technicians by public figures. ARSNY was so effective in combating this bad publicity that the bill was shelved, and the hard-working legitimate service technicians in New York City received recognition. After this initial success, the membership realized that they had created a potent organization for promoting their mutual welfare, and they decided to embark on a permanent program of mutual aid. This included an apprenticeship program whereby students worked with ARSNY members to receive practical experience so as to assure a steady supply of competent service technicians. Also, frequent lectures on servicing were arranged and business-building methods were discussed.

The introduction of commercial television brought many new people into the trade and increased the demands upon the technician's knowledge. What had been a more or less stable business suddenly expanded to huge proportions. The rapid sale of a high-priced commodity, serviceable by a limited number of available technicians, offered a tremendous profit potential to those in the field. To meet this challenge, the association (now ARTSNY) organized regular technical lectures to help train its members in TV circuitry and fast methods of servicing. But, the needs of the membership became more and more complicated as business grew and the individual members found it necessary to specialize in either the business or technical aspects of servicing. To solve the problem of how to serve each member more effectively, ARTSNY divided its total membership into two chapters—a business chapter and a technical chapter.

Each of these chapters is headed by a chairman who is also a vice-president of ARTSNY. Each chapter has its own roster of officers and holds its own meetings at the common clubhouse. The business chapter holds meetings the second and fourth Thursdays of each month, at which time there are talks on business methods, advertising, licensing, and other topics of interest to the men who operate their own service businesses. The technical chapter, which meets on the first and third

Thursdays of each month, presents technical lectures by field service engineers of TV receiver manufacturers and other well-known speakers. The attendance at these meetings is limited to active technicians but, of course, many service shop operators also attend the technical meetings since they, too, are service technicians, and *vice versa*.

In addition to the preceding program, ARTSNY sponsors a TV clinic at its clubhouse. Here, at its workbench every Wednesday evening, members bring in their problem chassis (those sets which have proven particularly difficult to service), and in the common give-and-take with other technicians, under the supervision of a field service engineer, these sets are serviced, and valuable training is obtained by all concerned.

At the present stage of the organization, ARTSNY has about five-hundred members, approximately one-half of whom own their own businesses. To become a member, a technician must have at least four years of full-time practical experience in the maintenance and repair of radio and television equipment, as well as pass a practical and theoretical examination on servicing. Also, all members must subscribe to the code of ethics of ARTSNY.

Recently, the *National Broadcasting Company* began a publicity program to acquaint the people of New York City with the advantages of using legitimate service technicians for maintaining their radios and television sets. To this end, WNBC, the radio outlet and WNBT, the television station, are presenting spot announcements valued at approximately \$60,000 a month, informing their listeners and viewers of the existence of ARTSNY, and the advantages to be gained by using ARTSNY members. During these announcements, a telephone number is given for ARTSNY and, at the clubhouse, a full-time paid employee handles all calls for service and routes each request to the ARTSNY member closest to the potential customer. The association also publishes a monthly bulletin, "ARTSNY News."

Realizing that a good public relations program will go far toward obtaining acceptance of its services by the public, ARTSNY has sponsored many helpful causes. One is a program to repair, at no charge, defective TV sets donated by the public for hospitals and institutions. The association also has a grievance committee to expedite complaints by customers against service technicians. All complaints are investigated and, if fraud is suspected, ARTSNY assists in pressing charges.

-30-

RADIO & TELEVISION NEWS

"...and all I did was install a
WALSCO antenna"

Buyers are getting wiser. The quality of *their* TV reception is *your* responsibility . . . and they'll hold you to it! For *your* protection, sell and install

WALSCO, the finest antennas ever built for VHF and UHF.

WALSCO IMPERIAL CONICAL (all-channel VHF)

Featuring the new, exclusive "Barrier Disc" Insulator to prevent shorts and maintain lasting high gain performance anywhere. Designed for color as well as black and white. Not affected by dirt, moisture, salt . . . will not rust. Stainless steel hardware prevents corrosion losses permanently. Pre-assembled . . . guaranteed 3 years!

Single Bay . . . only \$9.95 List. Also available in Dual and 4 Bay Stacks.

WALSCO CORNER REFLECTOR (UHF)

No other UHF antenna so effectively combines all three . . . (1) extra high gain; (2) all-channel reception; (3) sharp vertical and horizontal directivity. Features the hollow, unbreakable X-77 Insulator . . . silicone treated to shed dirt and moisture . . . not affected by extreme heat, cold or wind.

Single Bay . . . \$10.95 List. Also available in 2 and 4 Bay Stacks.



3602 Crenshaw Boulevard, Los Angeles 36, California
 Overseas Distributor: Ad Auriema, Inc., 89 Broad St., New York 4, N.Y.

Branch: 315 West Walton, Chicago, Illinois

Canadian Factory Distributor: Atlas Radio Corp., Ltd., 560 King St. West, Toronto 2-B.



you're on easy street
with **PHOTOFACT**

**TUBE PLACEMENT and
TUBE FAILURE CHECK CHARTS**

TUBE PLACEMENT CHARTS: included in each and every PHOTOFACT TV Folder. Shows top and bottom views; top view is positioned as chassis would be viewed in customer's home. Shows tube locating key or blank pin; gives tube function, type and placement; includes fuse type, location and circuit protected.

TUBE FAILURE CHECK CHART: in each and every PHOTOFACT TV Folder. Shows common trouble symptoms and lists tubes whose failure may be responsible for each type of trouble. Includes schematics of series filament strings for quicker reference.

TUBE FAILURE CHECK CHART

22 other exclusive features consistently in every PHOTOFACT Folder—the world's best data for faster, more profitable servicing...

No. 101, 66A, 66B, 66C, 66D, 66E, 66F, 66G, 66H, 66I, 66J, 66K, 66L, 66M, 66N, 66O, 66P, 66Q, 66R, 66S, 66T, 66U, 66V, 66W, 66X, 66Y, 66Z, 66AA, 66AB, 66AC, 66AD, 66AE, 66AF, 66AG, 66AH, 66AI, 66AJ, 66AK, 66AL, 66AM, 66AN, 66AO, 66AP, 66AQ, 66AR, 66AS, 66AT, 66AU, 66AV, 66AW, 66AX, 66AY, 66AZ, 66BA, 66BB, 66BC, 66BD, 66BE, 66BF, 66BG, 66BH, 66BI, 66BJ, 66BK, 66BL, 66BM, 66BN, 66BO, 66BP, 66BQ, 66BR, 66BS, 66BT, 66BU, 66BV, 66BW, 66BX, 66BY, 66BZ, 66CA, 66CB, 66CC, 66CD, 66CE, 66CF, 66CG, 66CH, 66CI, 66CJ, 66CK, 66CL, 66CM, 66CN, 66CO, 66CP, 66CQ, 66CR, 66CS, 66CT, 66CU, 66CV, 66CW, 66CX, 66CY, 66CZ, 66DA, 66DB, 66DC, 66DD, 66DE, 66DF, 66DG, 66DH, 66DI, 66DJ, 66DK, 66DL, 66DM, 66DN, 66DO, 66DP, 66DQ, 66DR, 66DS, 66DT, 66DU, 66DV, 66DW, 66DX, 66DY, 66DZ, 66EA, 66EB, 66EC, 66ED, 66EE, 66EF, 66EG, 66EH, 66EI, 66EJ, 66EK, 66EL, 66EM, 66EN, 66EO, 66EP, 66EQ, 66ER, 66ES, 66ET, 66EU, 66EV, 66EW, 66EX, 66EY, 66EZ, 66FA, 66FB, 66FC, 66FD, 66FE, 66FF, 66FG, 66FH, 66FI, 66FJ, 66FK, 66FL, 66FM, 66FN, 66FO, 66FP, 66FQ, 66FR, 66FS, 66FT, 66FU, 66FV, 66FW, 66FX, 66FY, 66FZ, 66GA, 66GB, 66GC, 66GD, 66GE, 66GF, 66GG, 66GH, 66GI, 66GJ, 66GK, 66GL, 66GM, 66GN, 66GO, 66GP, 66GQ, 66GR, 66GS, 66GT, 66GU, 66GV, 66GW, 66GX, 66GY, 66GZ, 66HA, 66HB, 66HC, 66HD, 66HE, 66HF, 66HG, 66HH, 66HI, 66HJ, 66HK, 66HL, 66HM, 66HN, 66HO, 66HP, 66HQ, 66HR, 66HS, 66HT, 66HU, 66HV, 66HW, 66HX, 66HY, 66HZ, 66IA, 66IB, 66IC, 66ID, 66IE, 66IF, 66IG, 66IH, 66II, 66IJ, 66IK, 66IL, 66IM, 66IN, 66IO, 66IP, 66IQ, 66IR, 66IS, 66IT, 66IU, 66IV, 66IW, 66IX, 66IY, 66IZ, 66JA, 66JB, 66JC, 66JD, 66JE, 66JF, 66JG, 66JH, 66JI, 66JJ, 66JK, 66JL, 66JM, 66JN, 66JO, 66JP, 66JQ, 66JR, 66JS, 66JT, 66JU, 66JV, 66JW, 66JX, 66JY, 66JZ, 66KA, 66KB, 66KC, 66KD, 66KE, 66KF, 66KG, 66KH, 66KI, 66KJ, 66KK, 66KL, 66KM, 66KN, 66KO, 66KP, 66KQ, 66KR, 66KS, 66KT, 66KU, 66KV, 66KW, 66KX, 66KY, 66KZ, 66LA, 66LB, 66LC, 66LD, 66LE, 66LF, 66LG, 66LH, 66LI, 66LJ, 66LK, 66LL, 66LM, 66LN, 66LO, 66LP, 66LQ, 66LR, 66LS, 66LT, 66LU, 66LV, 66LW, 66LX, 66LY, 66LZ, 66MA, 66MB, 66MC, 66MD, 66ME, 66MF, 66MG, 66MH, 66MI, 66MJ, 66MK, 66ML, 66MN, 66MO, 66MP, 66MQ, 66MR, 66MS, 66MT, 66MU, 66MV, 66MW, 66MX, 66MY, 66MZ, 66NA, 66NB, 66NC, 66ND, 66NE, 66NF, 66NG, 66NH, 66NI, 66NJ, 66NK, 66NL, 66NM, 66NO, 66NP, 66NQ, 66NR, 66NS, 66NT, 66NU, 66NV, 66NW, 66NX, 66NY, 66NZ, 66OA, 66OB, 66OC, 66OD, 66OE, 66OF, 66OG, 66OH, 66OI, 66OJ, 66OK, 66OL, 66OM, 66ON, 66OO, 66OP, 66OQ, 66OR, 66OS, 66OT, 66OU, 66OV, 66OW, 66OX, 66OY, 66OZ, 66PA, 66PB, 66PC, 66PD, 66PE, 66PF, 66PG, 66PH, 66PI, 66PJ, 66PK, 66PL, 66PM, 66PN, 66PO, 66PP, 66PQ, 66PR, 66PS, 66PT, 66PU, 66PV, 66PW, 66PX, 66PY, 66PZ, 66QA, 66QB, 66QC, 66QD, 66QE, 66QF, 66QG, 66QH, 66QI, 66QJ, 66QK, 66QL, 66QM, 66QN, 66QO, 66QP, 66QQ, 66QR, 66QS, 66QT, 66QU, 66QV, 66QW, 66QX, 66QY, 66QZ, 66RA, 66RB, 66RC, 66RD, 66RE, 66RF, 66RG, 66RH, 66RI, 66RJ, 66RK, 66RL, 66RM, 66RN, 66RO, 66RP, 66RQ, 66RR, 66RS, 66RT, 66RU, 66RV, 66RW, 66RX, 66RY, 66RZ, 66SA, 66SB, 66SC, 66SD, 66SE, 66SF, 66SG, 66SH, 66SI, 66SJ, 66SK, 66SL, 66SM, 66SN, 66SO, 66SP, 66SQ, 66SR, 66SS, 66ST, 66SU, 66SV, 66SW, 66SX, 66SY, 66SZ, 66TA, 66TB, 66TC, 66TD, 66TE, 66TF, 66TG, 66TH, 66TI, 66TJ, 66TK, 66TL, 66TM, 66TN, 66TO, 66TP, 66TQ, 66TR, 66TS, 66TT, 66TU, 66TV, 66TW, 66TX, 66TY, 66TZ, 66UA, 66UB, 66UC, 66UD, 66UE, 66UF, 66UG, 66UH, 66UI, 66UJ, 66UK, 66UL, 66UM, 66UN, 66UO, 66UP, 66UQ, 66UR, 66US, 66UT, 66UU, 66UV, 66UW, 66UX, 66UY, 66UZ, 66VA, 66VB, 66VC, 66VD, 66VE, 66VF, 66VG, 66VH, 66VI, 66VJ, 66VK, 66VL, 66VM, 66VN, 66VO, 66VP, 66VQ, 66VR, 66VS, 66VT, 66VU, 66VV, 66VW, 66VX, 66VY, 66VZ, 66WA, 66WB, 66WC, 66WD, 66WE, 66WF, 66WG, 66WH, 66WI, 66WJ, 66WK, 66WL, 66WM, 66WN, 66WO, 66WP, 66WQ, 66WR, 66WS, 66WT, 66WU, 66WV, 66WW, 66WX, 66WY, 66WZ, 66XA, 66XB, 66XC, 66XD, 66XE, 66XF, 66XG, 66XH, 66XI, 66XJ, 66XK, 66XL, 66XM, 66XN, 66XO, 66XP, 66XQ, 66XR, 66XS, 66XT, 66XU, 66XV, 66XW, 66XX, 66XY, 66XZ, 66YA, 66YB, 66YC, 66YD, 66YE, 66YF, 66YG, 66YH, 66YI, 66YJ, 66YK, 66YL, 66YM, 66YN, 66YO, 66YP, 66YQ, 66YR, 66YS, 66YT, 66YU, 66YV, 66YW, 66YX, 66YY, 66YZ, 66ZA, 66ZB, 66ZC, 66ZD, 66ZE, 66ZF, 66ZG, 66ZH, 66ZI, 66ZJ, 66ZK, 66ZL, 66ZM, 66ZN, 66ZO, 66ZP, 66ZQ, 66ZR, 66ZS, 66ZT, 66ZU, 66ZV, 66ZW, 66ZX, 66ZY, 66ZZ

NOW! GET THE PROOF FOR YOURSELF!

FREE

We'll send you a Free Photofact TV Folder—just ask us for it!

Learn for yourself how PHOTOFACT pays for itself by earning bigger profits for you! We'll send you the proof—a FREE specimen PHOTOFACT TV Folder that shows all the features found consistently and exclusively ONLY in PHOTOFACT. Send for your FREE specimen TV Folder now. Examine it. Compare it. You'll see why PHOTOFACT belongs in your shop! And you'll want to ask your parts distributor about the pay-as-you-earn-plan. Only \$25 down brings you the entire PHOTOFACT Library. Write for FREE specimen TV Folder—learn now how to earn more!

HOWARD W. SAMS & CO., INC.
2203 E. 46th St., Indianapolis 5, Ind.

HOWARD W. SAMS & CO., INC.

SAVE THAT RECTIFIER

By JOHN P. FATH

Don't throw away those 27½ volt 35Z5GT's! They can be used in this low-voltage a.c.-d.c. power supply.

A LOW-VOLTAGE a.c.-d.c. power supply is a very useful piece of equipment to have around the shack whether you're a radio and TV technician, home experimenter, or a ham. Despite the ever-faithful "junk box" which all shacks possess there is always the cost of the rectifier tube to take a small nip out of the wallet. If you should choose a rectifier which requires a series heater dropping resistor—you then have another addition to the initial cost. Should you choose the 117-volt heater type you can expect an early replacement since these tubes are notorious for their heater burnout problems. Why buy a rectifier for these power supplies when in all likelihood you've been throwing away perfectly good rectifiers? Use "27½" Z5GT rectifiers in your supply.

It is well known that the major cause of rectifier failure in a.c.-d.c. radios using the 35Z5GT is a burnout of the pilot lamp section of the heater. A quick look at a tube manual will show that approximately four-fifths of the heater is still good and will heat the cathode sufficiently for completely satisfactory service.

The heater is divided into the panel lamp section, which is rated at 7½ volts with no panel lamp shunting it, and the main section rated at 27½ volts (35 volts minus 7½ volts). It is an easy task then to build a half-wave power supply using a series-dropping resistor to obtain the required 27½ volts at 0.15 ampere. The writer has employed such an arrangement in an "intercom" unit using a 50L6GT and a 12SQ7GT in series with the "27½" Z5GT and a 160-ohm line cord. The unit has been in service for seven years now and has never had a tube replacement.

After saving four of these "lame" 35Z5GT tubes it becomes unnecessary to obtain a series current-limiting resistor because it is a simple matter to wire the tube heaters in series to obtain full use of the line voltage and also to gain the advantages of bridge rectification. It

is possible to obtain the full current capability of the 35Z5GT in these circuits, i.e., 100 milliamperes. The fact that the cathode is not up to design temperature is of no consequence as the copious supply and zero cost will completely overshadow the replacement problem.

The circuit of Fig. 1 shows a bridge rectifier which provides either positive or negative voltage with respect to ground by the simple expedient of connecting the "minus" terminal to the ground post for the former polarity or connecting the "plus" terminal to the ground post for the latter polarity. The circuit can be "dressed up" by adding a 117-volt pilot lamp, a fuse, and a "plate" switch, as indicated by the dotted lines. Note that the "plate" switch is on the load side of the power supply instead of directly in the plate lead of the rectifiers. This is recommended because of the large value of the input condenser. The instantaneous impedance of the filter system is zero ohms at the instant that the power is applied to the plates (assuming the cathodes are already up to operating temperature) causing excessive current to flow through the rectifiers and seriously damaging the cathodes. By placing this switch in the load side of the power supply we overcome this problem since the filter condensers are fully charged at all times. Without the "plate" switch, the aforementioned condition never obtains as the cathodes come up to temperature so slowly that the rectifier internal resistance limits this "surge" current to low values until the condensers are fully charged and the cathodes are up to temperature.

When operating the power supply with one side of the output grounded it is important to remember that the chassis can be operating at or near line potential through the rectifiers and therefore constitutes a safety hazard unless a line-isolating transformer is employed by the operator.

Fig. 1. Schematic of bridge rectifier using "lame" 35Z5GT rectifiers. See text.

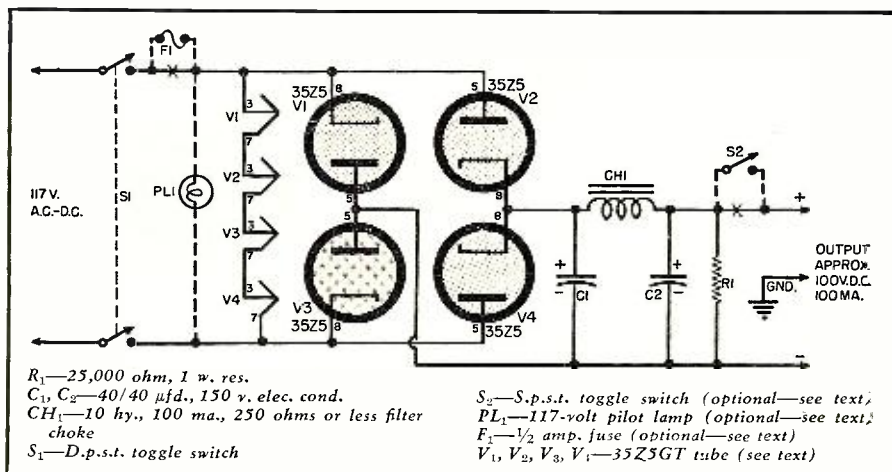

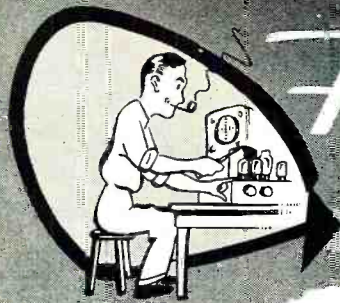

BUILD YOUR OWN

Heathkits

- TEST INSTRUMENTS
- AMPLIFIERS
- RECEIVERS, etc.

- ① Save by ordering direct from manufacturer.
- ② All high quality standard brand components.
- ③ Increased knowledge through actual construction.
- ④ Sound engineering insures excellent performance.
- ⑤ Kit construction is fascinating and enjoyable.



MODEL O-9
\$59.50
Shipping Wt. 28 lbs.

Heathkit MODEL O-9 OSCILLOSCOPE KIT

New features unheard of in a kit oscilloscope have been added to the already popular Heathkit series. All top quality components are used including a brand new RCA 5UP1 CRT. Ten other first line tubes complete the lineup. Voltage regulation provides a rock steady pattern regardless of normal line voltage variations. A built-in blanking amplifier eliminates the retrace line entirely. Other important advantages are a phasing control, Z axis input, direct connections to the deflection plates, 1 volt peak-to-peak calibration voltage and a calibrated grid screen.

Wiring is simplified by the use of the harness technique which also results in a neat professional appearance. Extremely wide vertical bandwidth allows accurate reproduction of even a 500 KC square wave. Excellent focusing characteristics are made possible by the use of the new RCA 5UP1 CRT and a spot shape control. One of the most versatile of test instruments, the Heathkit O-9 Oscilloscope will be invaluable in the radio and TV service shop, as a work project in schools and for all types of circuit investigation work in the laboratory. Its new features make Model O-9 comparable in every way to many commercially built oscilloscopes selling for as much as \$400. Don't pass up this opportunity to add a really fine instrument to your service or experimental lab.

Heathkit

VOLTAGE CALIBRATOR KIT

The use of a Voltage Calibrator will greatly increase oscilloscope usefulness. Provides a convenient method of making peak to peak voltage measurements by establishing a relationship between the unknown wave shape and the Voltage Calibrator. Voltage ranges .01-100 volts peak to peak. The Voltage Calibrator features direct reading scales and a regulated power supply system.



MODEL VC-2
\$11.50
Shipping Wt. 4 lbs.

Heathkit

ELECTRONIC SWITCH KIT

The Heathkit Electronic Switch Kit will further extend scope usefulness by permitting simultaneous observation of two individually controlled traces. Continuously variable switching rates 10 cps to 2,000 cps in three ranges. Will also serve as a square wave generator over the range of switching frequencies.



MODEL S-2
\$23.50
Shipping Wt. 11 lbs.

Heathkit VACUUM TUBE VOLTMETER KIT

The beautiful new 1953 Heathkit Model V-6 VTVM, the world's most popular kit instrument, now offers many outstanding new features in addition to retaining all of the refinements developed and proven through the production of over 70,000 VTVM kits. The Heathkit VTVM now features extended voltage ranges with 50% greater coverage on the DC range. New 1 1/2 volt low scale provides well over 2 1/2 inches of scale length per volt permitting faster measurements with greater accuracy. AC and DC ranges are 0-1.5-5-15-50-150-500-1500 volts (1,000 volts maximum on AC). Ohmmeter ranges are X1, X10, X100, X1,000, X10K, X100K X1 meg. Measures .1 ohm to 1,000 megohms. Other features are db scale, center scale zero adjust and polarity reversal switch. High 11 megohm input resistance virtually eliminates circuit loading.

The low anti-inflation price of this tremendously popular kit includes all tubes, necessary constructional material, test leads and the construction manual.

MODEL V-6
\$24.50
Shipping Wt. 6 lbs.

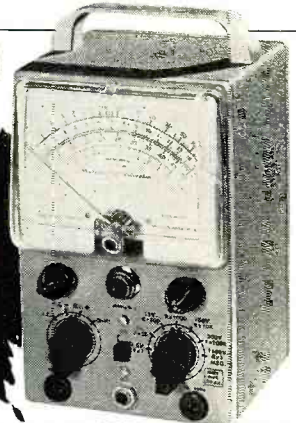

Heathkit AC VACUUM TUBE VOLTMETER KIT



MODEL AV-2
\$29.50
Shipping Wt. 5 lbs.

A new amplifier type AC VTVM that makes possible those sensitive measurements so essential in laboratory or audio work. Ten voltage ranges covering from .01 RMS full scale to 300 volts RMS full scale. Input impedance 1 megohm with frequency response 20-50,000 cycles. Ten DB ranges from -52 to +52 DB. Four diodes in meter bridge circuit for maximum linearity.

Heathkit

HANDITESTER KIT



MODEL M-1
\$14.50
Shipping Wt. 3 lbs.

The ever popular Handitester is now supplied with a Simpson 400 microampere meter movement. Provides AC and DC voltage ranges 0-10-30-300-1,000-5,000 volts. Ohmmeter ranges 0-3,000 and 0-300,000 ohms. DC current measurements 0-10 and 0-100 milliamperes. A completely self contained portable instrument.

HEATH COMPANY • Benton Harbor 15, Mich.

HEATHKITS for the ENGINEER

Heathkit VISUAL AURAL SIGNAL TRACER KIT

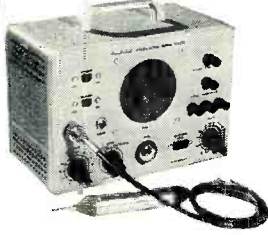

MODEL T-3 **\$23⁵⁰**

Shipping
Wt. 10 lbs.

Designed especially for service applications in AM-SW-FM-TV repair work. RF and audio two channel inputs. More than adequate sensitivity—new noise locator circuit—calibrated wattmeter—substitution speaker—visual signal indication. Can be used with scope and VTVM, checks phono cartridges, phono mechanisms, microphones, tuners, etc. Let the Heathkit Visual Aural Signal Tracer help you.

Heathkit CONDENSER CHECKER KIT

An instrument designed solely for its particular job. Not a "sideline" or a multiple function instrument. Measures value and quality of unknown condensers and resistors. Capacity range .00001 mfd to 1,000 mfd. Resistance range 100 ohms to 5 megohms. Sensitive electron beam indicator—five polarizing test voltages—safety spring return leakage test switch. An amazingly accurate instrument at this low price.



MODEL C-3
\$19⁵⁰ Shipping
Wt. 8 lbs.

Heathkit SIGNAL GENERATOR KIT



MODEL SG-8
\$19⁵⁰

Shipping Wt. 8 lbs.

The standard service instrument for alignment work. .1 volts output from 160 KC to 110 MC. Calibrated harmonics up to 220 MC. Internal (400 CPS) and external modulation. Pre-calibrated coils for all 5 bands. Good stability and accuracy. All test leads included.

Heathkit GRID DIP METER KIT



MODEL GD-1B
\$19⁵⁰

Shipping Wt. 4 lbs.

One hand operation. 5 pre-wound coils cover 2—250 MC. Controlled sensitivity. Usable as an oscillator or an absorption wavemeter. Extra low frequency coils available.

Heathkit RESISTANCE SUBSTITUTION BOX KIT

MODEL RS-1

Ship. Wt. **\$5⁵⁰**
2 lbs.



Choice of 36 switch selected resistance values 15 ohms to 10 megohms. All standard RTMA 1 watt 10% resistors. Buy several for those lab and service applications.

NEW Heathkit 20,000 OHMS PER VOLT MULTIMETER KIT

Here is the solution to all service problems requiring a portable measuring device of high accuracy. 20,000 ohms/volt sensitivity on DC and 5000 ohms/volt on AC. Full scale voltage ranges of 1.5, 5, 50, 150, 500, 1500 and 5000. DC current ranges of 150 microamperes; 15, 150 and 500 milliamperes; and 15 amperes. Resistances are measured from .2 ohms to 20 megohms in 3 ranges and decibels from -10 to +65 db.

Model MM-1 uses standard commercially available batteries and is not affected by strong RF fields as encountered in and near transmitting equipment. 1% precision resistors on a very easily wired ring type range switch and a highly accurate Simpson 50 microampere meter fully qualifies the Heathkit Multimeter for close tolerance laboratory and service work. The meter movement is placed in a recessed position for maximum non-glare readability. The kit includes the attractive black bakelite cabinet, 2 color meter scales, test leads, batteries and all other necessary components. Overall cabinet size is 5 1/4" wide x 4" deep x 7 1/2" high.

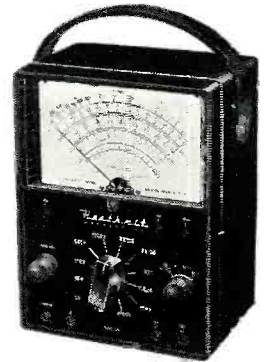

MODEL MM-1
\$26⁵⁰
Ship. Wt. 6 lbs.

Heathkit TUBE CHECKER KIT

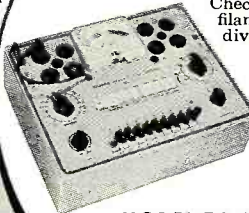

MODEL TC-2
\$29⁵⁰

Shipping Wt. 12 lbs.

Checks overall tube quality, filament continuity, and individual elements for shorts and opens. Features chart illumination, harness type wiring, and large 3-color meter scale.

Portable Model TC-2P at \$34.50. Wt. 14 lbs. No. 91-8 Cabinet only at \$7.50. Wt. 7 lbs. No. 355 TV Picture Tube Adapter at \$4.50. Wt. 1 lb.

Heathkit LABORATORY REGULATED POWER SUPPLY KIT

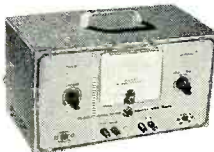

MODEL PS-2
\$33⁵⁰

Shipping Wt. 20 lbs.

A regulated variable 160-450 volt DC output power supply for the lab or service shop. Accurate voltage and current measurements with large Simpson meter. AC supply 6.3 volts at 4 amperes—standby switch eliminates warmup time. Low hum content—5 tube circuit. AC and DC output voltages isolated from panel for maximum operational flexibility.

Heathkit LABORATORY GENERATOR KIT



MODEL LG-1
Ship. Wt. **\$39⁵⁰**
16 lbs.

A professional laboratory instrument designed for extreme accuracy in frequency and output level. Colpitts oscillator operates in 5 ranges from 150 KC to 30 MC. Panel meter calibrated in output voltage and percent of modulation. Output in excess of .1 volts. Features complete shielding of oscillator, buffer and attenuator sections; regulated power supply and 50 ohm output cable. Comparable instruments priced many times higher than the cost of this new kit.

Heathkit AUDIO WATTMETER KIT



MODEL AW-1
Ship. Wt. **\$29⁵⁰**
6 lbs.

Measure output power levels directly with the Heathkit Audio Wattmeter. Flat response to frequencies from 10 CPS to 250 KC. Full scale ranges of 5 MW, 50 MW, 500 MW, 5 W and 50 W. Db calibration from -10 to +48. Uses non-inductive built-in load resistors providing impedances of 4, 8, 16 and 600 ohms. Meter bridge uses 4 germanium diodes.

HEATH COMPANY • Benton Harbor 15, Mich.

SERVICEMAN • AMATEUR • STUDENT

Heathkit IMPEDANCE BRIDGE KIT



MODEL IB-2
\$59⁵⁰

Ship. Wt. 15 lbs.

Modern design with built-in 1 KC generator for AC measurements. A choice of the Wheatstone, Maxwell, Hay or capacitance comparison bridges for measuring resistance, capacitance, inductance, dissipation factor and storage factor. 1/2% resistors and precision mica condensers provide maximum accuracy. Completely AC operated.

Heathkit DECADE RESISTANCE KIT

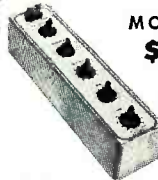

MODEL DR-1
\$19⁵⁰

Ship. Wt.
4 lbs.

Individual switch selection of twenty 1% precision resistors in 1 ohm steps from 1 to 99,999 ohms. Sturdy ceramic wafer switches featuring silver plated contacts and smooth, positive detent action.

Heathkit COMMUNICATIONS RECEIVER KIT



MODEL AR-2
\$25⁵⁰
Ship. Wt. 12 lbs.
(Less Cabinet)

Full coverage from 550 KC to 35 MC on 4 bands, with good sensitivity and selectivity. Features electrical bandspread, BFO, headphone jack, slide rule dial with ham band identification, RF gain control, noise limiter and phone-standby-CW switch. Top quality, high gain components used throughout. Pre-wound coils in a shielded turret assembly and a transformer operated power supply assure trouble-free performance.

Cabinet available separately, No. 91-10, Shipping wt. 5 lbs. Price \$4.50.

Heathkit Q METER KIT

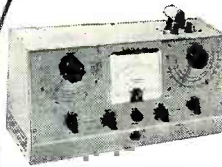

MODEL QM-1
\$44⁵⁰ Ship. Wt. 14 lbs.

A typical Heathkit invasion of the laboratory instrument field. Here is the first successful low priced Q meter ever offered in kit form. Oscillator supplies RF in the range of 150 KC to 18 mc. Reads Q directly on calibrated meter scales. Measures Q of condensers, RF resistance and distributed capacity of coils. Calibrate capacitor with range of 40 mmf to 450 mmf with vernier ±3 mmf. All measurements made at the operating frequency.

Heathkit AUDIO OSCILLATOR KIT

MODEL AO-1
\$24⁵⁰

Ship. Wt. 11 lbs.



Features sine or square wave coverage from 20-20,000 cycles in 3 ranges. Variable 10 volt output level at 600 ohms impedance. Thermistor controlled linearity—precision multiplier resistors—distortion less than .6%. An outstanding instrument value at this amazing low price.

Heathkit AMATEUR TRANSMITTER KIT



MODEL AT-1
\$29⁵⁰

Ship. Wt. 16 lbs.

Power input up to 35 watts on 80, 40, 20, 15, 11 and 10 meters. Can be crystal or VFO excited. Complete with modulator input socket and VFO power output provisions. Other desirable features are good shielding, AC line filter, key click filter, standby switch and a 52 ohm coaxial output. Model AT-1 is AC operated and is suitable as an exciter for a higher powered rig. Complete with full instructions for construction and use.

Heathkit TELEVISION SWEEP GENERATOR KIT

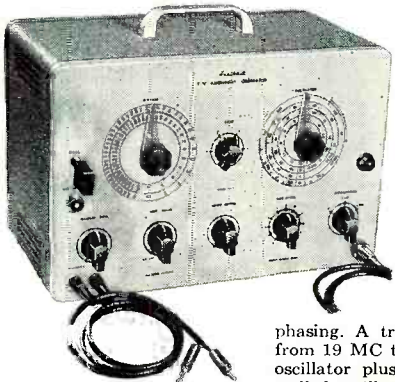

MODEL TS-3
\$44⁵⁰

Ship. Wt. 18 lbs.

Simplify your TV alignment jobs with the new Heathkit TS-3. Full coverage on fundamentals from 4 MC to 220 MC at an output of well over 100,000 microvolts . . . Automatic blanking and wide range phasing. A triple marker system ranges from 19 MC to 180 MC using a Colpitts oscillator plus the 4.5 MC crystal controlled oscillator for check points (crystal furnished). Provisions are also made for using an external marker.

Featured is the new sweep system, using an *INCREDUCTOR controllable inductor. Sweep width is variable from 0 to 12 MC at the lower RF frequencies and increases to 0-50 MC at the highest . . . Other advantages are power supply regulation, constant RF output level, independent marker and RF output control circuits, low impedance output and properly terminated output cables. The construction manual is complete in all detail and with a reasonable amount of care, Model TS-3 will serve faithfully for many years to come.

*Trademark, C.G.S. Laboratories, Stamford, Connecticut

Heathkit DECADE CONDENSER KIT

Switch selected 1% silver mica precision condensers providing capacity range of 100 mmf. to 0.111 mfd. in steps of 100 mmf.

MODEL DC-1
\$16⁵⁰

Shipping Wt. 4 lbs.



Heathkit AUDIO GENERATOR KIT

A new extended range 18 cycles — 1 megacycle audio instrument at a remarkably low price. Five continuously variable output ranges—600 ohm output impedance—low distortion figure, less than .4% from 100 cps through audible range.

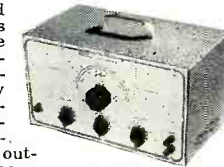

MODEL AG-8
\$29⁵⁰

Ship. Wt. 11 lbs.

Heathkit BAR GENERATOR KIT



Small, compact and easy to use, Model BG-1 supplies horizontal or vertical bars for TV linearity adjustments. Output cable clips directly to the TV receiver antenna terminals.

MODEL BG-1

Ship. Wt. 6 lbs. **\$14⁵⁰**

Heathkit BATTERY ELIMINATOR KIT

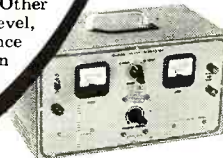

MODEL BE-4
\$31⁵⁰
Ship. Wt. 18 lbs.

6 or 12 volt operation with current and voltage constantly monitored. Double protection with a fused transformer and automatic overload relay. Well filtered output and all heavy duty components. Designed for auto radio repair and as a storage battery charger.

WRITE FOR Free CATALOG

New 40 page 1954 Catalog lists all kits, specifications, schematics and latest price information.

HEATH COMPANY • Benton Harbor 15, Mich.

Basic Color TV
(Continued from page 62)

appropriate points in the matrix network.

The remainder of the chrominance channel consists of three individual 6CL6 amplifiers, one for each of the three color signals, and three d.c. restorers. Action here is similar to that existing at the same point in the previous system and additional explanation is not required.

There are many ways of handling the color signals and the chrominance circuits of one manufacturer would differ in some respect from those of his competitors. Figs. 2 and 5 illustrate two possible approaches. Still another is shown in Fig. 6 and it contains several interesting features. The color signal is received from the first video amplifier by a bandpass amplifier. The chroma control is contained in the cathode of this stage and as much signal as desired is tapped off here and transferred to a second bandpass amplifier via a 1N34 crystal. The purpose of the germanium crystal is closely linked to the negative triggering pulses which are fed into the circuit via R_1 and L_1 . The negative pulses appear during the horizontal retrace interval when the color burst is passing through the circuit. The arrival of the pulse

prevents the 1N34 from conducting since the pulse amplitude is greater than that of the color burst coming from V_1 and, consequently, the color burst is effectively prevented from continuing farther into the chrominance section. At all other times, the signal polarity is such that the 1N34 conducts and so whatever voltage is present across the chroma control reaches the grid of V_2 . This, then, is the way this circuit removes the color burst from the chrominance channel.

The bandpass of V_1 and V_2 extends from 2.1 mc. to 4.8 mc. and the signals within this range are amplified and then transferred to a 6J6 cathode follower (V_3).

The next recipients of the color signal are the I and Q demodulators. The signal is fed in equal measure to grid No. 1 of both 6AS6's. At the same time, grid No. 3 of each tube receives a 3.58-mc. subcarrier voltage. The peak-to-peak value of this signal is on the order of 18 volts and the only difference between the 3.58-mc. voltages is a 90° phase difference.

In the I section, the demodulator is followed by an amplifier and then a phase splitter. The latter tube makes positive and negative I voltages available to the matrix. Bandpass of the I section is 1.3 mc.

In the companion Q section, the demodulator is followed by a single phase splitter which provides positive and

Fig. 6. Chrominance circuit containing a manual color killer switch and a 1N34 crystal circuit for eliminating the color burst signal from the chrominance channel.

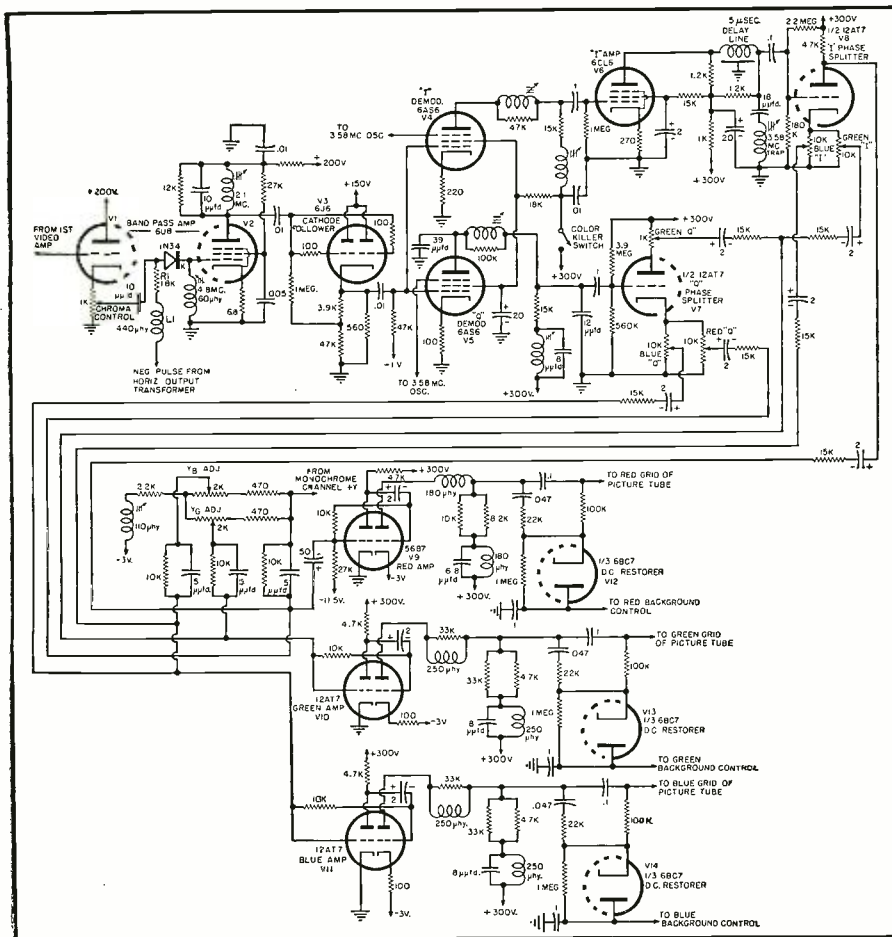

Wait'll you see what

Centralab

has up its sleeve!

It's the most important development in years in dual concentric controls!

Watch for early

Centralab

announcement in this magazine

NEW INVENTION OUTMODES ALL PRESENT ANTENNAS!

53 CLAIMS GRANTED IN 5 U.S. PATENTS ON NEW REVOLUTIONARY ANTENNA INVENTION!

NEW!

SUPER 60

#2,585,670 #2,609,503 #2,625,655 #2,644,091 #2,661,423 others pending



COMPLETELY REVOLUTIONARY

LIST PRICE
\$36.75
SEE YOUR
JOBBER

The 9-position selector switch electronically rotates the antenna in a stationary position.



NEW POLYMICALENE
4 CONDUCTOR TRANSMISSION LINE

THIS IS ALL YOU NEED!

The price includes the complete antenna and the 9-position electronic orientation switch. The Air Dielectric Polymicalene Transmission Line is purchased as required for the individual installation.

If your Distributor or Dealer can't supply you... Contact us for the name of one who can

★ GUARANTEED TO POSITIVELY OUTPERFORM ALL OTHER ANTENNAS (with or without rotor motors) on ALL UHF, and ALL VHF stations 2 thru 83 from ALL directions.

★ GUARANTEED to positively give you the **CLEAREST, SHARPEST, most PERFECT GHOST-FREE** pictures possible in both **COLOR** and **black-white**.

MONEY BACK GUARANTEED TO RECEIVE ALL CHANNELS 2-83 FROM ALL DIRECTIONS AND POSITIVELY OUTPERFORM ALL OTHER ANTENNAS WITH OR WITHOUT A ROTORMOTOR

UP TO 10 TIMES MORE POWERFUL THAN ALL PRESENT CONVENTIONAL ANTENNAS!

New, revolutionary antenna, while being up to 10 times more powerful than conventional antennas, is still able to receive all television and FM stations from all directions without a rotor motor of any kind. The electronic orientation switch used with a new type transmission line developed specifically for this extra powerful antenna now makes it possible to clearly receive stations heretofore considered out of range. It is now possible to put up just one antenna, use just one transmission line, pay for just one installation and receive the finest possible reception from the stations in and coming to your area regardless of their direction.

ONCE AND FOR ALL SOLVE YOUR ANTENNA PROBLEM

ALL CHANNEL ANTENNA CORP.

47-39 49th STREET, WOODSIDE 77, N. Y.

EXETER 2-1336

CORONA RADIO KITS

EASY TO BUILD • EDUCATIONAL EXCELLENT RECEPTION

Broadcast Superhet Kit

\$14.75

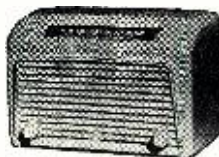

ROCKET 115K—Latest Single Band superhet circuit for ultimate in sensitive reception and tonal quality. Kit includes all necessary parts, punched chassis, attractive bakelite mahogany cabinet, built-in loop antenna, iron core IFs, big Alnico V spkr.; tubes: 12SK7, 12SA7, 12SQ7 50L6, 3Z5. Automatic vol. control, beam power output. Tunes 340 to 1700 Kc. Simple step-by-step instructions included.

Plaza 812K 2-Band AC-DC Super Kit...net \$20.75
Globemaster 814K 3-Band Super Kit...net \$24.75
All kits supplied less wire and solder. Please include 25% deposit with C.O.D. orders. Dept. N-7

CORONA RADIO & TV CO.
138 LIBERTY ST., NEW YORK 6, N. Y.

TV TRADE-IN SETS

• Philco • Emerson • GE • Admiral
• Motorola • Tele-King • Others
10"—\$17; 12" to 17"—\$20 up

Send check or money order now!
List available—Add \$5 each for packing
WASHTEK SERVICE CO.
1501 Boston Road, Bronx, N. Y. DA 3-9281

CODE SENDING SPEED

Be a "key" man. Learn how to send and receive messages in code by telegraph and radio. Commerce needs thousands of men for jobs. Good pay, adventure, interesting work. Learn at home quickly through famous Candler System. Qualify for Amateur or Commercial License. Write for FREE BOOK.
CANDLER SYSTEM CO.
Dept. 2H, Box 928, Denver 1, Colo., U.S.A.

negative Q signal voltages for the matrix. The bandpass of this section extends to .5 mc. in accordance with the nature of the received signal. It is interesting to note that should the bandpass of this channel be broadened above .5 mc., color infidelity would occur because of the presence of some higher frequency I signals in the Q channel. When the bandpass is limited to .5 mc., these "spurious" I signals are attenuated below the point of visibility and do no damage. But if the cut-off were extended, they would reach the picture tube and cause color "distortion."

There are several features worthy of special mention in the I and Q stages of Fig. 6. The "B+" voltage for the screen grids of V₁ and V₂ may be cut off by a manual switch called the "color killer" switch. When a black-and-white broadcast is being received, this switch is turned to the off position, disabling both demodulators and preventing any spurious signals from passing through the color section. For a color broadcast, the switch is turned back on again. This is a simple (and economical) form of color killer circuit. However, it does possess the disadvantage of requiring the set user to know when a color transmission is being received, otherwise all he will get will be black-and-white pictures. In the two previous systems, the color killer network functioned automatically; when a color signal was received, the killer voltage was automatically removed and a color picture appeared on the screen.

Another feature of Fig. 6 worth noting is the use of an actual delay line in the I section. In the other systems, the delay was distributed throughout the I system.

The voltages which the I and Q phase splitters apply to the matrix are nearly all individually adjustable. In this respect it is of interest to note the names applied to these controls. In the I phase splitter, there is a "Green I" and a "Blue I" adjustment. The "Green I" control is so named because the voltage from this point goes to the green amplifier stage and variation of this voltage would affect the hue of the green seen on the screen. The same type of reasoning applies to the "Blue I" adjustment since the voltage from this control goes to the blue amplifier stage. Three similar controls are employed in the Q phase splitter.

Finally, there are two adjustments near the point where the brightness signal enters the matrix. These are labeled as Y_B and Y_G adjustments and they control the amount of Y signal fed into the blue and green amplifier stages via the matrix. Definite relationships exist among the I, Q, and Y voltages and these relationships must be carefully observed if the proper hue, brightness, and saturation are to be obtained on the screen. By making a number of controls available, the service technician can make whatever compensating adjustments may be required to achieve the proper color rendition. (To be continued)

RADIO & TELEVISION NEWS

FREE

MONEY MAKING
FCC
 Commercial-Radio Operator
LICENSE
 INFORMATION

TELLS HOW -

WE GUARANTEE

TO TRAIN AND COACH YOU AT HOME IN SPARE TIME UNTIL YOU GET

YOUR FCC LICENSE

If you have had any practical experience—Amateur, Army, Navy, radio repair, or experimenting.

Here is your guarantee

If you fail to pass your Commercial License exam after completing our course, we guarantee to continue your training without additional cost of any kind, until you successfully obtain your Commercial license, provided you first sit for this examination within 90 days after completing your course.

TV Engineering

INCLUDED IN OUR TRAINING AND COACHING

TELLS HOW -

OUR AMAZINGLY EFFECTIVE JOB-FINDING SERVICE HELPS CIRE STUDENTS GET BETTER JOBS. HERE ARE JUST A FEW RECENT EXAMPLES OF JOB-FINDING RESULTS:

GETS CIVIL SERVICE JOB

"Thanks to your course I obtained my 2nd phone license, and am now employed by Civil Service at Great Lakes Naval Training Station as an Equipment Specialist."
 Kenneth R. Leiser, Fair Oaks, Mtd. Del., McHenry, Ill.

GETS STATE POLICE JOB

"I have obtained my 1st class ticket (thanks to your school) and since receiving same I have held good jobs at all times. I am now Chief Radio Operator with the Kentucky State Police."
 Edwin Healy, 264 E. 3rd St., London, Ky.

GETS BROADCAST JOB

"I wish to thank your Job-Finding Service for the help in securing for me the position of transmitter operator here at WCAE, in Pittsburgh."
 Walter Koschik, 1442 Ridge Ave., N. Braddock, Pa.

GETS AIRLINES JOB

"Due to your Job-Finding Service, I have been getting many offers from all over the country, and I have taken a job with Capital Airlines in Chicago, as a Radio Mechanic."
 Harry Clare, 4537 S. Drexel Blvd., Chicago, Ill.

HERE'S PROOF FCC LICENSES ARE OFTEN SECURED IN A FEW HOURS OF STUDY WITH OUR COACHING AT HOME IN SPARE TIME:

Name and Address	License	Lessons
Lee Worthy, 2210 1/2 Wilshire St., Bakersfield, Cal.	2nd Phone	16
Clifford E. Vogt, Box 1016, Dania, Fla.	1st Phone	20
Francis X. Foerch, 38 Beucler Pl., Bergenfield, N. J.	1st Phone	38
S/Sgt. Ben H. Davis, 317 North Roosevelt, Lebanon, Ill.	1st Phone	28
Albert Schaell, 110 West 11th St., Escondido, Cal.	2nd Phone	23

CARL E. SMITH, E.E. Consulting Engineer, President

CLEVELAND INSTITUTE OF RADIO ELECTRONICS

Desk RN-66, 4900 Euclid Bldg., Cleveland 3, Ohio

July, 1954

TELLS HOW -

EMPLOYERS MAKE JOB OFFERS LIKE THESE TO OUR GRADUATES EVERY MONTH!

Letter from nationally-known Airlines, "We would also appreciate if you would place the following additional advertisement in your bulletin—Wanted—Superintendent of Communications . . . Salary \$666.66 per month."

Letter from nationally known airplane manufacturer, "We need men with electronic training or experience in radar maintenance to perform operational check-out of radar and other electronics systems . . . starting salary . . . amounting to \$329.33 per month."

Letter from nationally-known Airlines, "We are contemplating placing . . . an Airline Ground Radio Engineer." Starting salary \$385 per month.

These are just a few of the examples of the job offers that come to our office periodically. Some licensed radioman filled each of these jobs; it might have been you!

Ours is the only home study course which supplies FCC-type examinations with all lessons and final tests.

ACT NOW!

Get ALL 3 FREE

Your FCC Ticket is required by most employers as proof of your technical ability.

MAIL COUPON NOW!



Cleveland Institute of Radio Electronics
 Desk RN-66—4900 Euclid Bldg., Cleveland 3, Ohio
 (Address to Desk No. to avoid delay)

B I want to know how I can get my FCC Ticket in a minimum of time. Send me your FREE booklet, "How to Pass FCC License Examinations" (does not cover exams for Amateur License), as well as a sample FCC-type exam and the amazing new booklet, "Money-Making FCC License Information."

Be sure to tell me about your Television Engineering Course.

Name

Address

City Zone State

Paste on 2 cent postcard or send air mail.

CANNON Sub-Miniature PLUGS

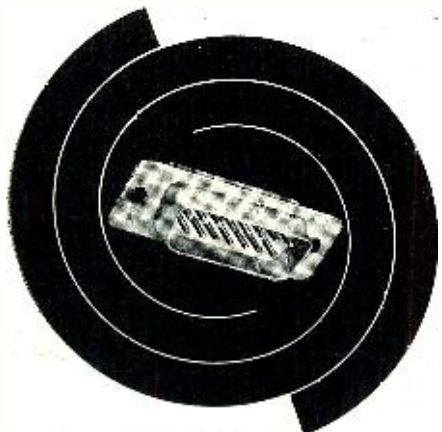

TYPE "D" . . . UP TO 50 CONTACTS

For Your Miniaturization Program!

Save space . . . save weight . . . rugged. 1000's of uses! Pressed steel shells. Heavily gold-plated copper-alloy 5-amp. contacts give untarnishing high surface conductivity and corrosion resistance. Take #20 solder-tipped wires. Polarization means. Salt-spray resistant shells. Flashover 1700v dc.

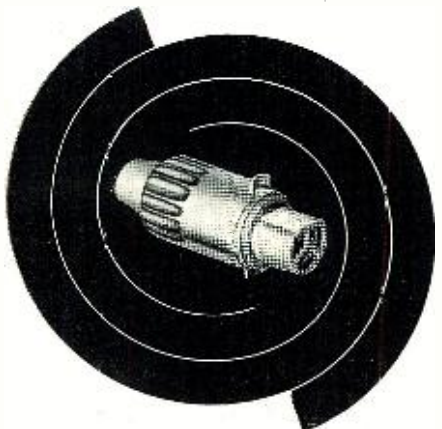

TYPE "U" . . . UP TO 12 CONTACTS

Receptacles Hermetically-sealed

Round steel shells. Pin receptacles have fused vitreous insulators to give true hermetic seal. Adaptable to box- or panel-mounting. Pin or socket plugs have resilient moisture-sealing insulators, gold-plated contacts. Bayonet latch. Cord connectors have resilient sleeves. Contacts 5-amp. Flashover 1700v dc.

Write for Cannon Sub-Miniature Bulletins . . . TODAY! Refer to Dept. 145

CANNON ELECTRIC COMPANY, 3209 Humboldt St., Los Angeles 31, Calif. Representatives and Cannon distributors in all principal cities.



Since 1915

CANNON ELECTRIC

The Curve That Conforms

(Continued from page 49)

of equalization is the occasional recording in which the manufacturer cannot adhere to the standard curve. Why? Simply because the acoustics of certain concert halls and the use of certain repertoire *does not sound good* with the standard curve. This is one of the major reasons why a flexible preamp is still a necessity.

It would be nice if all the LP records now in existence could be recut with the new curve. Given this and a pre-equalized ceramic cartridge of high enough quality, you could dispense with preamps altogether and have "super" systems with undreamed of signal-to-noise ratios. Perhaps this great day will come sooner than we think. In the meantime, it appears that despite RIAA standardization, we will have problems of equalization. You may have caught the term "recut with the new curve" a few sentences ago. As you probably know, the life of a master-mother-stamper is most uncertain. Accidents happen and plates are ruined. Stampers wear out after so many pressings. The procedure when this happens is to get out the tape of the original and cut another master.

The question has probably occurred to you by now (especially in regard to older recordings made prior to the RIAA curve) "Is the new curve used in recutting and how do I identify it?" The answer to this is still further reason for holding on to that preamp of yours. In other words, you will have no way of knowing whether an old recording has been recut with the new RIAA curve, or is still the original curve. There is no escaping the fact that we still must have provision for equalizing the older discs in our libraries as well as sufficient flexibility to equalize those new discs which do not seem to conform to the RIAA standard. Naturally, everyone should be glad that this new RIAA curve seems certain of universal adoption. There is no question that it will make life easier for the harrassed audiophile. It is not, however, the panacea for all of the problems involved in reproducing recordings correctly. You would be ill advised to think otherwise.

Another important question. What should you do if you are planning to build or buy a new preamp? The answer depends on whether or not you have a collection of records or are starting from scratch to build a record library. If you are buying a preamp it will make no difference. Manufacturers will continue to put out preamps incorporating all of the equalization curves. There are too many old records in circulation to warrant changing over to the new curve exclusively.

If you are building your own preamp and have no records on hand, by all means concentrate on the RIAA curve. Your editors will continue to publish, at least for some time, pre-

amplifiers incorporating all of the old curves. In those cases where the RIAA curve is the only one desired, automatically eliminate circuitry for the other curves. This should simplify the over-all preamp construction.

Now, let's hear from the industry about the new curve:

Albert Pulley (Chief Engineer, RCA Victor)—"Of course the new curve is identical with our 'Orthophonic' which we have been using for some time now." (Incidentally, Mr. Pulley pointed out that Victor records marked "New Orthophonic" on their jackets are not merely cut with the new curve, but are so designated because of all the other factors such as microphoning, etc., which is part of the "New Orthophonic" process). All other new Victor records are cut with the new RIAA curve whether or not they state "Orthophonic" on the jackets. Mr. Pulley also asserted that all replacements and even the "Treasury" series would be cut with the RIAA curve whenever possible.

William Bachman (Chief Recording Engineer, Columbia)—"We are using the new RIAA curve in all new Columbia recordings. All replacements will be cut with the RIAA curve whenever possible."

C. Robert Fine (Chief Engineer, Mercury Records)—Mr. Fine indicated that Mercury would go along with the industry in using the RIAA curve in all new releases.

Remy van Wyck Farkas (Director of Artists and Repertoire, London)—"We have been using the RIAA curve for some months now. Our entire catalogue will be recut with the RIAA curve as soon as stocks of the records with the older curve become depleted."

Capitol has been using the RIAA curve for some time now. Decca and MGM will use the new curve in future releases. All of the smaller companies whose output is pressed by Columbia and Victor will use the new curve. Notable exception to the almost solid swing to the RIAA curve is Westminster. Dr. Kurt List stated that for the time being Westminster would use the old NAB curve. Dr. List did not elaborate as to why this should be, but you can be sure Westminster has a valid reason, and we predict that they will hop on the RIAA bandwagon before too long.

Well, that's it! With the adoption of this new curve, the record industry has taken a significant step forward in the direction of standardization. It is to be hoped that this is but the forerunner of more such action in the future.

-30-

INTERNATIONAL CONTACTS

FCC has again reminded amateurs that "radio communications between amateurs of different countries shall be forbidden if the Administration of one of the countries concerned has notified that it objects to such radio-communications."

Cambodia, Indonesia, Iran, Korea, Laos, Thailand, and Vietnam are the countries involved in the ban.

-30-

RADIO & TELEVISION NEWS

Compare! Save!.. on RAD-TEL TUBES and PARTS!

SAME DAY SERVICE . . . OVER 300 TYPES IN STOCK AT ALL TIMES!

70% to 90% OFF on TUBES INDIVIDUALLY FULL YEAR GUARANTEE!

No. 6—70° YOKE

Manufactured by Todd.



Siekie and other leading mfrs. Very good value. makes conversion profitable and simple. Get 'em while they're still around! List price \$7.50.

1.95 Lots of 5
1.80 ea.

No. 7-55° YOKE
99¢ Lots of 3
89c ea.

Granco "Star" UHF CONVERTER

Brand new! Latest model! Unit is highly engineered, receives all UHF channels. Coaxial tuned cavity elements complete with 6AF4 oscillator, 6CB6 I-F and crystal mixer. Shipped ready to install and operate. List Price \$29.95.



22.45
De luxe model Five Star UHF Converter. Pre-selector 1N82-6BQ7 cascade and 6AF4 oscillator. List price \$39.95. 29.97

Philco TV BOOSTER



Completely self-contained, including 2 6J6 tubes . . . 1 for high channels and 1 for low channels and selenium rectifier. Plastic cabinet, in factory-sealed cartons, complete with instructions. No. 125

10.95 In lots of 3
9.95 ea.

STANDARD BOOSTER, COMPLETE, \$5.95

VARIABLE CONDENSERS

Manufactured by Philco, Radio Condenser, etc.

No. 9
Contains 2 separate sections for AM and 2 for FM with pulley condensers. With attached slug tuned high frequency coil whose plunger is geared to condenser shaft. Pulley type drive wheel.

No. 11
Complete with padders and drum pulley drive.

No. 12
Complete with padders and pulley type drive wheel.

Each

Lots of 3

89¢ 79c

89c 79c

79c 69c

89c 79c

No. 96—Famous Standard Coil

Cascade Tuner



Famous standard tuner T front end. Doubles the gain with a great reduction in noise. A MUST for fringe area replacement. Includes tubes 6BK7 or 6BQ7 and 6J6.

List price \$34.50
14.95

ANODE CAPS, 19c ea. Lots of 10
18c ea.

No. 132—Cathode Ray Tube Rejuvenator



Fits all makes of picture tubes. Completely automatic. Easy to install, no tools needed. For A.C. parallel circuits. Your Old Picture Tubes Are Still Useful. List price—\$5.95.

Lots of 10

1.09 each
1.39 each

All New Parts At Old Fashioned SAVINGS!

No. 82—Hi-Watt

RESISTOR KIT



Consisting of 5, 10, 15 and 20 Watt vitreous type resistors by Ward, I.R.C., etc. A top-flight buy!

Assorted Kit of 20

1.95

Lots of 3 kits
\$1.85 ea.

WEN SOLDERING GUN



3 seconds on 120 Volt AC readies it for any soldering requirement. 250 Watt size. Also cuts plastic tile (with special tip). Multi-useful! UL Approved. Built in spot light. 9.71 Each

List price—\$12.95

Lots of 3, 8.64 Each

TIPS

Fenway Long Life . . . 35c ea.

Standard Tip . . . 11c ea.

WEN POLISHER 10.46 ea. Lots of 3
9.30 ea.

No. 47—CERAMICON KIT



1 kit of 50 assorted ceramic discs, biplates, tubular condensers. All condensers popular sizes, used in T.V. and F.M. sets. A MUST kit. List price—\$10.00

Lots of 5

1.89 ea.

No. 75—Army-Navy

HEADSETS



Individually boxed. Very sensitive. Meets both Army and Navy specifications. List price—\$16.00.

2.95 each

per set
Lots of 3 **2.83 ea.**

No. 46—HI-VOLTAGE

R.F. COIL



4500 Volts RF Transformer. Ideal for TV and Oscilloscope power supplies, using 5" to 7" tubes. This buy is too BIG to be beaten! List price—\$7.50.

Lots of 3

79¢ 69c ea.

No. 44—10-INCH

SPEAKER



2.15 oz.

Lots of 5
3.95 3.60 ea.

No. 107

DOUBLE FLYBACK



TTR-172

Up to 13.5KV output. RCA Type Horizontal deflection transformer, with two filament windings for voltage doubler operation. First time at this low price.

Each

Lots of 3

1.89 each
1.79 each

Type	Price	Type	Price	Type	Price	Type	Price
OA2	.74	6AU6	.46	7A5	.59	12X4	.38
OA4	.68	6AV5CT	.83	7A6	.69	14A4	.69
OB2	.81	6AV6	.40	7A7	.69	14A5	.59
OC3	.72	6AX4GT	.65	7A8	.68	14A7	.63
OD3	.70	6B4	.54	7AD7	.79	14AF7	.59
OZ4M	.55	6BA6	.49	7AF7	.53	14B6	.63
1A5	.49	6BA7	.57	7B4	.44	14B8	.63
1A7GT	.47	6BC5	.54	7B5	.45	14C7	.79
1AX2	.62	6BD5	.59	7B6	.69	14E6	.75
1B3GT	.73	6BD6	.45	7B7	.49	14E7	.88
1C5	.43	6BE6	.51	7C4	.59	14F7	.65
1E7	.29	6BF5	.41	7C5	.69	14H7	.59
1G6	.24	6BF6	.37	7C6	.59	14I7	.30
1H4	.30	6BG6G	1.25	7E5	.59	14N7	.84
1H5GT	.49	6BH6	.53	7E6	.30	14R7	.79
1L4	.46	6BJ6	.49	7E7	.59	14S7	.89
1LA4	.59	6BK5	.80	7F7	.79	14W7	.30
1LA6	.69	6BK7	.80	7C7	.89	14X7	.69
1LC5	.59	6BL7GT	.83	7H7	.59	14Y7	.62
1LC6	.79	6BN6	.59	7I7	.79	19BC6	1.39
1LD5	.59	6BQ6GT	.98	7K7	.69	19T8	.69
1LE3	.59	6BQ7	.90	7L7	.59	19V8	.79
1LG5	.69	6BZ7	.90	7N7	.69	24A	.39
1LH4	.69	6C4	.40	7Q7	.66	25AV5GT	.83
1LN5	.59	6C5	.39	7R7	.89	25BQ6GT	.98
1N5GT	.67	6C6	.58	7S7	.79	25L6GT	.51
1P5GT	.57	6CB6	.54	7V7	.89	25W4GT	.59
1Q5GT	.58	6CD6	1.11	7X6	.54	25Z5	.66
1R5	.62	6D6	.59	7X7	.70	25Z6	.49
1S4	.59	6E5	.48	7Y4	.69	26	.45
1S5	.51	6F5CT	.39	7Z4	.59	27	.39
1T4	.58	6F6	.59	12A4	.60	32L7	.89
1U4	.57	6G6	.42	12A6	.54	35	.58
1U5	.50	6H6GT	.41	12A8GT	.61	35B5	.52
1V	.43	6J5GT	.43	12AL5	.37	35C5	.51
1X2A	.63	6J6	.52	12AQ5	.52	35L6GT	.51
2A3	.30	6J7	.43	12AT6	.41	35W4	.47
2W3	.38	6K5	.47	12AT7	.72	35Y4	.54
2X2	.49	6K6GT	.45	12AU6	.46	35Z3	.59
3A4	.45	6K7	.44	12AU7	.60	35Z4	.47
3E5	.46	6L6	.64	12AV6	.39	35Z5GT	.47
3LF4	.69	6L7M	.68	12AV7	.73	36	.39
3Q4	.48	6N7M	.63	12AX4	.67	42	.42
3Q5GT	.49	6Q7	.45	12AX7	.63	45	.55
3S4	.58	6R7	.69	12AY7	.99	45Z3	.44
3V4	.58	6S4	.48	12AZ7	.59	45Z5	.49
5U4G	.55	6S7M	.79	12B4	.60	50A5	.55
5W4GT	.50	6S8CT	.53	12BA6	.49	50B5	.52
5Y3GT	.37	6SA7GT	.55	12BA7	.60	50C5	.51
5Z3	.45	6SD7GT	.41	12BD6	.45	50L6GT	.61
6A6	.51	6SF5GT	.46	12BE6	.51	50Y6	.49
6A7	.69	6SG7CT	.41	12BF6	.39	50Y7	.50
6AB4	.44	6SH7CT	.49	12BH7	.63	55	.49
6AC5	.69	6SJ7GT	.41	12BY7	.65	56	.49
6AC7M	.86	6SK7GT	.53	12BZ7	.65	57	.58
6AF4	.90	6SL7GT	.48	12C8M	.34	58	.60
6AG5	.56	6SN7GT	.59	12H6	.56	70L7	.97
6AG7M	.99	6SQ7CT	.46	12SC7M	.63	75	.49
6AH4	.57	6SR7CT	.45	12J5	.42	76	.44
6AH6	.73	6SS7CT	.42	12J7	.49	77	.57
6AJ5	.65	6T4	.99	12K8	.59	78	.47
6AK5	.55	6T8	.80	12Q7	.59	80	.43
6AK6	.59	6U5	.57	12S8GT	.62	83V	.68
6AL5	.42	6U6	.59	12SA7GT	.65	84/6Z4	.46
6AQ5	.50	6U8	.78	12SF5	.50	85	.59
6AQ6	.37	6V6GT	.50	12SG7	.51	117L7	.99
6AQ7	.70	6W4CT	.47	12SJ7M	.67	117P7	.99
6AR5	.45	6W6GT	.57	12SK7GT	.63	117Z3	.37
6AS5	.50	6X4	.37	12SL7GT	.57	117Z6	.69
6AS6	.69	6X5GT	.37	12SN7GT	.52	807	.99
6AT6	.41	6X8	.75	12SQ7GT	.56	866A	1.39
6AU4GT	.68	6Y6G	.48	12SR7M	.49	Hi-Po	
6AU5GT	.82	7A4	.47	12V6GT	.46	#567	1.39

RAD-TEL TUBE CO.

Dept. RN7

115 Coit St., Irvington 11, N. J. "Integrity Is Our Chief Asset"

TERMS: A 25% deposit must accompany all orders—Balance C.O.D. All shipments F.O.B. Irvington warehouse. ORDERS UNDER \$10—\$1.00 HANDLING CHARGE. Subject to prior sale.

PLEASE: Send full remittance . . . allow for postage and save C.O.D. charges! We refund all unused money!

Send For FREE Illustrated PARTS CATALOGUE

Phone: Essex 5-2947

Tubes in Bold Type Cover 90% of Demand

**NO
INTEREST!!**

Buy on our radically new
Time Payment Plan

**NO CARRYING
CHARGES!!**



Measures 6 1/4" x 9 1/2" x 4 1/2"

Superior's new
Model 670-A

SUPER METER

A COMBINATION VOLT-OHM MILLIAMMETER PLUS
CAPACITY REACTANCE INDUCTANCE AND DECIBEL MEASUREMENTS

SPECIFICATIONS:

D.C. VOLTS: 0 to 7.5/15/75/150/750/1,500/7,500 Volts
A.C. VOLTS: 0 to 15/30/150/300/1,500/3,000 Volts
OUTPUT VOLTS: 0 to 15/30/150/300/1,500/3,000 Volts
D.C. CURRENT: 0 to 1.5/15/150 Ma. 0 to 1.5/15 Amperes
RESISTANCE: 0 to 1,000/100,000 Ohms 0 to 10 Megohms
CAPACITY: .001 to 1 Mfd. 1 to 50 Mfd. (Quality test for electrolytics)
REACTANCE: 50 to 2,500 Ohms, 2,500 Ohms to 2.5 Megohms
INDUCTANCE: .15 to 7 Henrys 7 to 7,000 Henrys
DECIBELS: -6 to +18 +14 to +38 +34 to +58

ADDED FEATURE:

The Model 670-A includes a special **GOOD-BAD** scale for checking the quality of electrolytic condensers at a test potential of 150 Volts.

The Model 670-A comes housed in a rugged, crackle-finished steel cabinet complete with test leads and operating instructions.

\$28⁴⁰
NET



Superior's new
Model TV-11

TUBE TESTER

SPECIFICATIONS:

- ★ Tests all tubes including 4, 5, 6, 7, Octal, Lock-in, Peanut, Bantam, Hearing Aid, Thyatron, Miniatures, Sub-Miniatures, Novals, Sub-minars, Proximity fuse types, etc.
- ★ Uses the new self-cleaning Lever Action Switches for individual element testing. Because all elements are numbered according to pin-number in the RMA base numbering system, the user can instantly identify which element is under test. Tubes having tapped filaments and tubes with filaments terminating in more than one pin are truly tested with the Model TV-11 as any of the pins may be placed in the neutral position when necessary.
- ★ The Model TV-11 does not use any combination type sockets. Instead individual sockets are used for each type of tube. Thus it is impossible

- to damage a tube by inserting it in the wrong socket.
- ★ Free-moving built-in roll chart provides complete data for all tubes.
- ★ Newly designed Line Voltage Control compensates for variation of any Line Voltage between 105 Volts and 130 Volts.
- ★ **NOISE TEST:** Phono-jack on front panel for plugging in either phones or external amplifier will detect microphonic tubes or noise due to faulty elements and loose internal connections.

The model TV-11 operates on 105-130 Volt 60 Cycles A.C. Comes housed in a beautiful hand-rubbed oak cabinet complete with portable cover.

EXTRA SERVICE—The Model TV-11 may be used as an extremely sensitive Condenser Leakage Checker. A relaxation type oscil-

lator incorporated in this model will detect leakages even when the frequency is one per minute.

\$47⁵⁰
NET

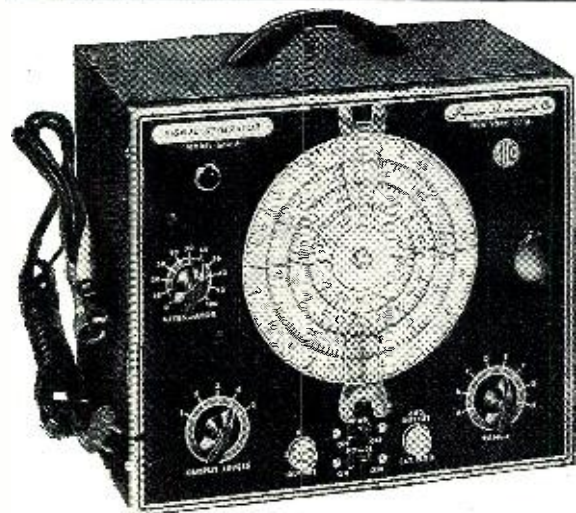

Superior's New Model 660-A AN AC OPERATED
SIGNAL GENERATOR

PROVIDES COMPLETE COVERAGE for AM-FM & TV Alignment

SPECIFICATIONS:

• Generates Radio Frequencies from 100 Kilocycles to 60 Megacycles on fundamentals and from 60 Megacycles to 220 Megacycles on powerful harmonics. • Accuracy and Stability are assured by the use of permeability trimmed Hi-Q coils. • R.F. available separately or modulated by the internal audio oscillator. — Built in 400 cycle sine wave audio oscillator used to modulate the R.F. signal also available separately for audio testing of receivers, amplifiers, hard of hearing aids, etc. • R.F. Oscillator Circuit: A

high transconductance heptode is used as an R.F. oscillator, mixer and amplifier. Modulation is effected by electron coupling in the mixer section thus isolating the oscillator from load changes and affording high stability. • A.F. Oscillator Circuit: A high transconductance heptode connected as a high- μ triode is used as an audio oscillator in a High-C Colpitts Circuit. The output (over 1 Volt) is nearly pure sine wave. • Attenuator: A 5 step ladder type of attenuator is used.

TUBES USED:

- 1—6BE6 as R.F. Oscillator, mixer and amplifier
- 1—6BE6 as Audio Oscillator
- 1—6H6 as Power Rectifier

THE MODEL 660-A COMES COMPLETE WITH COAXIAL CABLE, TEST LEAD AND INSTRUCTIONS.

\$42⁹⁵
NET

MOSS ELECTRONIC DISTRIBUTING CO., INC.
Dept. B-104, 3849 Tenth Ave., New York 34, N.Y.

Please send me the units checked. I am enclosing the down payment with order and agree to pay the monthly balance as shown. It is understood there will be no carrying interest or any other charges provided I send my monthly payments when due. It is further understood that should I fail to make payment when due, the full unpaid balance shall become immediately due and payable.

Name.....
Address.....
City.....Zone.....State.....

- MODEL 670-A..... Total Price \$28.40 \$7.40 down payment. Balance \$3.50 monthly for 6 months.
- MODEL TV-11..... Total Price \$47.50 \$11.50 down payment. Balance \$6.00 monthly for 6 months
- MODEL 660-A..... Total Price \$42.95 \$12.95 down payment. Balance \$5.00 monthly for 6 months.
- I enclose \$..... as down payment.
- Ship C.O.D. for the down payment.

NO INTEREST!!

Buy on our radically new
Time Payment Plan

NO CARRYING CHARGES!!



Superior's New Model 770-A

The FIRST Pocket-Sized

VOLT-OHM MILLIAMMETER
USING THE NEW "FULL VIEW" METER

71% MORE SCALE AREA!!

Yes, although our new FULL-VIEW D'Arsonval type meter occupies exactly the same space used by the older standard 2 1/2" Meters, it provides 71% more scale area. As a result, all calibrations are printed in large easy-to-read type and for the first time it is now possible to obtain measurements instead of approximations on a popular priced pocket-sized V.O.M.

Features

- ★ Compact—measures 3 1/8" x 5 7/8" x 2 1/4"
- ★ Uses "Full View" 2% accurate, 850 Microampere D'Arsonval type meter
- ★ Housed in round-cornered, molded case
- ★ Beautiful black etched panel. Depressed letters filled with permanent white, insures long-life even with constant use.

Specifications

6 A.C. VOLTAGE RANGES: 0-15/30/-150/300/1500/3000 Volts. 6 D.C. VOLTAGE RANGES: 0-7.5/15/75/150/-750/1500 Volts. 2 RESISTANCE RANGES: 0-10,000 Ohms, 0-1 Megohm. 3 D.C. CURRENT RANGES: 0-15/150 Ma., 0-1.5 Amps. 3 DECIBEL RANGES: -6 db to +18 db, +14 db to +38 db, +34 db to +58 db.

\$15⁸⁵
NET

THE MODEL 770-A COMES COMPLETE WITH SELF-CONTAINED BATTERIES, TEST LEADS AND ALL OPERATING INSTRUCTIONS. ONLY



Superior's New Model 70 UTILITY TESTER

FOR REPAIRING ALL ELECTRICAL APPLIANCES • MOTORS • AUTOS

As an electrical trouble shooter the Model 70:

- Measures A.C. and D.C. Voltages, A.C. and D.C. Current, Resistances, Leakages, etc.
- Will measure current consumption while the appliance under test is in operation.
- Incorporates a sensitive direct-reading resistance range which will measure all resistances commonly used in electrical appliances, motors, etc.
- Leakage detecting circuit will indicate continuity from zero ohms to 5 megohms (5,000,000 ohms).
- Will test Toasters, Irons, Broilers, Heating Pads, Clocks, Fans, Vacuum Cleaners, Refrigerators, Lamps, Fluorescents, Switches, Thermostats, etc.

As an Automotive Tester the Model 70 will test:

- Both 6 Volt and 12 Volt Storage Batteries • Generators • Starters • Distributors • Ignition Coils • Regulators • Relays • Circuit Breakers • Cigarette Lighters • Stop Lights • Condensers • Directional Signal Systems • All Lamps and Bulbs • Fuses • Heating Systems • Horns • Also will locate poor grounds, breaks in wiring, poor connections, etc.

Handsome round-cornered molded bakelite case, 3 1/8" x 5 7/8" x 2 1/4". Complete with all test leads. Also included is a 64 page book giving detailed instructions for testing all electrical appliances, automotive equipment, etc.

\$15⁸⁵
NET

SUPERIOR'S NEW MODEL TV-40

C.R.T. TUBE TESTER



★ A complete picture tube tester for little more than the price of a "make-shift" adapter!!

The Model TV-40 is absolutely complete! Self-contained, including built-in power supply, it tests picture tubes in the only practical way to efficiently test such tubes: that is by the use of a separate instrument which is designed exclusively to test the ever increasing number of picture tubes!

EASY TO USE:

Simply insert line cord into any 110 volt A.C. outlet, then attach tester socket to tube base (ion trap need not be on tube). Throw switch up for quality test . . . read direct on Good-Bad scale. Throw switch down for all leakage tests.

★ Tests all magnetically deflected tubes . . . in the set . . . out of the set . . . in the carton!!

SPECIFICATIONS:

- Tests all magnetically deflected picture tubes from 7 inch to 30 inch types.
- Tests for quality by the well established emission method. All readings on "Good-Bad" scale.
- Tests for inter-element shorts and leakages up to 5 megohms.
- Tests for open elements.

Model TV-40 C.R.T. Tube Tester comes absolutely complete—nothing else to buy. Housed in round cornered, molded bakelite case. Only

\$15⁸⁵
NET

MOSS ELECTRONIC DISTRIBUTING CO., INC.
Dept. B-104, 3849 Tenth Ave., New York 34, N. Y.

Please send me the units checked. I am enclosing the down payment with order and agree to pay the monthly balance as shown. It is understood there will be no carrying, interest or any other charges, provided I send my monthly payments when due. It is further understood that should I fail to make payment when due, the full unpaid balance shall become immediately due and payable.

Name.....
Address.....
City.....Zone.....State.....

- Model 770-A Total Price \$15.85 \$3.85 down payment. Balance \$4.00 monthly for 3 months.
- Model 70 Total Price \$15.85 \$3.85 down payment. Balance \$4.00 monthly for 3 months.
- Model TV-40 Total Price \$15.85 \$3.85 down payment. Balance \$4.00 monthly for 3 months.
- I enclose \$..... as down payment.
- Ship C.O.D. for the down payment.

UHF TRANSMITTER-RECEIVER

APS-13

\$4.95

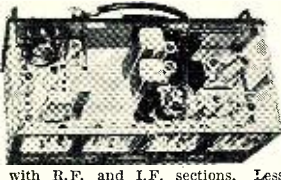

Freq. range 415-420 MC. 5 stages of 30 MC. I.F. amplifier. Complete with R.F. and I.F. sections. Less dynamotor and tubes. With schematic. Excel. cond.

ARC-5/R-28 2-METER RECEIVER

Here is the 2-meter superhet you have been looking for! Absolutely one of the BEST available today! Tunes from 100 to 156 Mcs. in four crystal channels. (Easily converted to continuous tuning.) Tube lineup is as follows: 717A—R.F., 717A—Mixer, 2—12SH7—1st and 2nd I.F. 16.9 Mc.

EXCEL. COND. \$19.95

AN-75 PORTABLE ANTENNA—With Base

For portable or vehicular operation. Used as a portable, antenna is clamped to radio housing. On vehicles, it is clamped under hood or to other support. Collapsed length is 12 inches. Extends to 84 inches. Flexible. New.....

\$1.95

SCR-183 TRANSMITTER RECEIVER. Complete with 12 V. dynamotor and tubes. 40, 80 meter. F.B. for mobile. New with service manual. \$24.50

TG-10 CODE KEYS

Self-Contained Automatic unit for code practice signals from an inked type recording. Complete with 7 tubes and electric eye; Audio freq. output of 800 CPS. Size: 11 x 24 x 18 1/2"—110-220 VAC 60 cy.—78 RPM motor can be used for a turntable—Power unit can be used for a P.A. system—wt. 65 lbs. Brand New.....

\$22.50



C.A.P. SPECIAL BC-625 VHF TRANSMITTER

Freq. range 100-156 MC. With modulation section and speech amplifier. Less tubes & crystals, with conversion dope. Used, good condition. (See Nov/53 CQ.)

\$9.95

ARB NAVY RECEIVER

105 to 9050 KC. Four Bands. Calibrated Dial, LF-Ship-BC-80 & 40 Meter—Complete with Tubes and Dynamotor. For 24 Volt operation; easily converted to 110 V.—12 or 6 Volt. Size: 8 1/4" x 7 1/4" x 15 1/4". Excellent cond.

\$29.50

With schematic. DU-I. DIRECTION FINDER LOOP AMPLIFIER for ARB receiver. With tubes and loop. Excellent condition. With schematic.... \$19.95



ID6/APN4

Made to operate in conjunction with Radio Receiver R9/APN-4. Unit uses 19 tubes, one 5" scope tube, crystal controlled standard oscillator, sweep circuits, marker pulses. Excellent cond. Less tubes.....

\$24.50

WITH TUBES & CRYSTAL..... \$39.50
DYNAMOTOR SPECIAL: 0 V. input. Output 450 V. 75 mls. With extended shaft and drive gear on one end. New..... \$7.95

BEST HEADSET & MIKE BUYS

H-160 HEADSET. 8,000 ohms..... \$3.95
HS-18 HEADSET. New..... 2.45
HS-23 HEADSET. High imp. New..... 4.95
HS-30 HEADSET. Featherweight type. Low imp. NEW \$2.49 USED..... 1.49
HS-33 HEADSET. Low imp. New..... 5.50
HS-38 HEADSET. USED, excel. cond..... 1.49
NEW..... 3.50
RS-38 MIKE. NEW \$4.95 Excel..... 2.75

PE-125 POWER SUPPLY: Operates on 12 \$17.95 or 24 V. battery. NEW.....

T9—MODULATION TRANSFORMER. For BC-610 Transmitter. Pri. 16,000 ohms CT; sec. 8,330 ohms @ 250 ma. Fully shielded steel case. New. \$34.50



Sound Powered Handset TS-10

Uses no batteries or external power source. Ideal for TV installation work, farms, construction projects, connecting outbuildings, extensions, etc., includes 5 ft. cord.

NEW. Each..... \$ 9.95
NEW. Per Pr. 18.50

FREE HAM FLYER!

Featuring Loads of Special Values
SEND FOR YOUR COPY TODAY!

All shpts. F.O.B. whse. Calif. residents add sales tax, 25% deposit required. Specify shipping instructions and ADD SHIPPING COSTS TO EACH ORDER. All items subject to prior sale and change of price without notice.

ARROW SALES INC.

Mailing Address: Box 3878-R, North Hollywood, Cal.
Office-Warehouse: 7460 Varna Ave., N. Hollywood, Cal.

WHAT'S

New in Radio

The products described in this column are for your convenience in keeping up-to-date on the new equipment being offered by manufacturers. For more complete information on any of these products, write direct to the company involved.

SERVICE INSTRUMENT

The Hickok Electrical Instrument Company, 10524 Dupont Avenue, Cleveland 8, Ohio, is now offering a new multi-range electronic volt-ohm-

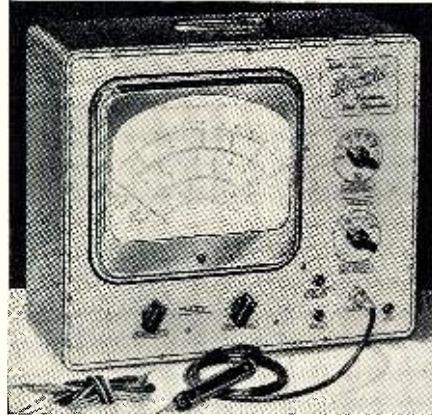

meter which is designed to speed radio and TV servicing.

The Model 225 is designed around a 9" internal pivot meter and features extra long scales to minimize reading errors and permit the unit to be used at practical working distances.

The new unit matches other instruments in the company's line and is housed in a blue hammertex steel case 16" wide, 13" high, and 7" deep. Complete specifications are available from the company on request.

EQUIPMENT ENCLOSURES

Elgin Metalformers Corporation, 906 N. Liberty St., Elgin, Illinois is now offering a new instrument cabinet which comes in a baked-on, two-tone, smooth enamel finish.

The top, bottom, back, and both end panels are quickly removable with a screwdriver, allowing complete access to the interior. The new "Emcor" cabinets can be stacked vertically or horizontally and locked together with "Speed Nuts" and a screwdriver. The unit accommodates chassis with a 8 3/4" x 19" front panel and a depth of 15". Chassis guide supports are adjustable to chassis of any width up to 17".

BASIC PRINTED CIRCUITS

Tri-Dex Company, P. O. Box 1207, Lindsay, California is now offering a line of standard printed circuit boards for experimental and laboratory development applications.

Six compact standard "Tri-Dexes" provide for most tube and basic circuits. A seventh unit is universal for filtered power supplies. Each unit is mounted directly on a tube socket and provides clearly marked, preconnected eyelets for all resistors and condensers

for each basic circuit. Any suitable resistors and condensers may be used. Each stage may be quickly assembled as a compact unit and shielded with the aluminum plate provided.

Each "Tri-Dex" is supplied complete with instructions, shield, and mounting hardware.

"DUOVOLT" GENEMOTOR

Carter Motor Co., 2641 N. Maplewood Avenue, Chicago 47, Illinois has announced the availability of a dual-voltage genemotor that will operate on either 6 or 12 volts.

"Duovolt" powered mobile radio equipment may be transferred from one car to another, irrespective of battery voltage, without impairment of transmitting and receiving quality, without replacement of the genemotor, and without modification of the wiring hookup.

The new unit incorporates two separate 6-volt input windings, each having its own field. Six or 12-volt operation is obtained simply by connecting the four input leads in parallel or in series.

For complete information, mechanical and electrical specifications, write Dept. 7 of the company.

I.F. TRANSFORMER

Aladdin Radio Industries, Inc., Nashville, Tenn. is in production on a unique 43 mc. i.f. transformer with a tuning range of 25 to 90 mc.

Tradenamed the "Ulti-Mite," the new transformer features a new tuning principle that eliminates the conventional powdered iron core. Molded nylon studs provide smooth tuning that is not affected by vibration.

All adjustments are made from the

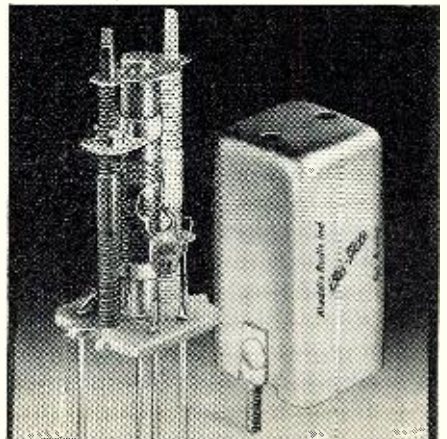

top, only the terminals are exposed through the special molded base. The base is a heat-resistant polyester resin which is stable and not affected by

heat. The "Ulti-Mite" can be dip-soldered with printed circuits as well as adapted to conventional strips. All units, interstage or diode, are housed in 7/8" square aluminum cans with either spade bolt or solder lug mountings.

COMPONENT BRIDGE

Cornell-Dubilier Electric Corp., South Plainfield, N. J. has introduced a condenser-resistor bridge, the BF-60, which measures the important charac-

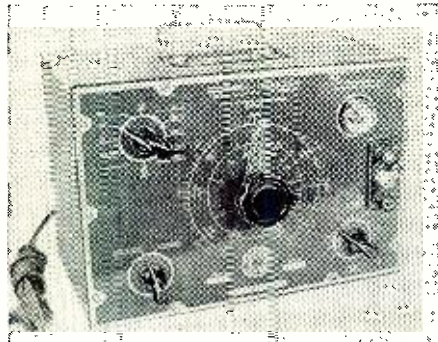

teristics of virtually all types of condensers and resistors and determines their quality.

The new instrument detects opens, shorts, and intermittents; the capacity between wires and shieldings; transformer windings; wires in cables and makes possible the measurements of insulation resistance of paper, mica, and ceramic dielectric condensers.

For full details on this new portable bridge, write E. J. Maginot, sales promotion manager of the company.

FOUNDATION CHASSIS

A series of five new foundation chassis, suitable for amplifiers, transmitters, power supplies, and other electronic applications has been introduced by Insuline Corporation of America, Manchester, N. H.

The units feature perforated covers that provide both ventilation and protection for parts mounted inside. Made of heavy steel, the chassis and covers are finished in marine gray ripple enamel. Detachable side handles are included.

The chassis depth is three inches. Over-all dimensions of the five models are: No. 3965—5 1/2" x 10" x 9"; No. 3966—8" x 12" x 9"; No. 3967—7" x 17" x 9"; No. 3968—10" x 14" x 9"; and No. 3969—10" x 17" x 9". Special sizes are available on a custom basis.

HIGH-VOLTAGE CONDENSERS

Centralab, 900 E. Keefe Ave., Milwaukee 1, Wisconsin is now offering a new line of precision high-voltage condensers which have been designed to eliminate the twisting off or breakage of terminals.

The condensers are available in 500 µfd., 20,000 volt sizes. Heavy 8-32 threads on both the terminal and condenser lock the terminal tightly and precisely into the "Hi-Vo-Kap." Internal corona is prevented by seating the

terminal at the bottom of the condenser tap, thus avoiding any air gap.

The new attachable terminal condensers are available singly or in packs of five. Write Department E10 for copies of bulletins 28-2 and 42-201 covering these units.

TRANSISTOR KIT

Precise Development Corp., Ocean-side, Long Island, N. Y. is marketing a transistor kit, the Model T1.

The new kit includes all equipment, transistors, transformers, coils, etc., necessary to permit the purchaser to acquire basic transistor knowledge through actual experimental and practical use of audio one-stage amplifiers through transformer-coupled amplifiers and special circuits.

A simple instruction book covers the physics of transistors and shows the applications.

TEST SOCKET ADAPTER

Pomona Electronics Co., 524 W. Fifth Ave., Pomona, California has introduced three new service aids to the electronics field.

The new units consist of 7- and 9-pin miniature test socket adapters and an 8-pin octal test socket adapter. They may be used for making measurements of voltage, resistance, audio, and video from the top of the chassis while the set is in operation.

The adapters are inserted between the tube base and its socket. This completes the circuit and makes all

New TELEVISION COURSE
Amazing Bargain, Complete, Only \$3

NEW PRACTICAL COURSE

Here is your complete training in television servicing. Amazing value at only \$3. complete. These new lessons cover every fact, adjustment and repair of all types and makes of TV receivers. Giant in size, mammoth in scope. Just like other correspondence courses selling for over \$150.00. Our amazing offer permits you to obtain the course complete for only \$3.

COMPLETE TV TRAINING

New, easy-to-follow, well illustrated lessons on circuits, picture faults, adjustments, short cuts, about UHF, alignment, antenna problems, trouble-shooting, service hints, how to use test equipment. Many large practical sections prepared by leading manufacturers. Just published. Send trial coupon today and use the complete Television Servicing Course at our risk.

COVERS EVERYTHING IN TV

Let these course-lessons take you into TV servicing the easy way. The very first lesson of this sensational course tells how to do simple repairs. You can start earning money immediately. Second lesson tells you what is wrong, by just looking at the picture — no instruments used. Lesson 4 has 32 large, 3 1/2 x 11" pages and 28 large illustrations on antenna installations and improvements. Another 12 lessons deal with trouble-shooting, alignment, UHF converters, test equipment, picture analysis, and all types of new circuits.

AMAZING BARGAIN VALUE

With this new course you will find yourself doing TV repairs in minutes — instantly finding faults. Most amazing bargain. Examine this course for 10 days. Look over this material, read a few lessons, apply some of the hints. Then decide to keep the lessons at the bargain cost of \$3 (full price), or return the material.

RADIO and TV Manuals

Your complete source for all needed RADIO and TV diagrams and servicing data. Most amazing values. Still sold at pre-Korean prices. Only \$2 to \$3 per volume. Every Radio manual contains large schematics, all needed alignment facts, parts lists, voltage values, trimmers, dial stringing, and service hints. Each TV volume is a practical treatise on servicing a full year's sets, with giant blueprints, waveforms, hints, alignment and voltage charts, production changes. See coupon at right for a complete list of these low priced Supreme service manuals.

Most Often Needed
1954
Television
Servicing Information

Supreme Publications
Sold by all Leading Parts Jobbers

NO-RISK TRIAL ORDER COUPON

SUPREME PUBLICATIONS, 1760 Balsam Rd., Highland Park, Ill.

<p>Radio Diagram Manuals</p> <ul style="list-style-type: none"> <input type="checkbox"/> 1953 Radio Manual, \$2.50 <input type="checkbox"/> 1952 Radio <input type="checkbox"/> 1951 Diagrams <input type="checkbox"/> 1950 Manual <input type="checkbox"/> 1949 Radio <input type="checkbox"/> 1948 <input type="checkbox"/> 1947 <input type="checkbox"/> 1946 <input type="checkbox"/> 1942 <input type="checkbox"/> 1941 <input type="checkbox"/> 1940 <input type="checkbox"/> 1939 <input type="checkbox"/> 1926-1938 Manual, \$2.50 <input type="checkbox"/> Master INDEX only 25¢ 	<p>Radio Manual, \$2.50</p> <p>EACH</p> <p>\$2</p> <p>EACH</p>	<p>Radio Manual, \$2.50</p> <p>Radio manuals at left. Satisfaction guaranteed.</p> <ul style="list-style-type: none"> <input type="checkbox"/> New Television Servicing Course, complete . . . \$3. <input type="checkbox"/> Latest 1954 Television Servicing Manual, only . . . \$3. <input type="checkbox"/> 1953 TV Manual, \$3. <input type="checkbox"/> 1953 UHF Units, \$1.50 <input type="checkbox"/> 1952 Television Manual, \$3. <input type="checkbox"/> 1951 TV, \$3. <input type="checkbox"/> 1950 Television Manual, \$3. <input type="checkbox"/> 1949 TV, \$3. <input type="checkbox"/> 1948 TV, \$3. <input type="checkbox"/> 1947 TV & FM, only \$2. <p><input type="checkbox"/> I am enclosing \$ Send postpaid.</p> <p><input type="checkbox"/> Send C.O.D. I am enclosing \$ deposit.</p> <p>Name:</p> <p>Address:</p>
--------------------------------------------------------------------------------------------------------------------------------------------------------------------------------------------------------------------------------------------------------------------------------------------------------------------------------------------------------------------------------------------------------------------------------------------------------------------------------------------------------------------------------------------------------------------------------------------------------------------------------------------------------------------------------------------------------------------------------------	--------------------------------------------------------------------------------------------	--------------------------------------------------------------------------------------------------------------------------------------------------------------------------------------------------------------------------------------------------------------------------------------------------------------------------------------------------------------------------------------------------------------------------------------------------------------------------------------------------------------------------------------------------------------------------------------------------------------------------------------------------------------------------------------------------------------------------------------------------------------------------------------------------------------------------------------------------------------------------------------------------------------------------------------------------------------------------------------

TUBES & PARTS

Don't read this ad if you are looking for cheap tubes. But if you want GOOD TUBES at reasonable prices, this is for YOU.

ALL TUBES are guaranteed for one year... individually boxed.

Very BEST BRANDS available for immediate delivery.

0A4G	1.19	2A6	89c	6AH6	1.89	6BH6	69c	6K5GT	.69	6S07	.76	12AU6	.77	12SN7GT	.95	26	57	79c				
0Z4	59c	2A7	89c	6AJ5	2.95	6BJ6	69c	6K6GT	.69	6S07GT	.59c	12AV6	.59	12T07	.29	27	58	79c				
1A0	79	2B3	.89	6AK5	.89	6BK7	1.19	6K7GT	.69	6SR7GT	.69	12AV7	.89	12S07GT	.69c	35A5	.95	70L7	1.49			
1A7GT	79	2B7	.89	6AK6	1.19	6BL7	.79	6K8GT	1.19	6SS7	.99	12AW6	1.19	12S07GT	.69c	35B5	.95	70L7GT	1.49			
1B3GT	95	2C2	87/79	6AL5	.89	6BN6	1.19	6L5G	.95	6T8	.89	12AX4	.69	12Z3	.95	35C5	.95	71A	79c			
1B5	29c	3L4	1.29	6A05	69c	6BO6	1.19	6L6G	1.39	6U8	1.29	12AX7	.69	14A7	95c	35L6	.69	75	79c			
1H4	59c	30A	1.29	6A07	1.19	6B07	1.29	6L7	1.19	6U8GT	1.19	12BA6	1.19	14A8	89c	35W4	.59	77	79c			
1H5GT	59c	30SGT	.89	6AR5	.79	6B27	1.29	6L8	1.29	6V6GT	.69	12BA7	1.19	14B8	89c	35Z3	.95	78/6D6	.69			
1J6GT	59c	3S4	.69	6AT6	.59	6C4	.59	6N7GT	1.19	6W6	.59	12BE6	.69c	14C5	1.19	35Z4	.69	80	450V	.49		
1L4	1.19	3V4	.35	6AS5	.89	6C5GT	.69	6P9GT	.69	6V6GT	.69	12BH7	.89	14C7	.95	35Z5	.69	81	450V	.49		
1L6	1.29	5T4	1.29	6AU5GT	1.29	6C6	.69c	6Q7GT	.59	6W4GT	.59	12BT6	.89	14F7	95c	35/51	.79	84/6Z4	.69	82	450V	.49
1L8	1.19	5U4G	.69	6A06	.59	6D88	1.19	6R7GT	.69	6W6	.59	12T6	.89	14F8	89c	37	.37	85	85	89	450V	.49
1L9	1.19	5V4G	.59	6AV5GT	.89	6C8	1.29	6S4	.59	6X4	.69	12T6GT	.89	14H7	1.29	38	.38	86	86	89	450V	.49
1L5	1.19	5X4G	.87c	6AV6	.59	6C06	1.89	6S7GT	1.19	6X5GT	59c	12H6	.89	14I7	1.19	39/44	.39	87	87	89	450V	.49
1N5GT	79c	6A7	.89	6AX5	.79	6C6F	1.19	6SA7GT	69c	6X8	1.29	12K7GT	69c	14J7	1.19	41	.41	88	88	89	450V	.49
1P5GT	79c	6A8GT	1.29	6AY5GT	.89	6D6/78	1.19	6SC7	69c	6Y6G	69c	12K8	.89	14K7	1.19	42	.42	89	89	89	450V	.49
1Q5GT	79c	6A9	.89	6B4G	1.29	6E5	.69	6S07GT	69c	6Z4/84	69c	12L8	.89	14L7	1.19	43	.43	90	90	90	450V	.49
1R5	1.19	6A8	.89	6BA6	.59	6F5GT	59c	6S1GT	69c	6S07GT	69c	12M8	.89	14M7	1.19	44	.44	91	91	91	450V	.49
1S4	.95	6A7	.89	6B7	.89	6F7	1.59	6S2GT	69c	6S07GT	69c	12N8	.89	14N7	1.19	45	.45	92	92	92	450V	.49
1S5	.95	6A8	.89	6B8	.89	6F8G	1.59	6S3GT	69c	6S07GT	69c	12P8	.89	14P7	1.19	46	.46	93	93	93	450V	.49
1T4	.69c	6A7	.89	6B9	.89	6G6G	.95	6S4GT	69c	6S07GT	69c	12Q8	.89	14Q7	1.19	47	.47	94	94	94	450V	.49
1U4	.69c	6A8	.89	6B0	.89	6G6G	.95	6S5GT	69c	6S07GT	69c	12R8	.89	14R7	1.19	48	.48	95	95	95	450V	.49
1U5	.59	6A9	.89	6B1	.89	6G6G	.95	6S6GT	69c	6S07GT	69c	12S8	.89	14S7	1.19	49	.49	96	96	96	450V	.49
1V	.89c	6A05	.59	6B2	.89	6G6G	.95	6S7GT	69c	6S07GT	69c	12T8	.89	14T7	1.19	50	.50	97	97	97	450V	.49
1X2A	.89c	6A67	1.49	6B3	.89	6G6G	.95	6S8GT	69c	6S07GT	69c	12U8	.89	14U7	1.19	51	.51	98	98	98	450V	.49

6K5GT	.69	6S07	.76	12AU6	.77	12SN7GT	.95	26	57	79c				
6K6GT	.69	6S07GT	.59c	12AV6	.59	12T07	.29	27	58	79c				
6K7GT	.69	6SR7GT	.69	12AV7	.89	12S07GT	.69c	35A5	.95	70L7	1.49			
6K8GT	1.19	6SS7	.99	12AW6	1.19	12S07GT	.69c	35B5	.95	70L7GT	1.49			
6L5G	.95	6T8	.89	12AX4	.69	12Z3	.95	35C5	.95	71A	79c			
6L6G	1.39	6U8	1.29	12AX7	.69	14A7	95c	35L6	.69	75	79c			
6L7	1.19	6U8GT	1.19	12BA6	1.19	14A8	89c	35W4	.59	77	79c			
6L8	1.29	6V6GT	.69	12BA7	1.19	14B8	89c	35Z3	.95	78/6D6	.69			
6N7GT	1.19	6W6	.59	12BE6	.69c	14C5	1.19	35Z4	.69	80	450V	.49		
6P9GT	.69	6X4	.69	12BH7	.89	14C7	.95	35Z5	.69	81	450V	.49		
6Q7GT	.59	6X5GT	59c	12BT6	.89	14F7	95c	35/51	.79	84/6Z4	.69			
6R7GT	.69	6X8	1.29	12C7GT	.89	14F8	89c	37	.37	85	85	89	450V	.49
6S4	.59	6Y6G	69c	12C8	.89	14H7	1.29	38	.38	86	86	89	450V	.49
6S7GT	1.19	6Z4/84	69c	12D8	.89	14I7	1.19	39/44	.39	87	87	89	450V	.49
6S8GT	1.19	6S07GT	69c	12E8	.89	14J7	1.19	41	.41	88	88	89	450V	.49
6S9GT	1.19	6S07GT	69c	12F8	.89	14K7	1.19	42	.42	89	89	89	450V	.49
6S07GT	69c	6S07GT	69c	12G8	.89	14L7	1.19	43	.43	90	90	90	450V	.49
6S1GT	69c	6S07GT	69c	12H8	.89	14M7	1.19	44	.44	91	91	91	450V	.49
6S2GT	69c	6S07GT	69c	12I8	.89	14N7	1.19	45	.45	92	92	92	450V	.49
6S3GT	69c	6S07GT	69c	12J8	.89	14P7	1.19	46	.46	93	93	93	450V	.49
6S4GT	69c	6S07GT	69c	12K8	.89	14Q7	1.19	47	.47	94	94	94	450V	.49
6S5GT	69c	6S07GT	69c	12L8	.89	14R7	1.19	48	.48	95	95	95	450V	.49
6S6GT	69c	6S07GT	69c	12M8	.89	14S7	1.19	49	.49	96	96	96	450V	.49
6S7GT	69c	6S07GT	69c	12N8	.89	14T7	1.19	50	.50	97	97	97	450V	.49
6S8GT	69c	6S07GT	69c	12P8	.89	14U7	1.19	51	.51	98	98	98	450V	.49
6S9GT	69c	6S07GT	69c	12Q8	.89	14V7	1.19	52	.52	99	99	99	450V	.49
6S07GT	69c	6S07GT	69c	12R8	.89	14W7	1.19	53	.53	100	100	100	450V	.49
6S1GT	69c	6S07GT	69c	12S8	.89	14X7	1.19	54	.54	101	101	101	450V	.49
6S2GT	69c	6S07GT	69c	12T8	.89	14Y7	1.19	55	.55	102	102	102	450V	.49
6S3GT	69c	6S07GT	69c	12U8	.89	14Z7	1.19	56	.56	103	103	103	450V	.49
6S4GT	69c	6S07GT	69c	12V8	.89	14A7	1.19	57	.57	104	104	104	450V	.49
6S5GT	69c	6S07GT	69c	12W8	.89	14B7	1.19	58	.58	105	105	105	450V	.49
6S6GT	69c	6S07GT	69c	12X8	.89	14C7	1.19	59	.59	106	106	106	450V	.49
6S7GT	69c	6S07GT	69c	12Y8	.89	14D7	1.19	60	.60	107	107	107	450V	.49
6S8GT	69c	6S07GT	69c	12Z8	.89	14E7	1.19	61	.61	108	108	108	450V	.49
6S9GT	69c	6S07GT	69c	12A8	.89	14F7	1.19	62	.62	109	109	109	450V	.49
6S07GT	69c	6S07GT	69c	12B8	.89	14G7	1.19	63	.63	110	110	110	450V	.49
6S1GT	69c	6S07GT	69c	12C8	.89	14H7	1.19	64	.64	111	111	111	450V	.49
6S2GT	69c	6S07GT	69c	12D8	.89	14I7	1.19	65	.65	112	112	112	450V	.49
6S3GT	69c	6S07GT	69c	12E8	.89	14J7	1.19	66	.66	113	113	113	450V	.49
6S4GT	69c	6S07GT	69c	12F8	.89	14K7	1.19	67	.67	114	114	114	450V	.49
6S5GT	69c	6S07GT	69c	12G8	.89	14L7	1.19	68	.68	115	115	115	450V	.49
6S6GT	69c	6S07GT	69c	12H8	.89	14M7	1.19	69	.69	116	116	116	450V	.49
6S7GT	69c	6S07GT	69c	12I8	.89	14N7	1.19	70	.70	117	117	117	450V	.49
6S8GT	69c	6S07GT	69c	12J8	.89	14P7	1.19	71	.71	118	118	118	450V	.49
6S9GT	69c	6S07GT	69c	12K8	.89	14Q7	1.19	72	.72	119	119	119	450V	.49
6S07GT	69c	6S07GT	69c	12L8	.89	14R7	1.19	73	.73	120	120	120	450V	.49
6S1GT	69c	6S07GT	69c	12M8	.89	14S7	1.19	74	.74	121	121	121	450V	.49
6S2GT	69c	6S07GT	69c	12N8	.89	14T7	1.19	75	.75	122	122	122	450V	.49
6S3GT	69c	6S07GT	69c	12P8	.89	14U7	1.19	76	.76	123	123	123	450V	.49
6S4GT	69c	6S07GT	69c	12Q8	.89	14V7	1.19	77	.77	124	124	124	450V	.49
6S5GT	69c	6S07GT	69c	12R8	.89	14W7	1.19	78	.78	125	125	125	450V	.49
6S6GT	69c	6S07GT	69c	12S8	.89	14X7	1.19	79	.79	126	126	126	450V	.49
6S7GT	69c	6S07GT	69c	12T8	.89	14Y7	1.19	80	.80	127	127	127	450V	.49
6S8GT	69c	6S07GT	69c	12U8	.89	14Z7	1.19	81	.81	128	128	128	450V	.49
6S9GT	69c	6S07GT	69c	12V8	.89	14A7	1.19	82	.82	129	129	129	450V	.49
6S07GT	69c	6S07GT	69c	12W8	.89	14B7	1.19	83	.83	130	130	130	450V	.49
6S1GT	69c	6S07GT	69c	12X8	.89	14C7	1.19	84	.84	131	131	131	450V	.49
6S2GT	69c	6S07GT	69c	12Y8	.89	14D7	1.19	85	.85	132	132	132	450V	.49
6S3GT	69c	6S07GT	69c	12Z8	.89	14E7	1.19	86	.86	133	133	133	450V	.49
6S4GT	69c	6S07GT	69c	12A8	.89	14F7	1.19	87	.87	134	134	134	450	

connections readily accessible without removing the chassis from the cabinet or turning the set upside down.

RESISTANCE SOLDERING

Vermaline Products Company, P.O. Box 222, Hawthorne, N. J. has developed a new resistance-type soldering unit, the Model 10.

Designed especially for production soldering of printed circuits, germanium diodes, and transistors, the unit is equipped with an adjustable heat control which prevents scorching of printed circuit plates. It is rated from 25 to 1000 watts.

A data sheet giving complete specifications on the Model 10 is available on request.

CARTRIDGE SELENIUMS

A new range of cartridge-type selenium rectifiers has been added to the "Seleton" selenium rectifier line by *Radio Receptor Co., Inc.*, 251 W. 19th St., New York 11, N. Y.

Included in the group are hermetically sealed glass-encased units, phenolic-encased half-wave axial lead units, and phenolic-encased bridge type and unmounted cells for special assembly.

A six-page data bulletin, No. 178, has been issued on these new units. It contains complete characteristics, reference curves, circuits, etc.

450-470 MC. GEAR

General Electric Company, Syracuse, N. Y. has announced production of new radio transmitter-receiver combination units for operation at recently authorized frequencies between 450 and 470 mc.

Designed for police and fire departments, taxicabs, and some industrial applications, the mobile models will function from either 6 or 12 volt batteries with no adjustments necessary

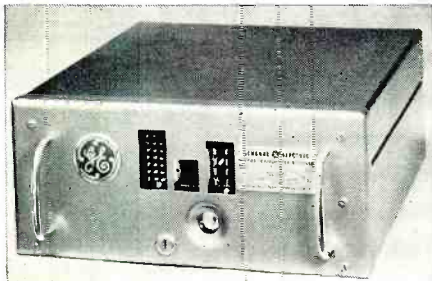

to revert from one to the other. Nominal output of mobile units is 20 watts. All station units have 40 watts output and are rated for continuous duty.

U.H.F. STANDOFFS

Television Hardware Mfg. Co., 919 Taylor Ave., Rockford, Ill. is now offering a completely new line of TV standoffs designed especially for u.h.f.

According to the company, the design permits their use with all kinds of lead-in line with particular emphasis on the newer hollow-core types. The "E-Z" standoffs are said to minimize the transmission loss from the antenna to the receiver. A new polyethylene insulator securely holds the lead-in

July, 1954

BUY DIRECT . . . and SAVE!

'PRE-FAB' COLLINS TUNERS

AUDIO PRODUCTS CO.

High Fidelity TUNERS and TUNER KITS

introducing the LATEST DESIGN

COLLINS CHROMATIC TUNER



CHECK THESE OUTSTANDING FEATURES

- 4 1/2" tuning meter. Each tuner calibrated in microvolts for direct reading of signal strength.
 - Not a kit. Completely wired, ready to use with FM antenna and amplifier.
 - Sensitivity 3 microvolts with 20 DB of quieting.
 - A.F.C. with disabling switch.
 - New, compact, low design. Only 5/4" high. Matches latest bookshelf amplifiers.
 - Voltage regulator tube for added stability.
 - Newly designed front-end using 6BQ7 tube.
 - Dual simultaneous audio output—high and low impedance.
 - Ultra wide range response, 20 to 25,000 cycles.
 - Distortion less than 3/4 of 1%. Hum 50 DB below program.
 - Beautiful golden brown metal cabinet completely enclosing tuner.
 - 5/4"x19" relay rack panel integral part of cabinet.
 - Twelve tubes.
 - Tone compensated volume control.
- Plus many other smaller features which make this tuner the hottest item since high fidelity!

Overall size: 19" W. x 5 1/4" H. x 8 1/2" D.

Shipping weight: 15 lbs.

\$97⁵⁰

COLLINS PRE-FAB KITS ALSO AVAILABLE

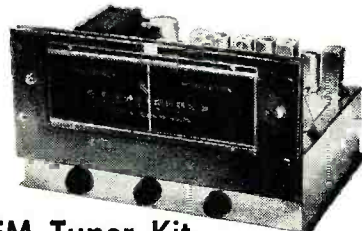

FM Tuner Kit

Shipping weight: 14 lbs. **\$55** with AFC **\$58.50**

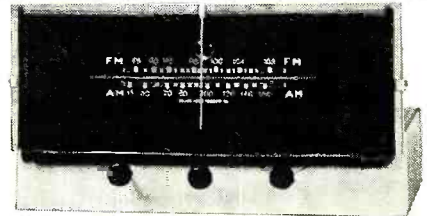

FM/AM Tuner Kit

Shipping Weight: 19 lbs. **\$77⁵⁰** with AFC **\$81**

IF-6 Amplifier . . .

6 tubes
Shipping Weight
3 lbs.

\$19⁷⁵

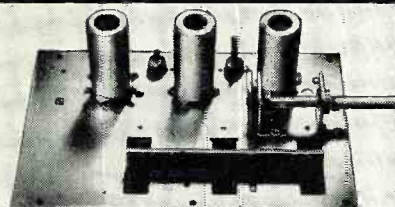

FMF-3 Tuning Unit

Shipping weight: 2 1/2 lbs. **\$15²⁵** with AFC **\$18.75**

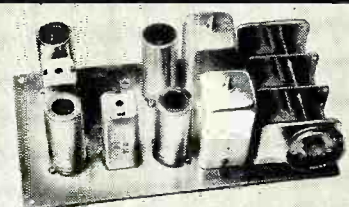

AM-4 Tuning Unit

\$24⁵⁰ Shipping weight: 2 1/2 lbs.

For Users of Collins Tuners:

Receive \$5.00 credit toward the new FMF-3A front end! Mail us your old front end with \$13.75 and we will send you the new, improved FMF-3A with AFC or, remit the full amount of \$18.75 and when we receive your old unit in return a check will be mailed you for \$5.00.

Collins Audio Products Co. is in no way affiliated with Collins Radio Co.

To: Collins Audio Products Co. Inc.
P.O. Box 368, Westfield, N. J. Dept. RN7
Tel. Westfield 2-4390

- Chromatic Tuner FM Tuner Kit FM/AM Tuner Kit
 with AFC with AFC with AFC
 IF-6 Amplifier AM-4 Tuning Unit FMF-3 Tun. Unit
 with AFC with AFC

Name

Address

City State

Amount for Kit \$ See weights, add shipping cost \$

Total amount enclosed \$ Check Money Order

Mail Coupon Today

WHEN YOU THINK OF TUNERS, THINK OF COLLINS AUDIO PRODUCTS

TELTRON TUBES

GUARANTEED! . . . LOWEST PRICES EVER!

All tubes individually boxed . . . unconditionally guaranteed for one year.

TYPE	PRICE	TYPE	PRICE	TYPE	PRICE	TYPE	PRICE	TYPE	PRICE
024	.45	6Q7	.40	6BK7	.78	6U8	.76	12K7	.40
1A7GT	.53	6AB4	.43	6BL7GT	.78	6U9	.80	12SA7GT	.45
1B3GT	.62	6AC7	.65	6BN6	.90	6V6GT	.48	12SK7GT	.45
1H5GT	.51	6AG5	.52	6BQ5GT	.83	6W4GT	.43	12SL7GT	.60
1L4	.51	6AH4GT	.65	6BZ7	.85	6W6GT	.53	12SN7GT	.56
1L6	.51	6AJ5	.96	6BY5G	.60	6X4	.37	12SQ7GT	.38
1LC6	.49	6AK5	.96	6BZ7	.95	6X5GT	.38	1986GG	1.48
1NSGT	.51	6AL5	.43	6C4	.41	6X8	.80	19T8	.71
1R5	.51	6AQ5	.48	6CB6	.51	7F8	.49	25BQ6GT	.82
1S5	.43	6AR5	.48	6CD6G	1.63	7N7	.49	25L6GT	.41
1T4	.51	6AT6	.37	6CU6	.95	12AL5	.43	25W4GT	.43
1U4	.51	6AUSGT	.60	6F6	.42	12AT6	.37	25Z5	.55
1U5	.43	6AU6	.43	6F5GT	.44	12AT7	.71	25Z6GT	.36
1X2	.65	6AV5GT	.60	6H6	.50	12AU6	.43	35B5	.48
2A3	.55	6AV6	.37	6AF4	1.02	12AU7	.58	35CS	.48
2A7	.35	6AX4GT	.60	6J5GT	.49	12AV6	.42	35L6GT	.41
3Q4	.53	6AX5GT	.60	6J6	.61	12AV7	.73	35W4	.33
3Q5GT	.61	6BA6	.56	6K6GT	.39	12AX4GT	.60	35Y4	.42
3S4	.48	6BA7	.58	6L6	.78	12AX7	.61	35Z5GT	.33
3V4	.48	6BC5	.48	6SA	.41	12AZ7	.65	50A5	.49
5U4G	.43	6BE5	.46	6SRGT	.65	12B4	.72	50B5	.48
5V4G	.49	6BF5	.48	6SA7GT	.45	12BA6	.46	50C5	.48
5Y3GT	.30	6BF6	.48	6SK7GT	.45	12BA7	.58	50L6GT	.50
5Y4G	.40	6BG6G	1.18	6SL7GT	.60	12B6	.46	Type 80	.40
5Z3	.42	6BH6	.51	6SN7GT	.60	12BY7	.65	117Z3	.33
6A8	.40	6BK6	.51	6SQ7GT	.78	12BH7	.61	117L6GT	1.20
6K7	.40	6BK5	.75	6T8	.31	12BZ7	.63	117Z6GT	.65

FREE \$7.20 list value Bonus Box of three 6SN7 tubes and 25 assorted resistors with each order of \$25 or more.

FREE GIFT OFFER One 6BGG tube will be shipped FREE with any order accompanying this ad.

We now have a complete line of special purpose and transmitting tubes in stock.

Write for quotations on your requirements—Dept. T.

We guarantee your orders to be shipped the same day they are received!

Minimum order \$10.00. 25% deposit on C.O.D. orders—save parcel post charges. Orders accompanied with full remittance will be shipped prepaid anywhere in continental U.S.A. All orders subject to prior sale.

Send for Free complete tube listing

SPECIAL!
while they last **29c** each 10 for \$2.50

Type	Type	Type	Type	Type
1A4P	1E7GT	19	34	37
1C6	1F4	1629	35	39/44
1C7G	1H4G	22	35/51	46
1D5GP	2A7	33	36	49
1D7G				1F5G

These specials are new, famous make, individually boxed. Order now.

TELTRON ELECTRIC COMPANY

428 Harrison Ave., Dept. RN7, Harrison, N. J.

Phone HUmboldt 4-9848

ENJOY 3 COLOR TELEVISION FILTER SCREEN NOW

Changes dull eye-straining black and white pictures into beautiful color tones. Seconds to attach. No tools used. Helps eliminate glare. Order direct. Send \$1 for screen size up to 16", \$1.25 size 17", \$1.50 size 20", \$2 size 21", \$2.50 size 24", \$3 size 27". (Also available are single solid color screens in blue, green, or amber.) Prices on solid color screens are 10% less. We pay postage except on C.O.D. orders. Satisfaction guaranteed. Inquiries from dealers also welcomed.

Zingo Products, Johnstown 19, New York



\$2.95 EACH OR 2 FOR \$5.00!

Genuine Telephone Company Upright Telephone complete with cords, in tested and guaranteed condition with 50 ft. of wire, roll of tape, inter-communication instructions. Tape and wire offer for this month only. Complete line of telephones, dial, magneto, inter-communication, etc. Write for free list. All shipments F.O.B.

TELEPHONE ENGINEERING CO.
Dept. 7-C4 Simpson, Pa.

without the need for metal encircling the wire. The insulator swings into position and locks into the metal bail through a unique hinging action. No pliers or special tools are required for installation.

NEW EXCITER

Central Electronics, Inc. 1247 W. Belmont Ave., Chicago 13, Ill. is offering a new exciter which has been tradenamed "Multiphase" Model 10B. The unit incorporates a new carrier

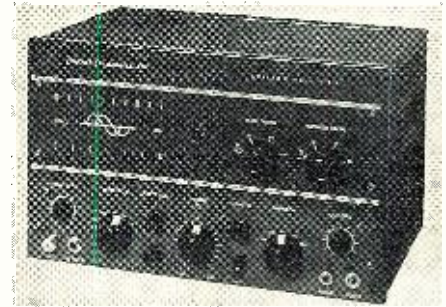

control which is adjustable from zero to full output, making it unnecessary to disturb the carrier null adjustments. It also contains a new a.f. input circuit for two tone tests or phone-patch input.

Peak output is 10 watts. Multi-band operation is provided from 10 to 160 meters using plug-in coils. It has voice-controlled break-in on single sideband, AM, and PM. Switchable single sideband, with or without carrier is provided. Suppression of unwanted sideband is 40 db or better.

VOLTAGE STANDARD

Sorensen & Co., 375 Fairfield Ave., Stamford, Conn. has developed a new tubeless a.c. voltage standard which is designed for calibrating meters and oscilloscopes.

The Model VRS-AC10 uses no tubes, is small in size and weight, and is extremely stable. Three ranges, 1 mv. to 100 mv.; 100 mv. to 1 v.; 1 v. to 10 v., are available at an accuracy of ± .25%. Output loading is 1 megohm or higher and the output may be shorted without damaging the instrument.

NEW PROBE LINE

Electronic Instrument Co., Inc., 84 Withers Street, Brooklyn 11, N. Y. is offering five new *Eico* instrument probes, three for scopes and two for v.t.v.m.'s.

The Model PD is for TV waveform tracing in low-Z or low-frequency circuits. The Model PLC is for TV waveform tracing in high-Z, high-frequency, or wideband circuits. The Model PSD demodulator probe increases scope usefulness so it can be used as a waveform tracer, gain analyzer, and alignment indicator in all TV, radio, r.f. and i.f. stages. The two v.t.v.m. models are the PTP-11 or 25 and the PRF-11 or 25. The first unit permits reading of peak-to-peak voltages directly on the d.c. scales while the second unit is for r.f. measurements up to 250 mc. —50—

Acrosound Ultra-Linear

TRANSFORMERS

for the ultimate in High Fidelity amplification

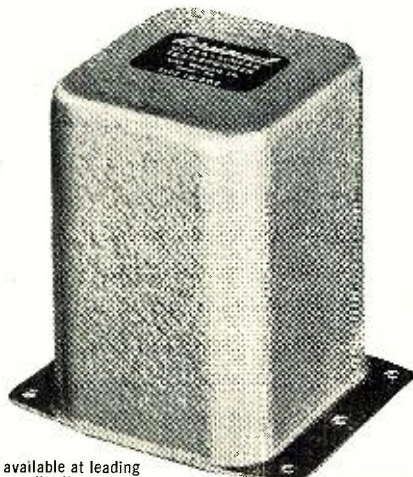

available at leading distributors

TO-300	for Ultra-Linear circuits with KT-66's, 807's, etc.	\$24.75 net
TO-310	for Ultra-Linear operation of 6V6 tubes	18.75 net
TO-330	for push pull parallel Ultra-Linear circuits	39.75 net
TO-350	for Ultra-Linear 100 watt amplifiers with 6146 tubes	49.50 net

Prices slightly higher in West
It takes more than a tapped output transformer to make an Ultra-Linear amplifier. It takes the exclusive patented Acrosound Ultra-Linear transformer designed for this application and crafted to the most rigorous specifications. Whether you build your own, convert an existing amplifier, assemble a kit, or buy a manufactured amplifier you can have genuine Acrosound Ultra-Linear circuitry, the finest available. Full transformer data and high fidelity circuits are available on request.

ACRO PRODUCTS CO., 369 Shurs Lane, Phila. 28, Pa.



BOOKS

Servicemen for Amateurs Experimenters

RADIO • T.V. • AUDIO • ELECTRONICS

New!

200. HOW TO USE SIGNAL AND SWEEP GENERATORS. By J. Richard Johnson. A practical handbook for the service technician, the radio amateur and the experimenter. Emphasis is on how to use the equipment, not on why it works. Lavishly illustrated, it gives test uses and discusses problems and their solutions in using this equipment. \$2.00

228. TELEVISION SERVICING. By Walter H. Buchsbaum. This gives clear simple instructions on the installation and maintenance of every type of TV receiver . . . shows you how to locate and repair every conceivable trouble a TV set can have . . . offers the latest information on the design and construction of TV receivers. It also devotes an entire, new chapter to color television, showing exactly how color TV receivers differ from black-and-white receivers. \$5.95

229. TECHNIQUES OF TELEVISION PRODUCTION. By Rudy Bretz. This is a comprehensive handbook for the studio engineer and technician, covering all of the equipment and materials used in producing television programs. It deals with the television cameraman, cameras, and camera handling; TV lenses; cutting; switching equipment; technical limitations and the production problems involved; graphic materials; projection equipment; mirrors and prisms; composite shots and the illusion of space; special effects with graphic materials; studio effects; electronic effects; television scenery, make-up, and lighting; audio problems in TV; and remote pickups. 464 pages. \$10.00

230. THE RADIO MANUAL, Fourth Edition. By George E. Sterling and Robert B. Monroe. No other single volume now available covers the entire field of radio so thoroughly—from elementary electrical and radio theory to the most advanced applications in AM, FM, and Television Broadcasting, Marine Radio, and Marine Navigational Aids, Emergency Services, State, Federal and International Laws. 820 pages. \$12.00

232. RADIO TROUBLE SHOOTING GUIDEBOOK, vol. 1. By John F. Rider and J. R. Johnson. A troubleshooting guidebook that covers AM, FM, troubleshooting, undesired signals, weak signals, distortion, noise, dead receivers. 140 pages. 5 1/2 x 8 1/2. Paper bound. \$2.30

205. HOW TO TROUBLESHOOT A TV RECEIVER. By J. Richard Johnson. A step by step guide for newcomers. \$1.80

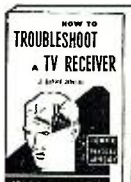

206. UHF TELEVISION ANTENNAS AND CONVERTERS. By A. Lytel. Latest information on all types, covers latest UHF installation techniques. \$1.80

233. TV TROUBLESHOOTING AND REPAIR GUIDEBOOK, vol. 2. By Robert G. Middleton. A gold mine of valuable TV service information. Troubleshooting front ends; Servicing the Video I-F strips; Faults in video amplifiers; Trouble analysis in sound I-F and detector systems; Practical pointers in audio amplifier servicing; Trouble in horizontal circuits. 160 pages. 8 1/2 x 11. Paper covered. Price \$3.30

234. THE RADIO AMATEUR'S HANDBOOK. Compiled by the American Radio Relay League staff. 800 pages, including catalog section. Price \$3.00

235. THE SATURDAY REVIEW HOME BOOK OF RECORDED MUSIC AND SOUND REPRODUCTION. By Edward Tatnall Canby, C. G. Burke, and Irving Kolodin. Here is complete, specific information on how to get the most out of improved equipment, how to choose among the wealth of new recordings offered, and how to get the ultimate in listening pleasure out of your collection. \$4.50

236. HEARING AIDS, THEIR USE, CARE, AND REPAIR. By M. Mandl. Provides information needed by users, prospective purchasers, dealers and servicemen. 90 illus. 153 pages. \$3.50

208. MODERN OSCILLOSCOPES AND THEIR USES. By Jacob H. Ruiter, Jr., 360 pages, 370 illus. \$6.00

211. INDUSTRIAL ELECTRONICS: An Introduction to Modern Industrial Electronic Practice. By Dr. R. Kretzman. \$5.50

224. RADIO DATA CHARTS. By R. T. Beatty. Charts required in the design of radio receivers cover such items as frequency, wavelength, inductance, capacity, frequency, self-inductance, r.f. coil windings, reactance of coils or condensers, transformer design, choke and transformer design. The only equipment necessary to utilize any of the nomograms is a straightedge. \$2.00

New!

4th Edition

225. TELEVISION SIMPLIFIED. By Milton S. Kiver. The most up-to-date, complete, and practical television handbook now available for repair men, radio workers and all who are interested in the practical opportunities a working knowledge affords. Basic principles are explained in language free of involved theory or mathematics—from the analysis of circuits and operating fundamentals of



frequency modulation to the repairing of television sets and the explanation of an actual troubleshooting system. \$6.75

226. TELEVISION AND FM RECEIVER SERVICING. By Milton S. Kiver. New, third edition of this famous definitive text. Explanatory material is offered freely so that the student or novice technician may derive maximum benefit from this text. Eighteen chapters cover antennas, TV receiver installation, TV test equipment, r.f. stages, video i.f. and detector stages, video amplifiers, and a.g.c. systems, CR picture tubes, servicing intercarrier receivers, using TV test patterns, deflection systems, etc. Service technicians who have come to depend on Kiver as reference will welcome this new volume. \$4.20

227. TELEVISION REPAIR MAN'S TUBE LOCATION GUIDE. By William Prior, Jr. Almost every known make of set including over 4000 models are covered with tube location diagrams. Put it in your service kit, in your shop, in the home. Only \$1.00

221. HIGH FIDELITY SIMPLIFIED, 4th Ed. By Harold D. Weiler. A non-technical explanation of hi-fi techniques and the necessary components which constitute a hi-fi system. Covers the latest tape recorders and the newest types of enclosures and speaker systems. 208 plates. \$2.50

222. HOME MUSIC SYSTEMS. By Edward T. Canby. How to assemble parts at greatest savings. \$4.00

223. HIGH FIDELITY HANDBOOK. By Greene, Radcliffe and Scharf. A virtual encyclopedia of step by step instructions, hundreds of diagrams that make it easy, inexpensive to select, install, assemble, and enjoy your own HI-FI system for records, tape, FM, AM, TV. Expert guidance in layman's language. \$4.50

New!

216. A GUIDE TO AUDIO REPRODUCTION. By David Fidelman. An A to Z explanation of the reproduction of sound. Discusses all phases of systems and requirements plus design, construction, assembly, and testing of systems and components. Explains in detail the circuitry of preamplifiers and amplifiers; complete discussion of phono cartridges, tuners, microphones, loudspeakers and enclosures. For the radio and TV service technician, engineer and experimenter. Companion volume to Weiler's High Fidelity Simplified. 250 pages. \$3.50



217. HIGH FIDELITY TECHNIQUES. By John H. Newitt. For the engineer, home builder of audio gear, service technician, studio personnel and professionals in the audio field. 12 chaps. in easy to read language. \$7.50

218. RECORDING AND REPRODUCTION OF SOUND, 2nd Ed. By Oliver Read. A complete presentation of the entire subject of sound. Discusses modern theory and methods used in the recording and reproduction of sound, based upon years of experience and research. Includes charts and Appendix. 810 pages. \$7.95

237. INTRODUCTION TO COLOR TELEVISION. By M. Kautman and H. Thomas. Discusses color wavelengths and frequencies; primary colors and circuits used in a color TV receiver and gives complete explanations as to their operation—setting up and adjustment procedure. \$2.10

238. HOW TO INSTALL AND SERVICE AUTO RADIOS. By Jack Darr. This book for service technicians discusses installation problems and special servicing requirements of the automobile radio. It gives information on antenna installations for the car, vibrator testing, noise suppression, and it furnishes a complete list of tools, spare parts, and other equipment needed to do auto radio repairing and servicing. \$1.90

239. HOW TO LOCATE AND ELIMINATE RADIO AND TV INTERFERENCE. By Fred D. Rowe. Both radio and television interference are discussed; why they occur and their solutions. \$1.80

FOR THE YOUNG READER

231. ALL ABOUT RADIO AND TELEVISION. By Jack Gould, Radio and Television Editor, The New York Times. The how and why of radio and television are explained clearly and directly in simple language and with over 100 illustrations and diagrams. It shows how a picture is changed into electricity, how to build a foxhole radio, why we have networks, how to communicate with the moon by radar. 160 pages. 6 3/4 x 9 1/8. \$1.95

When You Want a Book



Your Radio & TV News Book Service will attempt to procure any book in this field for you. Just send title, author and price.

MAIL THIS COUPON

NOW

**RADIO & TELEVISION NEWS BOOK SERVICE, Dept. R7
201 East 57th Street, New York 22, N. Y.**

I enclose \$ for which please ship postpaid books circled or indicated below. If not satisfied I can return them within 5 days for refund.

200 205 206 208 211 216 217 218 221 222 223 224 225 226
227 228 229 230 231 232 233 234 235 236 237 238 239

Any book not listed \$

Name

Address

City Zone State

ALL ORDERS SHIPPED POSTPAID. Sorry, no COD's. Add 3% sales tax with orders for N. Y. C. delivery; add 25¢ per title for delivery outside U.S.A., except for APO's.

TUBES		60% TO 90% OFF LIST!	TUBES	
OC3			471A	1.19
VR105	.80	6J6	532A	1.19
OD3		6K8	717A	.79
VR150	.85	6L6GA	722A	.99
1B22	.69	6L6M	801A	.19
1A7	.69	6N7	826	.39
1L4	.49	6S17	832A	6.95
2B22	.49	6SK7	836	5.50
2C26	.09	6SL7	837	1.35
2C26A	.09	6SN7	841	.29
2D21	1.19	6SS7	843	.19
2X2	.39	6SU7	844	.19
3B22	1.19	6Y8	931A	4.75
3D6	.39	7C4	1626	.19
5R4GY	1.15	12A6	1633	.19
5U4	.70	12AH7	2050	1.30
6AG5	.70	12AT7	2050W	2.35
6AK5	.75	12C8	59	5.664
6AK5W	1.45	12H6	55	5.670
6AL5	.49	12L8	29	5.726
6AL5W	.75	12SH7	75	5.749
6AQ5	.52	12SJ7	59	5.751
6AS6	1.90	15Z	54	5.814
6BA6	.54	28D7	39	6.096/CT
6BE6	.54	39/44	1.50	7.193
6BQ6	1.15	114B	29	9.002
6C4	.50	215A	29	9.003
6D4	2.50	221A	09	E1148
6H6		316A	29	RE34
6J4	4.25	388A	29	VR32
			59	VT127

SCOTCH BRAND
SOUND RECORDING TAPE
111A
1200 feet (List Price \$5.50)
SPECIAL \$2.99



SCR-274N
COMMAND
and
ARC-5
EQUIPMENT

RECEIVERS	USED	EXCELLENT USED	NEW
BC-453—190 to 550 KC.....		\$24.95	\$49.95
BC-454—3 to 6 MC.....		14.95	24.95
BC-455—6 to 9 MC.....		12.95	18.95
1.5 to 3.....			29.95

TRANSMITTERS	USED	EXCELLENT USED	NEW
A-958—2.1 to 3 MC.....			24.95
BC-457—4 to 5.3 MC.....		12.95	
BC-458—3.3 to 7 MC.....		12.95	
BC-459—7 to 9.1 MC.....	\$8.95		24.95
T-15 ARC 5—500 to 800 KC.....			24.95

ADDITIONAL EQUIPMENT

BC-456 Modulator.....			6.25
BC-450 Control Box (3 Receiver).....		1.95	2.58
BC-451 Control Box (Transmitter).....	1.29	1.79	2.49
BC-442 Relay Unit (ANT).....			5.49
Flexible Shafting with gear to fit receivers.....			1.95
3 Receiver Rack.....	1.79	2.29	2.98
Shock Mount for Receiver Rack.....		1.25	
2 Transmitter Rack.....		2.39	3.95
Single Transmitter Rack.....			3.49
DM-33 Dynamotor for Command Set.....			3.95

BC-221 Frequency Meter
Real Value! QUANTITY IS LIMITED
—so first come, first served. They are just like new, with original calibration charts. Range 125-20,000 KC with crystal checked points in all ranges. Complete with crystal and tubes. **\$139.50**
Standard with AC power supply..... \$159.50
MODULATED TYPE..... \$179.50
MODULATED TYPE with AC Power Supply..... \$199.50
Limited quantity of BRAND NEW MODULATED FREQ. METERS..... \$210.00
These Frequency Meters are factory treated, checked for frequency alignment and GUARANTEED.



HEADSETS

HS-23 high impedance. BRAND NEW with ear pads.....	\$4.65
HS-33 low impedance. BRAND NEW with ear pads, cord and PL54 PLUG.....	5.65
HS-33, used.....	1.89
CD-307A Cords, 6 ft. NEW.....	\$1.49
HS-16 high impedance—used.....	.95



MICROPHONE SUPER-SALE

T-44 MIKE—magnetic type consisting of Mike Unit MC-253, Cord CO-287, Plug PL-179 and Jack JK-26.....	\$1.29
T-45 MIKE—Carbon Lip Mike.....	1.95
T-17 MIKE—Carbon—BRAND NEW.....	9.75
TS-13 HANDSET—BRAND NEW.....	7.95
T-12—Western Electric Carbon Hand Mike with Cord & PL-68 Plug. BRAND NEW.....	3.95

TAKE YOUR PICK FROM THESE BARGAINS!
CRYSTALS for the BC-458 Command Transmitter, plug-in type, 6200 KC, BRAND NEW..... \$1.95
Complete set of COILS for BC-458 Command Trans..... 3.95

SAVE! SAVE! SAVE!
SCR-522 RECEIVERS
less oscillator assembly, frequency shifter and tubes. Contains all Coils, Transformers, Resistors, Condensers and other valuable parts. **\$5.95**
SPECIAL! 2 for \$10.00 each

MINIMUM ORDER \$2.00
Immediate delivery—send 25% deposit on C.O.D. orders. If sending full remittance, allow for Postage and save C.O.D. charges. All shipments F.O.B. N.Y.C. warehouse. (N.Y.C. residents add sales tax.)

PLATT ELECTRONICS CORP.
Dept. A, 489 Broome St., N. Y. 13, N. Y.
PHONES: WO 4-0827 and WO 4-0828

A Bass-Boost Control

(Continued from page 53)

system without appreciable loss of high-frequency response. If this amplifier is to be mounted within one or two feet of the power amplifier, the cathode follower, V_2 , can be omitted from the circuit. The output could then be taken from C_{17} , resulting in fewer parts and a smaller amplifier.

The bass-boost control consists of a *Centralab* type 1402, which is an 11-position, single-section, shorting-type switch, small enough to fit into a two-inch-deep chassis. A shorting-type switch is necessary in order to prevent clicks when the control is turned. The original screws were removed from the switch and two 6-32 round-head machine screws, two inches long, substituted for them. Two one-inch spacers were used to mount a *Cinch-Jones* type 2004 4-point terminal strip on the rear of the switch. The condensers were then mounted between the switch terminals and the terminal strip which is connected to ground.

This bass and treble boost control can be added to the input of an existing amplifier if desired, instead of building the complete amplifier shown here. The parts included within the dotted lines should be wired into the amplifier in the same manner as shown in the circuit of Fig. 3. If the treble boost control is not required, R_2 can be changed to a 470,000-ohm, $\frac{1}{2}$ watt resistor and R_1 and C_{11} eliminated from the circuit. The grid of the tube in that case, should be connected to the junction of R_2 and R_3 .

As the control introduces a loss of 23 db at 1000 cycles, this much additional voltage gain must be available if it is incorporated into an existing amplifier. If this gain is not available then it is advisable to build the complete amplifier shown in Fig. 3.

Fig. 1 shows the underside of the amplifier as built by the author. As a 5" x 7" x 2" chassis could be easily fitted into the cabinet used, there was no need to make the amplifier compact. The treble-boost control, R_2 , is mounted in the center of the front drop of the chassis, and the volume control, R_1 , is mounted to the right. The placement of the other parts can be readily determined from the photograph.

In the installation for which this amplifier was built, 18 volts of d.c. was available for heater supply, so the heaters of the 12AU7 and the 6C4 were connected in series. The use of d.c. made it possible to eliminate cathode bypass condensers C_{12} and C_{16} and to run unshielded leads in the chassis. The polarity of the heater supply is not important and either side can be connected to ground. If the heaters are to be operated on a.c., it will be advisable to include C_{12} and C_{16} in the circuit and to shield the leads from the input jack, J_1 , to R_2 and those from R_2 to R_4 , in order to reduce

hum to a minimum. The heaters, of course, should be connected in parallel. R_{15} acts as a hum-balancing pot when a.c. is used. If the 6.3-volt winding of the transformer in the supply to be used with this amplifier is connected to ground or to a bias voltage, this connection must be removed to prevent R_{15} from being shorted out. R_{19} and R_{17} make up a voltage divider across the 300-volt supply to furnish a 45-volt positive bias on the heaters. C_{19} is a bypass condenser to keep the heaters at ground potential at audio frequencies.

A 5" x 7" bottom plate should be used to complete the shielding of the chassis.

The plate power requirements are 6 milliamperes at 300 volts. This can be obtained from the supply for the power amplifier and should be well filtered.

Although the conventional bass-boost control is simpler in design, this improved unit, by its performance, amply compensates the builder for the few additional parts required. —50—

P.A. Rentals

(Continued from page 51)

number of years. Race tracks, football and baseball stadiums, and other seasonal operations are often customers for this rental-purchase plan.

Periodic disposal of equipment at substantial price reductions benefits both you and your customers. This way you may keep your rental equipment up-to-date and your customer gets good equipment at wholesale or below wholesale prices. In many cases you will be able to give a "new equipment" guarantee, otherwise the units can be sold "as is."

You may wish to bolster your commercial sound equipment with a line of high-fidelity audio products for home installation. A nearby interior decorator and cabinetmaker may wish to join you in a venture to design, build, and install high-fidelity equipment. Servicing such equipment can be a very profitable venture especially in metropolitan areas where hi-fi is booming.

On the assumption that it is better to work with your competitor rather than against him, you might find it mutually advantageous to lend (or rent at low cost) equipment to each other on jobs that are so large that either of you don't have enough equipment individually to handle the job. Or, on certain occasions, a joint venture may be profitable. Under these circumstances it is best to have only one of you make the agreement and arrangements with the customer as he may lose confidence in you if he feels you need help and it is easier for him to deal with only one agency.

There are so many facets to this world of sound that you will undoubtedly run across many angles that may transform what originally was a sideline into a full-fledged and booming business. —50—

Pioneer Amateur Station
(Continued from page 34)

what this spark sounded like on the air is hard to describe. It was generated by gas explosion and fluid flow return, and it sounded just like that. The nearest thing today is a loose wire in a pole transformer. It defies any other comparison. But we were on the air with "power."

The summer of 1912 found us in Philadelphia one day listening to a receiver with a galena (lead sulphite) crystal detector, and we got a piece to try. It worked better than the old electrolytic detector, but "setting" the "catwhisker" on a sensitive spot was a job until we learned to judge the degree of sensitivity from the pickup of a buzzer spark.

In the fall of 1912, with the messy acid of the electrolytic detector removed from the picture, the receiver was built into a cabinet. The detector and condenser switch was placed on the top and the slider operated by pulling out a knob on the end of the cabinet. This cabinet receiver survived the years, and is shown in Fig. 4. The circuit is identical with that shown in Fig. 1 with the galena crystal substituted for the electrolytic detector.

A natural question at this point is, what distance did this equipment cover? The battery-operated coil first used was of course local, not over 10 miles range, and when the power line was connected the distance was extended to occasional contacts up to 150 miles. The receiver brought in many stations up and down the coast from Boston to Key West, and many inland stations of the day. Its range depended on atmospheric conditions, as is the case with today's receivers. At night, stations all around the Great Lakes were clearly heard in West Chester.

Another question often asked: "What frequency (wavelength) did you use?" The most accurate answer is "Don't know." The only thing we had to go by

was the publication, from time to time, of technical articles stating that a coil and condenser of given dimensions would give you 200 meters or 300, as the case might be. No such thing as a wavemeter (frequency meter) or standard frequency signal existed outside of government bureaus and a few of the larger laboratories. With these given coils (helix) and condensers, all an amateur could do to tune his transmitter was to insert a flashlight bulb in the antenna lead, and keep moving clips on the helix until the bulb was lighted to maximum brilliancy. That, in the early days, became your working frequency. Naturally much interference with commercial services and the Navy resulted.

Much was written in the early 1920's when spark was ruled off the air about its broad tuning, and this referred to well constructed commercial transmitters as well as home-built jobs like ours. Within five miles of our direct-coupled spark, any reception below 500 meters was purely accidental.

In 1916 the author took the examination, got a license, and the call "3BV" was assigned. At the same time a "loose coupler" or receiving transformer was purchased, together with a *Murdock* .001 μ f. variable condenser, a *Turney* "Crystaoli" detector and a pair of *C. Brandes* "Navy" model headphones. Fig. 5 shows this new apparatus, our first factory-made gear, and the old receiver as set up at the time (1916). The new receiving apparatus was a marked improvement over the old single slide tuner, the individual tuning of the antenna and detector circuits nearly doubled the signal strength. Also the secondary of the loose coupler would slide out of the primary, sharpening the tuning. The *Murdock* variable condenser was shunted across the secondary of the loose coupler and gave the final touch to the close tuning of any station heard.

The really novel feature of this loose-coupled receiver was the "Crystaoli" detector. A galena crystal was mounted inside one end of the hub of a



NOW COYNE TRAINS YOU IN SPARE TIME AT HOME

TELEVISION RADIO-ELECTRONICS

Only from famous COYNE do you get this modern up-to-the-minute TV Home Training. Easy to follow Step-by-Step instructions—fully illustrated with 2150 photos and diagrams. Not an old Radio Course with Television tacked on. Personal guidance by Coyne Staff. So practical you can quickly EARN MONEY IN A TV-RADIO SALES AND SERVICE BUSINESS—part time or full time. Not only FINEST TRAINING but COSTS MUCH LESS—pay only for training—No costly extras.

SEND COUPON for DETAILS FREE
SEND COUPON BELOW for Picture Folder and full details including EASY PAYMENT PLAN. NO COST OR OBLIGATION—NO SALESMAN WILL CALL.



B. W. COOKE, Pres. **COYNE ELECTRICAL SCHOOL** FOUNDED 1899

A TECHNICAL TRADE INSTITUTE CHARTERED NOT FOR PROFIT
500 S. Paulina Dept. B4-HT5 Chicago 12, Illinois

B. W. COOKE, President
COYNE ELECTRICAL SCHOOL
500 S. Paulina St., Chicago 12, Ill., Dept. B4-HT5
Send FREE Picture Folder and details of your Television-Radio-Electronics Home Training offer.

Name.....
Address.....
City..... State.....

URGENT! URGENT!

ELECTRONIC TUBES

We Pay Spot Cash for:
RADIO, TV -all types
State types, condition
of merchandise, quantities and price.

COLUMBIA ELECTRONICS CORP.
115 Liberty Street, N. Y. C.

ULTRA LOW LOSS DESIGNED FOR HIGHEST UHF GAIN

DON'T RUIN your installation with a lightning arrester of high insertion loss. Install the arrester that's an asset instead of a liability to your UHF or VHF installation—the JFD "3-IN-1" with the ultra low loss compensating coil circuit. Thousands of installations prove the "3-IN-1" gives the lowest insertion loss of any arrester in use today. Patented strain-relief lips and patented saw-tooth washers are exclusive JFD extras at no extra cost.

Write for Form 210.

No. AT110 with hardware for wall or window sill.....\$1.50 list

No. AT110S with UL approved stainless steel mounting strap.....\$1.75 list

U. S. Patent Nos. 2,654,857; D-159,330

3 in 1

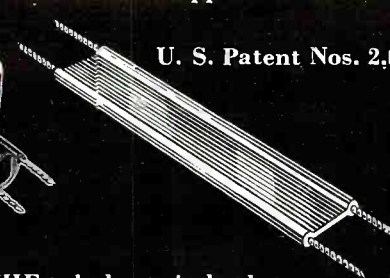

LIGHTNING ARRESTER

JFD MANUFACTURING CO.
BROOKLYN 4, NEW YORK

1 For all UHF or VHF tubular twin leads

2 For VHF flat twin leads

3 For UHF-VHF open wire

NOW- STEP AHEAD FASTER! AS AN INDUSTRIAL ELECTRONICS TECHNICIAN

Turn your experience into a
big, new, better-paying career!

Day by day industrial plants are adding more electronic devices — for sorting, counting, checking, almost any control job you can name. Cash in on industry's great need for men who can keep these devices in top working order. Make more money, feel more secure, doing work that is second nature to you. With what you already know about electronics you have a long head start in a field just beginning to boom. GET INTO IT RIGHT NOW with the help of

PRACTICAL INDUSTRIAL ELECTRONICS LIBRARY

4 Volumes
1390 pages
1050 illus.

\$22.50
EASY
TERMS

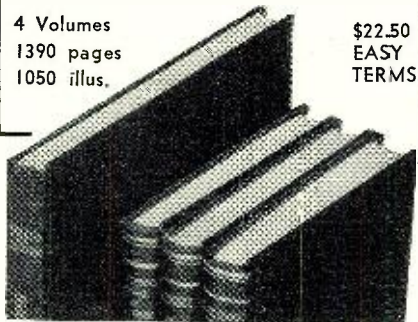

Here's the practical kind of information these 4 volumes give you:

- How to keep the plant's electronic equipment performing as it should
- How to locate and correct tube and circuit troubles quickly and easily
- How to install, service, and maintain even brand new equipment without being stumped by new circuits

No long sessions on math or theory! Instead you get: Clear explanations of how tubes and tube-operated circuits work in motor controls, welding controls, heat controls, etc. A complete manual that covers all maintenance procedures. A handbook of 433 industrial electronic circuits with each fully described. Troubleshooting charts, tested working methods, step-by-step directions—everything you need to start right now is here.

Contains

Chute's Electronics in Industry
Miller's Maintenance Manual of Electronic Control
Markus & Zeluff's Handbook of Industrial Electronics Circuits
Henney & Fahnestock's Electron Tubes in Industry

- Shows facts such as:
- How to operate the vacuum-tube voltmeter
- How to correct ignitor misfire
- How to maintain light sources for photoelectric control
- How to protect circuits of welding machines
- How tubes serve in conveyor synchronization, color measurement, etc. and hundreds more

FREE TRIAL—EASY TERMS

McGraw-Hill Book Co., Dept. RTN-7, 327 W. 41 St., NYC 36

Send me the Practical Industrial Electronics Library for 10 days' examination on approval. In 10 days I will send \$2.50, then \$4.00 a month until \$22.50 is paid. (A saving of \$3.50 under the regular price of \$26.00.) Otherwise I will return books postpaid. (Print)

Name

Address

City Zone State

Employed by

This offer applies in U.S. only. RTN-7

small rubber disc, the opposite end of the hub being closed with a metal plug. The space between was partially filled with metal filings. This detector was "set" by slowly revolving the disc in its clips while the spark from a low frequency buzzer "cohered" the filings when a sensitive spot was found. This was by far the best crystal detector up to that time, and because of its shock-proof mounting, often stayed in adjustment for a week or more.

The station remained more or less like the photograph of Fig. 5 until closed down for World War I in 1917. The author went to sea in radio during that affair and in September 1919 opened up 3BV again. This station (Fig. 6) is the same loose-coupled, "Crystaoli" detector receiver used before the War. We had worked large sparks during the War and learned something about them. A *Murdock* oscillation transformer was purchased and a rotary spark gap made. However we still had d.c. power, so had to continue the use of the electrolytic interrupter and spark coil. A *Roller-Smith* hot-wire ammeter was added to measure antenna current.

Now we were really "in business" with over 3 amperes of antenna current, the transmitter inductively coupled to the antenna, and sharp as a razor on 200 meters. We got little benefit from the rotary spark gap as the modulation of the interrupter came through and the resultant note sounded like a buzz saw striking a nail in a log. Fig. 7 shows this transmitting apparatus, now mounted in a display case, in much better detail than the general station picture.

By June 1922 the station had been completely rebuilt as far as receivers go; the vacuum-tube detector and amplifier connected through switches to a honeycomb coil receiver for long-wave, and a variometer inductively-tuned receiver for amateur and broadcast, had replaced the old loose-coupled receiver. The same old spark had been placed on the floor at the end of the table. All of the apparatus shown in Fig. 8 was home-made and was described in detail in various early issues of *RADIO NEWS* in 1921 and 1922.

At the beginning of 1923, the real active days of the 3BV spark ended. Shortly after the picture (Fig. 8) was taken, a.c. power became available and a 1 kw. transformer was installed. With the rotary gap it produced a wonderful musical note on the air, but by this time the need for earning a living brought the writer to Savannah, Ga. as radio supervisor of the U. S. Shipping Board. After a year or so, the YL became the OW (we were plain-spoken in those days), and we started up in Savannah as 4EO-4ZD-4XX.

The first Savannah station (Fig. 9) was on the air late in 1923, first as 4EO and then as 4ZD and combined with the 4XX commercial experimental station license. This station was a 100-watt Hartley oscillator c.w. transmitter on the new short-wave (high frequency) bands. Plate supply was 1200

volts d.c. from motor generators. The receiver was a honeycomb coil affair with one stage of r.f., and was written up in the July and October 1924 issues of *RADIO NEWS*. The transmitter was housed in the cabinet supporting the loudspeaker, the receiver in the center of the large cabinet with a Grebe detector, and two-stage audio amplifier in the right compartment.

The "X" license in those days was granted for serious experiments with short-wave (high frequency) transmissions. Generally, any wave below the 200 meter point was allowed, and most of the stations at the time gravitated to wavelengths between 75 and 110 meters. The basic reason for this selection was that available parts were not capable of withstanding the higher frequencies. Condensers, for example, of "good" quality, just burned up. We worked a lot of foreign countries and had many good U.S. contacts as well.

Late in 1924 found the family moving into their own house in Savannah where there was plenty of space for a radio room, so the station shown in Fig. 10 was set up.

The transmitter was a rebuilt version of the previously-mentioned 100-watt Hartley, remodeled to get down to 20 meters. With more room, better parts, and ventilation it worked much better. To describe the station, Fig. 10, let us start with the transmitter on the right end of the table, next comes an old Navy CM 294 receiver for low-frequency work, next a short-wave regenerative receiver, and on the left end of the table is the large panel of a 10-tube superheterodyne receiver made from a BCL failure of the early days. Plug-in coils gave a range from 20 to 800 meters, with one stage of r.f. ahead of the first detector. The circuit of this receiver is shown in Fig. 12. This receiver was the result of toying with the idea that Armstrong's superheterodyne would someday be the ultimate in all receiver fields. It cost a small fortune to develop this from a complete failure. Little or nothing had been published about what the big companies were doing with superhets, although it was a well-known fact that they were working on them. In this case results, then and now, have more than justified the time and money spent on this receiver.

In 1927 a move from Savannah to the North was necessitated by our getting involved in radio compass work through the superhet development. Most of the next few years were spent traveling, so that there was no more time for amateur radio. We had a try at manufacturing quartz crystals in the early days in Savannah, and got into the design of modern transmitters using crystal control in their oscillators. We had to face it, amateur radio was over for us.

What had been accomplished with all this expenditure of time and money? We were established in radio compass work as a result of the superhet, and magazine articles had paid for most of the things they described. What was

accomplished technically in the way of advancement can be partially measured by a comparison of Fig. 11 and Fig. 12 as far as receivers go. Transmitters advanced from plain open untuned sparks to excellent c.w. and phone units. Possibly the most important of all, as a group, amateurs proved that the band below 200 meters, assigned to them originally because it was believed of no value to commercial or military services, was in fact the most valuable band in the spectrum. -30-

PIONEER "BROADCAST"

By CHARLES G. COOKE
Life Member, V.W.O.A.

HERE is the story of what was probably the first instance of music being broadcast by wireless.

It was in the spring of 1906 and the "USS Illinois" to which I was attached as wireless operator had just returned with the Atlantic fleet from winter maneuvers in the Caribbean to Hampton Roads, Virginia.

I was on wireless watch using an electrolytic detector when I heard a spark changing its pitch to play what was clearly the first line of "Home Sweet Home".

Amazed and curious, I began a round of visitations to the wireless offices of the other ships in the fleet.

Finally, I found on the "USS Missouri" an ingenious operator with an 80 volt d.c. generator feeding a large spark coil primary through a mercury-turbine interrupter driven by a small motor, the speed of which was governed by a sliding rheostat which had been calibrated C, D, E, F, G, A, B, and C.

Thus it was only necessary to push the rheostat slider to the desired note, wait for the speed to stabilize, and push down the key.

You should remember, however, that in those days there were no wireless traffic controls, no interference, and the sky was the limit on jabber. -30-

SOMETHING NEW IN ELECTRONICS

to be announced
in August

RADIO & TELEVISION NEWS

POPULAR ELECTRONICS

POPULAR ELECTRONICS

POPULAR ELECTRONICS

watch for August

RADIO & TELEVISION NEWS

July, 1954

New SURPLUS AT NEW LOW PRICES

SINGLE SIDE BAND I.F. FORMERS

APC Capacity tuned interstate I.F. Transformer peaked at 1625 KC. Litz wire wound on powdered iron core with silver mica coupling. Condenser excellent for Crystal or Mechanical filter for single side band. All NEW \$1.50 Ea.

FLUORESCENT FLOODLIGHT

This unit uses 6 15 Watt fluorescent bulbs in parallel on 115 V., 60 Cy. AC. Unit measures 21" x 21" x 4" and weighs approx. 30 lbs. Will make an ideal Bench Light, Garage Light, or use 2 or more for photographic floodlights. These units are all NEW. This is a \$75.00 Value, priced specially low less tubes with starters and ballasts..... \$14.95 Ea.

RADIOSONDE UNITS

Type AN/AMQ-1. Used by weather stations. Unit is sent into air on balloon to transmit information on temperature, moisture and barometric pressure to the ground. All New..... \$4.94 Ea.

304 TL TUBES

High Power Triode. Bulk Packed. All Checked. Special..... \$3.95 Ea.



Thousands! CRYSTALS Thousands!

FT-241 54th Harmonic Type. Fundamental Frequencies listed below in KC.

370	390	410	430	449	469	486	508
372	392	412	432	451	471	488	510
374	394	414	434	453	473	490	512
376	396	416	436	454	474	492	514
378	398	418	438	457	477	494	516
380	399	420	440	458	477	496	518
382	400	422	442	460	479	498	520
384	402	424	444	462	480	502	
386	404	426	446	464	482	504	
388	406	428	447	466	484	506	

Each Frequency..... 6 For \$1.00
500 KC..... 1.25



SOUND POWER HANDSETS

Use these phones without any external or internal voltage supply. Two or more can be used with only 2 wires interconnecting them. Use for TV installation, house to house or house to garage. All new..... Per Pair **\$18.95**

FIELD TELEPHONES

EE-8 Type. Uses 2 1 1/2 V. Flashlight Batteries for Power. Transmits over wire up to 10 miles, with Magneto Ringer. In Leather Case. In excellent Condition..... \$32.50 Per Pair

HEAD SETS

High Impedance R-14 Phones 8000 Ohm. For all standard Radio Output Circuits. All New..... \$2.50 Ea.

TRIPODS

Heavy Duty 4 Ft. Adjustable Log Wood Tripod with 5/16" Diameter. Brass Mounting, Plate and Screw. All New..... \$4.95 Ea.

BC 375 TUNING UNITS

TU-26 (200-500 KC), TU-7 (4500-6200 KC), TU-8 (6200-7700 KC), TU-9 (7700-10000 KC), All with Vernier Dials, and Many useful parts. All used..... Low Priced @ **\$1.50 Ea.**

POLE CLIMBERS AND BELTS

Telephone Type Climbers with Leather Leg Straps. Used, Excellent Cond. Pair **\$2.95 Ea.**
Safety Tool Belts. Leather, to use with pole climbers. Used, Excellent Cond. \$3.50 Ea.

SELSYN MOTORS

Type 5F Synco Motors, used in pairs for remote tuning or remote position indicators. 115 V., 60 Cy. operation. Size 3 1/4" Diam. x 5 1/4" long. All New..... \$35.00 Pair

SPECIAL A.C. MOTORS

1/40 Horse Power Bodine Sync. Motor, 1800 R.P.M. Operates on 110 V., 60 Cy. Has 2 shafts and fan type flange mount. Uses 5 Mfd. Capacitor for starting. Used for Fan, or small Grinder, Buffer or Hobby work. All in excellent condition. Ea. **\$7.95**
Capacitor..... Ea. **\$1.00**

MIDGET SELSYNS

AY6 type operates from 6-12 Volts 60 Cycle. Use as both transmitter and receiver. These compact little units draw almost no current and work fine for all remote position indicating applications. OD 2 1/4" x 1 1/2" x 2 1/2". Has spring return shaft. All New (Appr. wt. 1 lb.). Each **\$1.95**



ARMY AMMUNITION CANS

Type M-3 50 Cal. Cans 12" Long x 6" Wide x 7 1/2" Deep.
Type M-1 Cans 16 1/2" Long x 3 1/2" Wide x 6 1/2" Deep.
All aluminum with Leather Handle and Hinged Top with hasp. Use for all your small parts or tools. O.D. Color, clean them and buff or paint. Each **\$1.50**



PROP PITCH MOTORS

For your Beam Antenna: 20 Volt to 32 Volt. A.C. or D.C. Motor: 1 1/4 RPM Gear. All brand New. 1/2 H.P. as above. **\$16.95 Ea.**

CRYSTALS

DC-34 and DC-35, 3/4" Spacing									
1690	2050	2280	2467	2711	2980	3540	3870	4050	
1705	2075	2295	2478	2725	3000	3575	3885	4055	
1720	2082	2300	2491	2732	3010	3600	3890	4065	
1738	2090	2315	2500	2745	3023	3615	3895	4085	
1746	2105	2326	2510	2764	3027.5	3625	3905	4090	
1770	2106	2335	2514	2775	3055	3702.5	3920	4150	
1790	2131	2340	2527	2776	3077.5	3705	3925	4175	
1810	2155	2355	2540	2807	3095	3730	3935	4177.5	
1830	2175	2360	2586	2816	3117	3765	3940	4210	
1850	2195	2375	2587	2831	3149	3769	3950	4215	
1870	2202	2380	2599	2851	3161	3770	3965	4240	
1890	2215	2395	2605	2863	3190	3317	3775	3985	4305
1910	2220	2415	2625	2894	3201	3345	3790	3995	4325
1930	2235	2422	2643	2895	3227.5	3365	3792.5	4012.5	4345
1970	2240	2435	2665	2899	3270	3395	3807.5	4015	4380
1990	2255	2440	2670	2925	3279	3412	3825	4020	4440
2010	2258	2446	2685	2926	3297	3412.5	3830	4030	4745
2030	2275	2458	2710	2960	3311	3462	3855	4035	

PRICE 85¢ Ea. 6 For \$4.50,
SHIP BAND FREQUENCIES 2142, 2174, 2638,
2670 \$2.00 Ea.

12 VOLT DYNAMOTOR

PE-55 Power Pack. Complete New Unit with DM-19 Dynamotor, Filter and Relay Base. Continuous Ratings, 500 V. @ 200 MA output or intermittent 500 V. @ 400 MA. These are all NEW in original cases. **\$17.95 Ea.**

RM-29 FIELD PHONES

Remote control unit for Transmitter or Receiver which can be used in pairs over wire with intercom. 4 1/2 V. battery as field telephones. Enclosed in a metal case and with a canvas carrying bag. Ideal for House to Garage or Intercom. All New less handset @ \$3.95 Ea. \$16.95/Pr.

PE 104 VIBRATOR POWER SUPPLY

Part of BC-654 Transformer, Input, 60 R 12V.D.C. Output, 6, 14 and 84 U.D.C. Pos. 1.4, 8, 12 and 31 V.D.C. Neg. In excellent condition. \$8.95 Ea.

12 or 24 VOLT VIBRATOR INVERTER

Use for Mobile Radio, Trucks, Buses, etc. with 110 Volt, 60 Cycle is desired. Can be used on 12 Volts or 24 Volts D.C. input, 110 V., 60 cycle, 240 watt maximum output. Uses separate vibrator for each input voltage. In enclosed case, **\$27.50**

HEAVY DUTY 12 VOLT BATTERIES

Thor-12 VOLT 220 AMP. HOUR Battery. Use for Trucks, Buses, Mobile Radio. All New. Dry Charged \$29.95 Ea.

Willard or Prestolite 12 VOLT, 68 AMP. HOUR Battery. Use for planes, cars or Mobile Radio with Spill-proof Caps. All New, Dry Charged. \$14.95 Ea.

RADIO DIRECTION FINDER

RC-1003 Receiver. Frequency Range 100 KC-1000 KC in 3 bands. Has Loops mounted on top with Sine and Balance Circuits. Less power supply. In Exc. Cond. with Tubes \$49.95 Ea.
12 V. Input Dyn. for above Receiver. \$6.95 Ea.

MICA CAPACITORS FIG. A UPRIGHT MOUNTINGS

MFD.	Ea.	MFD.	Ea.	MFD.	Ea.
1000 V.					
.1	\$1.00	.025	2.25	.00006	.95
.02	.90	.0075	1.50	.00005	.95
.062	.90	.0006	1.50	.004	5000 V. 3.50
.05	.85	.00025	1.25	.002	3.25
1500 V.					
.075	1.25	.006	1.50	.001	3.25
.05	1.20	.004	1.50	.0008	3.25
.039	1.10	.004	1.50	.00075	2.75
.03	1.00	.003	1.50	.00045	2.35
2000 V.					
.03	2.25	.00625	1.35	.0002	1.75
.01	2.00	.00055	1.25	.00009	1.50
.006	1.50	.0005	1.25	7500 V.	
.005	1.50	.0004	1.25	.0005	3.95
.003	1.25	.00025	1.25	8000 V.	
.00275	1.25	.0001	1.00	.01	5.95
.0025	1.25	.00009	1.10	.0006	4.50
.00125	1.00	.00008	1.00	.0005	4.50
.00003	1.00	.000075	1.00	.00025	3.95

FIG. B SCREW TERMINAL

MFD.	Ea.	MFD.	Ea.	MFD.	Ea.
500 V.					
.05	1.00	.022	.85	.015	1.60
.04	.85	.02	.85	.01	1.50
.02	.75	.01	.85	.0075	1.25
600 V.					
.01	.65	.005	.50	.002	1.00
.047	.85	1250 V.		.0018	1.00
.03	.75	.03	.95	.0006	.90
.02	.75	.025	.85	.0005	.90
.0005	.45	.01	.80	.0004	.85
.00015	.35	.006	.60	.00025	.85
.00005	.35	.004	.60	.00015	.85
1000 V.					
.01	.75	.0004	.75	.00005	.75
.0005	.50	.0007	.75	3000 V.	
1500 V.					
.005					

SIGNAL LIGHTS

Type K3, 12 Volt. Signal Lamps. Portable bakelite enclosed 12 Volt Sealed Beam Light. Use as Flashing Signal or Steady Spot. Comes with mounting bracket for permanent mount with carrying case, and 20 feet rubber covered Heavy Duty Extension Cord. All New..... \$6.95 Ea.

CAPACITORS • FIXED • OIL FILLED

Solar, Pyralon, C.D., Etc.		AL D.C. VOLTAGE RATINGS	
2	MFD. 40C V. \$0.79	1	MFD. 1000 V. \$1.00
3X3	MFD. 400 V. 1.95	2	MFD. 1000 V. 1.25
10	MFD. 60 V. 2.95	5	MFD. 1000 V. 3.95
1	MFD. 600 V. .75	8	MFD. 1000 V. 3.95
4	MFD. 600 V. 1.95	10	MFD. 1000 V. 4.95
3	MFD. 600 V. 1.95	2	MFD. 2000 V. 1.50
6	MFD. 600 V. 1.95	4	MFD. 1500 V. 2.25
7	MFD. 600 V. 1.95	1	MFD. 2000 V. 1.95
8	MFD. 600 V. 1.95	2	MFD. 2000 V. 1.95
8X8	MFD. 600 V. 2.25	3	MFD. 3000 V. 3.50
10	MFD. 600 V. 2.25	1	MFD. 3000 V. 3.95
15	MFD. 600 V. 2.25	1	MFD. 5000 V. 5.95
20	MFD. 600 V. 2.95		

All Mail Orders Promptly Filled. F.O.B. San Francisco. All California Orders—Add 3% Sales Tax. Do not send postage stamps. 20% Dep. on all C.O.D. orders. All items subject to prior sale and prices subject to change without notice. On purchases under \$5.00 send full amount.

STANDARD SURPLUS 1230 Market St., San Francisco 3, Cal. Telephone HEMlock 1-3106

**INTERNATIONAL
RECTIFIER
CORPORATION**

EL SEGUNDO
CALIFORNIA

**RADIO TV
TYPE
SELENIUM
RECTIFIERS**



**NOW
AVAILABLE
AT
YOUR
FAVORITE
JOBBER**

**Widest Range
in the Industry**

Ask for Bulletin JRP-2

**INTERNATIONAL RECTIFIER
CORPORATION**

1521 E. Grand Ave., El Segundo, Calif. - Phone: ORegon 8-6281
CHICAGO: 205 W. Wacker Drive - Phone: Franklin 2-3889
NEW YORK: 591 Madison Avenue - Phone: Plaza 5-8665

Installing Color Tubes

(Continued from page 48)

convergence voltage shape control can be adjusted.

9. The vertical dynamic convergence adjustments affect the horizontal and d.c. convergence settings and *vice versa*. Again it will be necessary to spend some time and care in making all adjustments and subsequent touch ups. The author had to start all over twice during his first convergence adjustment problem, but after some practice the convergence procedure now takes only about 10 minutes.

10. As a final check, vary the d.c. convergence control slightly and see if it improves convergence at the edges. If it does, some improvement in the dynamic convergence setting is needed. When d.c. adjustments show no such improvement, the dynamic convergence controls are properly set.

In the large screen, 19-inch shadow-mask picture tubes, the convergence adjustment is somewhat different since magnetic rather than electrostatic convergence is used. Between the purity coil and deflection yoke a set of three electromagnetic assemblies are located as shown in Fig. 3. In place of the three positioning magnets a single permanent magnet assembly is used which has major control over the blue electron gun. To adjust convergence in this system it is again helpful to use a dot pattern. Proceed as in the case of the 15-inch tubes up to the d.c. convergence adjustment, then follow the steps given below.

1. Set all dynamic convergence controls to minimum and adjust the red and green d.c. convergence potentiometers to give yellow dots in the center of the screen.
2. Adjust the blue d.c. convergence control and positioning magnet to obtain white dots in the center.
3. Adjust vertical and horizontal dynamic convergence controls for equal color triangles along the vertical and horizontal axes.
4. Readjust the three d.c. convergence controls for uniform white dots. Slight touch ups of the dynamic convergence controls may be required. Because the convergence forces are magnetic, the a.c. through the convergence coils will look like the voltage wave-

Fig. 9. Dot pattern when the d.c. convergence voltage is too high. Here, the blue dot is on top with the red to the left and the green to the right below.



form in Fig. 6. The voltage across the coils will look somewhat like a sawtooth. Another feature of the 19-inch tube convergence adjustment is the reduced interdependence between the different controls. This makes for simpler and faster convergence adjustment.

Before looking at color pictures, the brightness and screen controls must be set properly. First, with no picture on the screen, turn the brightness control to maximum and adjust the red, green, and blue screen controls (see Fig. 5) to obtain a medium gray screen appearance. This should be approximately the brightness of an almost dark monochrome raster such as appears when no signal is received on a monochrome receiver. Balance out the three colors until a neutral gray shade is achieved. Now tune in a monochrome picture and set the contrast control for good white highlights. Adjust the blue and green background controls until the white is a true white and contains no dominant color. Next, turn the brightness control down until the white highlight is medium gray and touch up the green and blue background controls until this is again a neutral shade. The correct adjustment of these controls is achieved when the brightness control variation does not produce a change in hue, but only in brightness.

Color Adjustment

The great moment has arrived and we are ready for the first color pictures. In Fig. 5, separate red, green, and blue gain controls are indicated. Many manufacturers do not advise touch ups of these controls without special test signals or test equipment. Usually these controls are set carefully at the factory and do not need further adjustment.

Tune in a color telecast just like any other TV signal. Adjust the chromaticity control slowly until the colors appear vivid enough. Too little chromaticity will result in pastel shades or pale colors instead of rich saturated colors, while too much chromaticity will result in dark flesh tones. If it appears as if a red, green, and blue rainbow moves over the picture, the color sync section is out of synchronization. If flesh tones appear purple and red appears blue, the color sync phase is wrong. These adjustments are usually on the chassis or under a panel together with other secondary controls.

If it appears that the various colors are wrong, that red is too purple, yellow too orange, etc., this should never be compensated for with the screen, background, or brightness controls. Such a defect is best adjusted with a color test signal of known colors, such as can be obtained from a color bar generator or else from a station test pattern. Then the red, green, and blue gains can be set, the *I* and *Q* channels adjusted, and the entire matrixing unit can be serviced.

The customer should be carefully instructed in the use of the operating controls and warned against adjusting the secondary controls under the hinged front panel of the set and on the side or back of the chassis. —30—

International Short-Wave

(Continued from page 64)

(Ferguson, N. C.) Noted parallel over 4.950 to after 2215. (Miller, Ga.)

British New Guinea—VLT6, 6.130, Port Moresby, fair around 0330 with news, weather reports. (Kapp, Calif.)

Bulgaria—Sofia, 7.671, noted for a few days parallel over new 7.215 channel, but has returned to 7.255 where has news 1500-1515, 1615-1645; also says has news 1715-1730. (Pearce, England) Excellent 2000-2030 to North America on 9.700. (Rubin, Mich.) And 1730-1800 on same channel.

Cape Verde Islands—CR4AA, 7.398A, noted opening 1500 with band selections, closing 1700A with "A Portuguesa." (Pearce, England)

Ceylon—Radio Ceylon, 9.52, noted closing 1228. (Pearce, England) Is fair level on this channel some days from 2030 opening, but usually has QRM from Copenhagen, same frequency. (Saylor, Va.) Is now on 11.770 at 2030-2330. (Sanderson, Australia)

Chile—CE766, 7.66 Santiago, tuned 0045 when had music and comedy program in Spanish. (NNRC) CE1180, 11.998A, noted some days 1800-2100, fair volume in Minn. (Rowell)

China—Radio Peking, 11.65A, has news again 0930, also 0400; not audible every day; 11.96, 15.06A are used for English 2200-2228A sign-off. (Balbi, Calif.)

Colombia—HJFW, 5.020, noted 2215-2300, all-Spanish. (Reidler, Pa.) HJEF, Cali, noted on 4.76A to 2330 close-down. (Powers, O.) HJFU, 4.797A, Armenia, caught signing off 2310.

Cuba—COCQ, measured 9.670, Havana, noted 0755 with identification in Spanish, then religious service in that language. (Ferguson, N. C.)

Cyprus—ZJM6, 6.790, Limassol, Sharq-al-Adna, noted with news in Arabic 2300-2315 fade-out. (Morris, O.) The 11.72A outlet heard 2345 with news in Arabic, then music. (Sanderson, Australia)

Denmark—OZF3, 6.060, Copenhagen, noted 1510 relaying Home Service in Danish; 1600 news in Danish, off 1617 after call. (Pearce, England) Heard some days on 15.165 at 0900-1000, English 0950. (Butcher, Mass.)

FREE!

ANY ONE OF THESE
HI-FIDELITY RECORDINGS

{50 to 15,000 Cycles}

BEETHOVEN

"Egmont" and "Coriolanus" Overtures

OR BIZET OR BACH "Brandenburg"

"Carmen" Suite

Long
Playing

33 1/3
R. P. M.
Long
Play

HERE is an amazing offer to lovers of fine music! Yours FREE—any one of these magnificent recordings—brilliantly performed by the celebrated Netherlands Philharmonic Orchestra, under the baton of the distinguished British conductor Walter Goehr. These recordings, pressed from the purest "Vinylite" Plastic, represent the last word in HIGH FIDELITY reproduction. Each has remarkable beauty of tone and virtual absence of surface noise. Yet you may have any one of them FREE! OR—you may have ALL THREE records for ONLY \$1.

We make this amazing offer to introduce you to the superb new Musical Masterpiece Society recordings. Each month you will receive notice of the two recordings selected by the Society. You may accept these records at our special price of LESS THAN ONE THIRD the usual retail price. Or you may reject any monthly selection either before or after you receive it.

There are no "strings" attached to this generous offer, and you are not obliged to buy any records

at all! So rush coupon to: The Musical Masterpiece Society, Inc., Dept. 477, 250 W. 57th St., New York 19, N. Y.

The Musical Masterpiece Society, Inc.
Dept. 477, 250 W. 57th St.
New York 19, N. Y.

Please send me the high-fidelity L. P. records checked:

BEETHOVEN BIZET BACH

NOTE: If you have checked ONE record, it is FREE—simply enclose 25¢ to help cover cost of special packing and shipping. If you have checked ALL THREE, enclose \$1. (We pay postage.)

Please notify me each month of the Society's monthly selection of records which I may accept or reject. I am not obligated to purchase any records. And I may return any I do buy if not completely satisfied.

Name

Address

City..... Zone... State.....

Save More Dough

at **Harjo**

701A TRANSMITTING TUBE, \$4.95

Duplicates many of features of 4-250. A pair will surprise you!

DUMONT 3CP1 CATHODE RAY TUBES \$1.79; 3 for \$5

Same as used in Dumont 224A Oscilloscope. New.

POWER TRANSFORMER, 110V. 60 cv. primary. 150V. 30MA secondary. 6.3-1 amp. Fil. FB for grip dip kits, test equip., etc.—79¢ plus 35¢ for postage and shipping.

CERAMIC CONDENSERS

Kit of 100 asstd. Brand new, standard brands. \$10 value.

\$ Post-paid

GET INTO ONE OF THESE
GREATER OPPORTUNITY FIELDS

Electricity or
Radio-
Television

TRAIN IN THE GREAT SHOPS OF
COYNE OLDEST, BEST EQUIPPED
SCHOOL OF ITS KIND IN U. S.

Prepare for your future NOW. Get practical training in TELEVISION—RADIO—ELECTRICITY—ELECTRONICS—all vital in Industry. Prepare now for a better job that also offers a real future in the years ahead. Learn on real equipment at Coyne—no advanced education or previous experience needed.

Build Your Own Interior - Styled Cabinets

KITS

by **Cabinart**

presenting the

paul klipsch-designed REBEL IV . . .



Now you can build your own Klipsch Corner Horn Enclosure and save money — identical in acoustic design to assembled units and easily put together with a minimum of tools. Priced for the home-builder in unfinished birch.

\$36.00* Net for 12" model

\$42.00* Net for 15" model

BASS REFLEX and EQUIPMENT CABINETS

Ideal housing for hi-fi components — removable panels make future changes easier. Loudspeaker cabinet acoustically designed for either 12" or 15" speaker.

Overall dimensions:
33 1/2", 23",
16" Tuner
Compartment:
20" H., 21 3/4"
W. (inside dimensions),
15 1/4" Deep.
Baffle volume:
6 cubic feet.

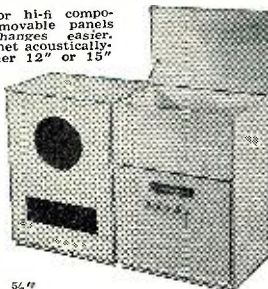

All kits include 5/8" white pine plywood cut to size baffle pre-cut for 12" or 15" speaker, Saran Plastic Acoustic Cloth, Kim-sul Acoustic Insulation, Assembly and finishing instructions, hardware, plastic wood, sandpaper and glue.

No. 80 . . . \$27.00*
(Equipment Kit)

No. 8112 \$18.00*
(12" speaker)

No. 8115 \$18.00*
(15" speaker)

CORNER FOLDED

3,975 in *English* for Europe 1315. (Pearce, England)

Ethiopia—Radio Addis Ababa, ETAA, 15.054AV, still has *English* news 1315 on Sat. *only*; other days has music at that time. (Pearce, England, others)

France—Paris recently has been noted opening 1000 on 7.055A with same program as in progress on 6.200; heard with *English* Service 1500-1600 on 6.045, 9.620A. (Pearce, England) More recently, I've noted this at good level over 11.700A. (Boord) Parallel on 9.625A. (Bellington, N. Y.)

Heard opening 0030 on 9.55; *English* talk 0045; QRM'd 0100-0130 sign-off. (Balbi, Calif.)

French Equatorial Africa—Lately, Brazzaville has been using 9.625A instead of 9.440 for portions of its broadcasts; if not found on 9.440, try 9.625A. (Pearce, England, others) *Radio A.E.F.*, Brazzaville, noted on 9.965 at 1400 with news in French, 1415 with songs. (Pearce)

French Guiana—Radio Cayenne, 6.233A, noted 1735 with popular musicals, wiped out 1800 by QRM. (Pearce, England) Heard opening 1730 in French, bad CWQRM. (Scheiner, N. J.)

French West Africa—Dakar's 9.562 channel still noted with *English* 1715-1730 closedown Mon., Wed., Fri., Sat.; Portuguese then Tue., Thur. (Murphy, N. Y.; Butcher, Mass., others)

Germany—RIAS, 6.005A, Berlin, noted at fair level 2030-2300 when QRM took over; news in German 2100, 2200. (Saylor, Va.) *Summer* schedules of Overseas Service, Cologne, are 0530-0830, 11.795, 15.275; 0930-1230, 1300-1600, 1700-2000, 11.795, 7.290; 2030-2330 (to North America), 6.075, 7.290.

Gold Coast—ZOY, 4.915, Accra, noted in Britain with news 1215, closing 1300. (ISWL)

Greece—FBS, 7.420, Athens, strong with music 1010 tune-in, had QRM from Moscow; songs at tune-in 0115. (Pearce, England) *Radio Athens*, 9.607, heard with news 1245, fair level in N. Y. (Chatfield) VOA's "Truthship," *The Courier*, noted on 6.015 at 1945-2045 sign-off. (Butcher, Mass.)

Guadeloupe—FG8HA, 6.066A, Basse-Terre, heard through terrific QRM 1800-1900. (Butcher, Mass.)

is
then
ces

POWER TRANSFORMERS

Comb. Transformers 115V/50-60 cps. Input				
CT-479	7000V/.018A (2 X Ind. V. Test) 2.5V			
	5A/17,800 V. Test			\$37.50
CT-138	520-0-520V/500MA 6.3V/3A, 6.3V/17A, 2 X 5V/3A			14.75
CT-013	450-0-450V @ 200 MA, 10V/1.5A, 2.5V/3.5A 5V/3A			6.95
CT-341	1050 10MA.—625V @ SMA, 26V @ 4.5A 2x2.5V/3A, 6.3V @ 3A			9.95
CT-071	110V .200A 33/200, 5V/10, 2.5/10			4.95
CT-403	350VCT .026 A 5V/3A 6.3V/2A, 1.5V/3A			2.75
CT-331	585VCT .086 A 5V/3A 6.3V/6A, 1.5V/3A			4.25
CT-442	525VCT 75 MA 5V/2A, 1 CT/2A, 50V/200 MA			3.85
CT7-501	650VCT/200MA 6.3V/8A, 6.3V/5A			6.49
CT-444	230-0-230V/.085A, 5V/3A, 6V/2.5A			3.49

MOBILES! C.D. MEN! CAP!!

PE-101 DYNAMOTOR—Converts Easily to Supply Unit Delivering 12 VOLT INPUT OR 6 V INPUT 610 V @ 150 MA OR 300 V @ 90 MA 325 V @ 125 MA 160 V @ 110 MA
BRAND NEW WITH CONVERSION DATA \$3.75

Send check or M.O. Shipping charges C.O.D.

DYNAMOTORS

TYPE	INPUT VOLTS	AMPS	VOLTS	OUTPUT AMPS	PRICE
DD 416	14	6.2	330	.170	\$6.75
DM 338	28	3.1	330	.170	3.95
BD AR 93	28	3.25	375	.150	7.50
23350	27	1.75	285	.075	3.95
B-19 Pack	12	5.4	250	.110	8.95
			500	.050	
DA-3A*	28	10	300	.060	6.95
			150	.210	
			14.5	5.	
PE 73 CM	28	19	1000	.350	22.50
DD 63E	14	2.8	220	.120	12.95
D-402†	13.5	12.2	300	.200	
			8.8VAC	.06	12.50
SP 175	18	3.2	40	.06	4.49
DM 25†	12	2.3	250	.05	6.95

† Less Filter
 † Used. Excellent

* Replacement for PE 94.

INVERTERS

PE-218-H: Input: 25-28 vdc, 92 amp. Output: 115v. 350/500 cy 1500 volt-amperes. NEW \$37.50
 PE-206: Input: 28 vdc, 36 amps. Output: 80 v 800 cy, 500 volt-amps. Dim: 13"x5 1/2"x10 1/2".
 New \$22.50

Send M.O. or Check, Shipping Chgs. C.O.D.

COMMUNICATIONS EQUIPMENT CO.

131 Liberty St. Dept. N-7 New York City 7, N. Y.

PUT YOUR OSCILLOSCOPE TO WORK!



Dust off that oscilloscope of yours! Put it to work fully on the dozens of jobs it can do better than any other instrument. Handle jobs TWICE AS FAST, better and lots more profitably!

This big book, MODERN OSCILLOSCOPES AND THEIR USES shows you how . . . in a way you can really understand. Clearly and simply, it explains exactly where and how to use your 'scope on all types of AM, FM and TV service . . . from trouble-shooting to set re-aligning and everything in between. No fancy theory.

2130-2210 to North America, Australia, New Zealand, 9.59, 6.025.

Hong-Kong—ZBW3, 9.525, still has BBC news relay 0600. (Sanderson, Australia)

Hungary—Budapest's 6.248A channel noted 1720-2230, part of time relays Moscow's North American Service (*English*); has CWQRM. (Reidler Pa.) Noted with *English* 1500-1530 on 6.248A, 7.220; says also has *English* 1700-1730 on these channels. (Pearce, England)

India—Mysore is currently scheduled 2030-2145, 4.800, 0300-0400, 6.065, 0700-1200, 4.800. Srinagar is scheduled 2130-2330, 4.860, 0200-0330, 6.110, 0730-1145, 3.277. (Scheiner, N. J.)

Indo-China—Radio *Hirondelle*, "La Voix d'Union Forces Francaise de Indo-Chine du Nord," 7.408, Hanoi, tuned 1035 when had dance music records; call in French 1051, then news headlines in French; closed 1100A with "La Marseillaise"; also noted from around 1730 and with news in French 1800. *Radio France-Asie*, Saigon, heard still on 11.83 with *English*-French session 0900-1100. (Pearce, England) Noted over 15.420 at 0500 with news, then good musical session.

Iran—Radio *Teheran* is back on 15.100 for *summer*, noted with call in Arabic 1330, news in German 1445. (Pearce, England) Heard with French 1500 over 15.100 parallel 3.785, 6.155. ("La Radio Mondiale," France) Should have *English* 1515 and close 1530A.

Iraq—Radio *Baghdad*, 11.700A, noted 1330 with vocal Arabic music, 1400 news in Arabic, 1415 call in *English*, but QRM was bad then and was jammed; should have *English* session 1415-1500 closedown. (Pearce, England) Heard with news in Arabic 2345, then Western music. (Sanderson, Australia)

Israel—When this was compiled, Tel Aviv, 9.010A, still had *English* ("Voice of Zion") session 1615-1700 closedown, but by now may be on *summer* time, in which case this may be *one hour earlier* (1515-1600). (Pearce, England, others) Heard well 1655. (Leake)

Italy—Rome's 11.905A outlet noted with news 1615, news in French 1630. (Bulmur, Brt. Columbia) The *Sun*. 1240-1250 period on radio subjects noted strong on 11.810, 7.290, said also on 15.400. (Pearce, England) Heard with Spanish session 2130-2150 on 6.213A. (Stark, Texas)

Japan—AFRS, 6.08, Far East Network, Tokyo, has replaced 11.815 outlet, fair signal 0400; JKL, 4.86, is parallel. (Balbi, Calif.) *Radio Japan* has been sending out monitoring report blanks to selected listeners. (Anlado, Miss.) Often *tests* over JOA3, 9.695, JOB4, 11.780, at 2300-2400 with Japanese vocal recordings, usually has no announcements, makes adjustments, stations go on-and-off, usually only parts of recordings are played; opens 2400 to North America. (Morgan, Calif.)

Kenya Colony—Nairobi, 4.855, noted 1430 with orchestral recordings. (Pearce, England)

July, 1954

NEW ITEMS

★ RECORDER FOR CODE TAPES

BC-791—Recorder and Amplifier of Code Signals directly from a Radio Receiver or local sending on 3/4" Paper Tape with ink writing stylus. Tape can be played back on any TG-10 or TG-34 Keyer. Uses 1/117N7GT and 2/117P7GT Tubes. 115 Volt 60 cycle operation. No Tubes, Tape, or Tape Puller included. Tape Puller from TG-10 or TG-34 can be used.

PRICES—NEW: \$7.95 — USED: \$4.95

★ PRACTICE CODE TAPES—

Code Training and Practice Inked Paper Tapes on 16 MM 400 ft. Reels for telegraph and radio operation. 15 Reels to a Set, in wood case—for use with TG-34A and TG-10 Keyers.

Complete SET—Price..... \$12.95

SEPARATE TAPES for following lessons:

Tape #11—Traffic Tape #8—Code Groups
Tape #12—Traffic Tape #2—Receiving

Each on 16 MM Reel, in metal container: \$1.25 Ea.

TG-34A KEYS: 115 or 230 V. @ 50 to 60 cycle—KEYER TG-34A is an automatic unit for reproducing audible code practice signals previously recorded in ink on paper tape. By use of the self contained speaker, the unit will provide code practice signals to one or more persons or provide a keying oscillator for use with a hand key. The unit is compact, in portable carrying case, complete with tubes, photo cell, and operating manual. Size: 10 9/16" x 10 1/2" x 15 13/16". Shipping weight: 45 lbs. Prices—While They Last:

BRAND NEW: \$24.95 • USED: \$14.95

TG-10 KEYS: Same function as TG-34A, only larger, using 2/6N7—2/6L6—2/6S17—1/5U4G Tubes and 1/923 Photo Cell. Housed in standard Metal Cabinet, can be removed for 19" rack mtg. Size: 11" H x 24" W x 18 1/2" D.

PRICES—NEW: \$29.95 — USED: \$19.95

BLOWERS—115 VAC 60 CYCLE



SINGLE TYPE: (Illustrated at left) 100 CFM. 2 1/4" intake; 2" outlet. Complete size: 5" x 6". Order No. 1C939.....\$8.95

DUAL TYPE: 100 CFM. 4" intake; 2" Dis. Each Side. Complete Size: 8" x 6". Order No. 1C880.....\$13.95

COMPACT TYPE: 108 CFM. Motor built inside squirrel cage, 4 1/2" intake; 3 3/4" Dis.

Complete size: 4 1/4" W x 8 3/8" H x 8 3/8" D. Order No. 2C067.....\$11.50

FLANGE TYPE: 140 CFM. 3 1/2" intake; 2 1/2" Dis. Complete size: 7 1/2" W x 7 1/4" H x 6 3/4" D. Order No. 1C807.....\$13.95

FLANGE TWIN: 275 CFM. 4 1/2" intake; 3 1/4" x 3" Dis. Complete size: 11 3/4" W x 8 3/8" H x 8 1/16" D. Order No. 2C069.....\$21.95

TRANSFORMERS—110 V. 60 CYCLE PRI.:

5 Volt CT-25A—10,000 V. Ins. OPEN FRAME—6" x 5" x 4 1/2".....\$7.95
6.3 V. 1 Amp.....1.25 24 V. 1 Amp.....1.95
24 V. 1/2 Amp.....1.50 6, 24, or 30 V. 8 A. 9.95
Sec. Two 12 V. 4 A. Winding—Gives 12 V. 8 A. or 24 V. 4 Amp.....5.95

CONSTANT VOLTAGE TRANSFORMER—115 V. 60 Cycle 80 VA. Sola # 30726.....\$14.95

SOUND POWERED HEAD AND CHEST SET

Navy Type—No Batteries Required—Ideal for TV Antenna Installations and many other uses. 20 Ft. Cord. Used Tested:.....\$5.95 EA.



TELEPHONE WIRE FOR THE ABOVE

COMBAT TYPE—2 Cond. Twisted, Rubber Covered. Medium Weight, W-130.....@ 1c per Ft.
FIELD WIRE—2 Cond. Twisted, Weather-proof, Heavy Duty. W-110—525 Ft. Roll.....\$4.75

Address Dept. RN • Minimum Order \$5.00 • Prices F.O.B., Lima, O. • 25% Deposit on C.O.D. Orders

FAIR RADIO SALES 132 SOUTH MAIN ST. LIMA, OHIO

Something NEW in Electronics to be Announced in August Issue



Free!

Get More Service Calls with **EICO DECALS**

For Store Windows & Cars.

Write EICO

Brooklyn 11, N.Y. Dept. RD-7

ANTENNA EQUIPMENT



MAST BASES—INSULATED:

MP-22 BASE—(Illustrated) Ins. spring action; direction of bracket can be raised or lowered easily. \$2.95

MP-132 BASE—1" heavy coil spring; 2" Ins. Overall length: 1 1/2". Weight: 2 3/4 lbs. \$5.95

MP-S-33 BASE—Insulated type with heavy coil spring and 5" dia. Ins. Requires 2" hole for mounting. Weight: 9 lbs. \$5.95

MP-48 BASE—Insulated type base with heavy coil spring. Requires 1 3/4" mounting hole. Weight: 11 lbs. \$6.95

MP-37 BASE—Insulated type with heavy coil spring. 7" dia. insulator; requires 1 3/4" hole for mounting. Weight: approx. 10 lbs. \$8.95

MAST SECTIONS FOR ABOVE BASES:

Tubular steel, copper coated, painted in 3 ft. sections, screw-in type. MS-53 can be used to make any length with MS-52-51-50-49 for taper. Any section.....@ 50¢ Each
Larger Diameter Section: MS-54.....75¢

ARC-5 COMMAND EQUIPMENT:

R-25/ARC-5 Rec. 1.5 to 3 MC. No Tubes. Used: \$14.95

R-26/ARC-5 Rec. 3 to 6 MC. No Tubes. Used: 7.95

R-27/ARC-5 Rec. 6 to 9 MC. No Tubes. Used: 6.95

R-28/ARC-5 Rec. 100 to 156 MC. No Tubes. Used: 12.95

T-20/ARC-5 Trans. 4 to 5.3 MC.....New: 16.95

T-22/ARC-5 Trans. 7 to 9 MC.....Used: 14.95

274-N COMMAND EQUIPMENT:

BC-454 Rec. 3 to 6 MC.....Used: \$ 9.95

BC-455 Rec. 6 to 9 MC.....Used: 9.95

BC-458 Trans. 5.3 to 7 MC.....Used: 9.95

BC-459 Trans. 7 to 9 MC.....Used: 10.95

FT-225 Mtg. F/BC-156.....Used: 50c.....New: .95

FT-220 3 Rec. Shock.....Used: \$1.50.....New: 2.50

FT-221 3 Rec. Shock.....Used: .50c.....New: .95

BC-450 3 Rec. Cont. Box.....Used: \$1.50.....New: 2.50

BC-451 Trans. Cont. Box.....Used: \$1.00.....New: 1.75

PLUG—Male for rear of Rec. or Trans......75

DM-32 Dynamtr F/Rec. 24V. Used: \$2.95.....New: 6.95

DM-33 Dynamtr F/Modulator & Trans.....Used: 2.95

Coaxial Cable & Connectors



CD-1071 CORD—With PL-259 Plugs each end. Removable Vinylite covering over Plugs, 50 ohm coax 2 Ft. long. Prices: 59¢ Each—Or in Lots of 10 @ 50¢ Each.

PL-259—Plug ea. end & 32"—RG-54/U—58 ohm.....50¢

UG-21/U—Plug ea. end & 32"—RG-11/U—75 ohm.....50¢

UG-22/U—With 4" Coaxial Cable.....50¢

RG-8/U (SPECIAL) 51.5 ohm. Same size as RG-8/U.

Prices: 1 to 100 ft @ \$2 per ft.—100 to 500 ft. @ 7 1/2¢ per ft.—500 to 1000 ft @ 7¢ per ft.—1000 ft. @ 6 1/2¢ per ft.

RG-34/U—71 ohm, 145 ft. length.....\$15.00

DYNAMOTORS

PE-101 DYNAMOTOR—6 or 12 Volt. (Reprints of original CO conversion articles—Oct. & Dec. '52 issues—furnished.) This is the Dynamotor the Hams have been talking about! Easily adapted to supply 625 V. @ 150 MA. and 325 V. 125 MA. @ 12 Volts— or 300 V. 90 MA. and 160 V. 110 MA. @ 6 Volts.....NEW: \$4.95

INPUT VOLTS:	OUTPUT VOLTS:	MA.	STOCK No.	PRICES USED:	NEW:
14 VDC	230	90	DM-21	\$9.95	
14	330	150	BD-87	6.95	\$8.95
14	250	50	DM-25	6.95	8.95
14	1000	350	BD-77	14.95	29.95
28	210	125	DY-22	7.95	
12 or 24	500	50	USA/0515		4.95
12 or 24	275	110	USA/0516		4.95
5 or 12	500	160	PE-103	29.95	39.95
12	230	90	PE-133	6.95	8.95

LEARN TV SERVICING

Send for free 24-page illustrated booklet which tells you how to become a successful TV technician. America's leading TV servicing school offers you a specialized training program that omits non-essential math & design theory. You concentrate on radio & TV servicing only. You get professional training & experience right in our fully-equipped shops & laboratories. Write Dept. R-74.

Approved for Veterans

WESTERN TELEVISION INSTITUTE
341 W. 18th St. Los Angeles 15, Calif.

Examine FREE



Prentice-Hall ELECTRONICS & UHF LIBRARY

Edited by W. L. EVERITT

5 VOLUMES 1662 ILLUSTRATIONS

Pay Easy Installments If You Keep Set

Turn to this new, up-to-date Library with complete confidence, for dependable facts on any phase of modern electronic theory and practice. These volumes, by outstanding authorities, give you thorough guidance—clearly written, logically arranged, profusely illustrated.

Electronic Fundamentals and Applications

By Prof. John D. Ryder, Univ. of Illinois

Complete, logical, easy-to-follow treatment of (a) physical principles underlying electron tubes, (b) characteristics of vacuum tubes, (c) all basic tube circuits. Includes: Electron Ballistics. Cathode-Ray Tubes. Emission of Electrons. Space Charge in Vacuum Tubes. Diode Rectifiers. Triodes. Multi-Element Tubes. Small-Signal Amplifier Circuits. Audio-Frequency Amplifiers. Radio-Frequency Amplifiers. Oscillator Circuits. Modulation Systems. Wave-Shaping Circuits. Gaseous Conduction. Gas Diodes. Gas Control Tubes and Circuits. Photoelectric Cells. Solid-State Electronics.

Electromagnetic Waves and Radiating Systems

By Prof. Edward C. Jordan, Univ. of Illinois

Covers entire field of electromagnetic engineering. Includes propagation as well as radiation and transmission. Full treatment of UHF transmission lines, wave guides, antennas, slot antennas, radiation and diffraction, ground-wave and sky-wave propagation.

Ultra High Frequency Engineering

By Thomas L. Martin, Univ. of Arizona

Theory and technique of ALL the new fields of electronic engineering: Radar, Telemetry, Electronic computing, Facsimile, Television, Blind landing systems, Pulse-time modulation, Ionosphere measurements . . . and the others.

Networks, Lines and Fields

By Prof. John D. Ryder, Univ. of Illinois

Network transformations and theorems. Resonance. Impedance transformation and coupled circuits. Filters. General transmission line. High-Frequency line. Equations of the electromagnetic field. Radiation. Transmission and reflection of plane waves at boundaries. Guided waves between parallel planes. Wave guides.

Elements of Television Systems

By George E. Anner, Univ. of Illinois

Complete basic theory, plus current practice, covering: Closed TV Systems. Commercial Telecasting Systems. Color TV Systems. Gives clear exposition of all phases of picture transmission, including the new technique of dot interlace.

SEND NO MONEY—EXAMINE FREE

Just mail coupon below to get complete 5-Volume Set on 10 DAYS' FREE TRIAL. If not completely satisfactory, return in ten days and owe nothing. Or keep the set and pay only \$5.35 down and \$8 a month for five months until full price of \$45.35 is paid. Decide for yourself—without risk or obligation—just mail coupon to examine Library ten days free.

PRENTICE-HALL, Inc., Dept. M-RTN-754
Englewood Cliffs, New Jersey

Send me the Prentice-Hall ELECTRONICS & UHF LIBRARY (5 Volumes) for ten days' free examination. If fully satisfied in ten days I will send you \$5.35 plus few cents postage and then \$8 a month for five months until full price of \$45.35 is paid. Or I will return the Library in ten days and owe nothing.

Name

Address

City and State

Malaya—BFEB, 15.435, Singapore, strong 1115-1145 relaying BBC; before closing 1150, gave schedule for India 0800-0900, 15.435, 0915-1030, 11.820, 1030-1130, 15.435, 11.820; for Burma 0800-0815, 11.955, 7.120, 0815-0900, 7.120, 0915-1130, 9.690, 7.120; had "Radio Newsreel" from BBC 0900, then program in Burmese on 11.955. (Pearce, England) Heard on 11.820 at strong level 0715-0900 sign-off in *English*, relaying BBC, announced 15.435 in parallel; also announced new channel of 7.955 with different program in *English* 0800. (Miller, Ga.)

Radio Malaya, 7.200, Singapore, noted 0630 with news. (Sanderson, Australia) Kuala Lumpur, 6.025, heard 0915 with talk in *English*. *Forces Broadcasting Service*, 5.010, noted with native music, woman announcer, bad QRM, 0830. (Morgan, Calif.)

Monaco—Radio Monte Carlo, 7.349, noted in *English* 1735-1800A close-down some days. (Stanley, Conn.)

Mozambique—Radio Clube de Mocambique, Lourenco Marques, has negotiations under way for the purchase of another 10 kw. short-wave transmitter and a 50 kw. medium-wave transmitter. (Scheiner, N. J.)

Nepal—Scheiner, N. J., has received word from officials of *Radio Nepal*, Kathmandu, that the station has never tested on 9.856 as reported by overseas sources; the new m.w. 250-watt transmitter likely will be used by August, but the new 5-kw. s.w. outlet will probably not come into use before next year. Is scheduled on 7.100, 250 watts, 2200-2350, 0250-0420, 0630-0720 with programs in Nepali, Newari, Hindi, *English* (latter 2340-2345, 0650-0655).

New Zealand—Summer schedules direct from *Radio New Zealand* read to Australia 1300-1545, ZL18, 9.52;

1600-2345, ZL19, 11.83; 0000-close, ZL18, 9.52. To Pacific Islands, 1330-1545, ZL2, 9.54; 1600-2345, ZL3, 11.78, 0000-close, ZL2, 9.54; closedown currently is 0545 weekdays, 0620 Sat., 0500 Sun.

Nigeria—Radio Nigeria, 4.800, Lagos, noted 1515 with African vocal music; 1430 had short story in African dialect. (Pearce, England) A Nigerian outlet is noted on 4.890A with *English* program of music 1500-1715. (Peddle, Newfoundland)

Norway—Oslo's 15.175 outlet heard at good level Sun. 1100 with religious program, at 1200 with "Norway This Week" (*English*). (Jones, N.C., others)

Outer Mongolia—Ulan-Bator-Choto, 6.250A, noted 0953 with man in Eastern language; 1000 gave call, had slow news in Eastern language, probably Mongolian; off 1022 with anthem. (Pearce, England)

Pakistan—Radio Pakistan, 7.010, noted with news 1015-1030; at 0515-0530 on 17.770 with "Radio Reel" in *English*; with news 0730 on 17.71. (Pearce, England) Heard on 7.150A with news 0730; on 11.726 at 2115 with news. (Sanderson, Australia)

Paraguay—ZPA1, noted on 5.95A at 1830, fair level in Spanish. (Chatfield, N. Y.) Moved from 6.275. (Stark, Texas)

Peru—OAX4V, 5.89, Lima, noted in Spanish, fair level 2000. (Chatfield, N. Y.) Lima's 9.562A outlet heard 2350-2400 when closed at strong level. (Deuring, Alberta)

Philippines—DZH9, 11.855, Manila, noted with news 1300, then religious program in Indonesian to 1330, followed by Japanese; identified in *English* 1330, 1400. (Bulmur, Brt. Columbia) DZH7, 9.73, noted 0700, news 0715. (Waltz, Washington) DZH5, 9.690, Manila, is sometimes good level

NEW TV STATIONS ON THE AIR

(As of June 25, 1954)

The following new stations bring the lists published in previous issues up to date.

STATE	CITY	STATION	CHANNEL	FREQUENCY RANGE (IN MC.)	VIDEO WAVELENGTH (IN FT.)	VIDEO POWER* (IN KW.)
Colorado	Grand Junction	KFPJ-TV	5	76-82	12.74	1.45
Oklahoma	Ada	KTEN-TV	10	192-198	5.08	252
	Enid	KGEO-TV	5	76-82	12.74	190
Texas	Beaumont	KBMT-TV	31	572-578	1.72	18.6
Territories	San Juan, P.R.	WAPA-TV	4	66-72	14.61	56
	San Juan, P.R.	WKAQ-TV	2	54-60	17.8	100
Mexican Border	Juarez	XEJ-TV	5	76-82	12.74	.5

KITO-TV, channel 18, San Bernardino, California; WTAC-TV, channel 16, Flint, Michigan; KACY, channel 14, Festus-St. Louis, Missouri; XELD-TV, channel 7, Matamoros, Mexico; CMTV, channel 11, Havana, Cuba, have gone off the air. WKLO-TV, channel 21, Louisville, Kentucky; and WPPG-TV, channel 46, Atlantic City, New Jersey, have been temporarily suspended.

Station WAAB-TV was listed incorrectly in the May table; it should have been:

Massachusetts	Worcester	WAAB-TV	20	506-512	1.94	74
---------------	-----------	---------	----	---------	------	----

The frequency of the video carrier = 1.25 + channel lower freq. limit. Total number of TV stations now on the air in U.S.: 383 (131 of which are u.h.f.).

*From Station CP application.

in Japan around 0500; DZH2, 9.640, Manila, noted 0645-0730 in Spanish, then with *English* identification. (Japanese Short Wave Club)

Poland—Warsaw has *English* for North America 0600-0630, 9.570; 0715-0815, 11.740; 1715-1745, 1945-2015, 2315-2345, 0030-0100, 6.025. (ISWC, London) Good on 11.745 at 0715-0815. (Pearce, Ill.)

Portugal—CSB51, 12.875, noted with native music 1730. (NNRC) *Emissora Nacional*, Lisbon, uses 11.96A at 0945-1200; opens 1200 on 9.795; noted on 11.915A at 1000; (Pearce, England) Rowell, Minn., notes CSA27 now on 9.746A at 1900-2100 at good volume in Portuguese to North America.

Portuguese Guinea—CQM, 5.839, Bissau, heard 1645 with popular recordings, announcements in Portuguese. (NNRC)

Roumania—Bucharest noted with *English* 1430-1500, audible on 6.143A, 6.210, 9.252A, 9.570, 12.032 (latter QRM'd by Cairo's 12.030A channel). (Pearce, England) Has folk music 1100 on 9.570, announced in *English*, French, German. (ISWC, London) Heard with *English* 2200-2225A, news 2220, on 9.57 parallel 6.143A, nice level. (Saylor, Va.) And 2330 on 9.57. (Sanderson, Australia, others)

Sao Tome—CR5SB, 17.677, noted Sun. from 0700 to 0740 fade-out. Should close 0800. (Ferguson, N. C.)

Sarawak—Malmo DX-aren, Sweden, says, "Radio Sarawak will begin its radio service soon, but only with a weekly program produced by Sarawak Broadcasting in Iban for the Sarawak Rangers in Malaya; the program is recorded in Kuchen and flown to Singapore for reproduction over the *Forces Broadcasting Service* transmitter on 5.010; will be radiated on Friday evenings (Friday mornings EST)."

Saudi Arabia—Revised schedules of Djeddah are 2300-2355, 3.990, 6.100, 6.175, 7.120, 9.650; 0700-0730, 1045-1135, 1215-1315, 3.990, 11.640, 11.750, 11.850, 11.950, for Arabic; Urdu 0800-0840 on 11.950 only as is Indonesian 0900-0940. (Scheiner, N. J.)

South Korea—Pusan, 7.935, heard 0600 with man in Korean, fair strength but with QRM. (Morgan, Calif.; Sanderson, Australia)

Spain—Valladolid, 7.006, noted opening with marches 1402. *Radio Mediterraneo*, Valencia, near 6.995, noted 1350 with Spanish news and sports results, call 1400, good signal. (Pearce, England) After trying 9.585 for some time, *Radio Nacional de Espana*, Madrid, is back on measured 9.356 (announces 9.363) with *English* 1515, 1800, 2215A. (Ferguson, N. C.; Shundberg, Ill.; others)

Spanish Morocco—A short-wave transmitter of 1 kw. on 6.067 soon will relay m.w. programs of *Radio Dersa*, 904 kc., Teutan, 5 kw., with Spanish 0700-0900, 1100-1300, 1500-1900; Arabic 0900-1100, 1300-1500. (Scheiner, N. J.)

Sweden—Radio Sweden, 9.535, is strong in Utah 2200-2330 or later. (Woltjen) Heard opening in *English* for Eastern North America 0700 on

HARVEY Always Has It

IN STOCK... FOR IMMEDIATE DELIVERY

STEWART-WARNER PORTAFONE

Model 73 Citizens 2-Way Radio

A lightweight, self-contained radio receiver and transmitter. Has a transmitting and receiving range from several hundred yards to several miles, depending upon terrain. Any U. S. citizen over 18 years of age can easily secure a license for this approved equipment. No technical knowledge required.

Portafone weighs only 28 ounces and fits comfortably into the hand. Power can be obtained from several supplies. The Portafone Handy Battery Pack is for portable use. The Central Station Power Pack is for use where 115 volt AC is available. The Portafone Citizens Radio Power Pack is for use with automobile storage batteries.

Portafone Model 73, per pair, including antennas and carrying cases (less batteries or power pack) **\$199.50**
Add Fed. Excise Tax 7.00

Handy Battery Pack..... 6.45
Central Station Power Pack..... 34.65
Citizens Radio Power Pack (specify 6 or 12 volts)..... 31.00



HI-FI SPECIAL!

Brand New... In Factory-Sealed Cartons

WESTERN ELECTRIC 755-A



8-inch PM High Fidelity Speakers

Reproduces entire audible frequency range with wide angle high frequency distribution. This famous speaker is offered at a fraction of its original price.

WHILE THEY LAST..... **\$24.60**



R-J SPEAKER ENCLOSURE

Bookshelf Model S-8-U

An ideal enclosure for the 8-inch Western Electric 755-A. Small enough to be inconspicuously mounted on a bookcase shelf. Reproduces amazingly clean bass fundamentals. Dimensions: 11" high x 10" deep x 23 1/2" long.

Model S-8-U for 8" speakers..... **\$24.50**

SONAR SONAFONE

Portable and Marine Radiophone Model M4W

Compact, 4-channel, 2-way radio telephone. Has built-in antenna, speaker, and rechargeable batteries. Weights under 20 lbs. Transmitter range: 5 to 50 miles. Covers Coast Guard, telephone and two ship-to-ship channels.

Complete (less crystals)..... **\$198.50**

Fed. Tax 6.62 **\$198.50**
Battery Charger..... 19.95



TV SPECIAL! Famous RCA TUNERS

Brand New...

Complete with 3-6J6 tubes each **\$490**

Same as used in the RCA 630TS and BT530 television chassis. Has 21.25 mc sound, and 25.2 mc video outputs. Ideal for servicemen, experimenters, etc.

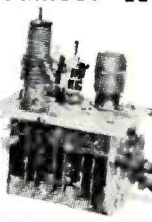

NATIONAL NC-98 RECEIVER

An outstanding, sensitive receiver of advanced circuitry. Covers from 550 kc to 40 mc. Special features include: Crystal Filter... 'S' Meter... Accessory Socket... Calibrated Electrical Bandspread on either Amateur or SWL Bands... 1 RF Stage... 2 IF Stages... Slide Rule Dials... Antenna Trimmer... Noise Limiter... Provision for Narrow Band Adapter... Separate HF oscillator. Complete with Tubes and built-in Power Supply (less speaker)..... **\$149.95**



Speaker in matching cabinet..... **\$11.00**

Anywhere in the world—order by mail direct from Harvey. Enclose estimated shipping charge.

Excess will be refunded.
NOTE: Prices Net, F.O.B., N.Y.C. Subject to change without notice.

Generous Trade-in Allowances On Your Present Equipment.

HARVEY RADIO COMPANY, INC.,

103 W. 43rd St., New York 36 · JU 2-1500

RECEIVING TUBES

THREE TOP BRANDS ONLY! AT TREMENDOUS SAVINGS OVER REGULAR WHOLESALE

OTHER TUBES AVAILABLE AT SAME LOW, LOW PRICES

Latest Code Dates • Boxed • Fully RTMA Guaranteed				Brand New Pix Tubes Full One Year Guarantee					
0Z4	.62	6AK5	1.30	6BQ7	1.42	12AU7	.85	JULY SPECIAL! 16RP4 14.95 WITH OLD TUBE	
1B3	.95	6AL5	.63	6BZ7	1.52	12BA6	.73	Old Tube	With
1X2	1.06	6AQ5	.76	6CB6	.76	12BE6	.78	10BP4	10.45 9.95
5U4	.63	6AU6	.67	6J6	.97	12SA7	.80	12LP4	12.95 11.95
5Y3	.48	6AV6	.60	6K6	.65	12SK7	.77	12LP4A	14.50 11.95
6AB4	.80	6BA6	.71	6SN7	.85	12SQ7	.67	12QP4	12.95 11.95
6AC7	1.25	6BG6	1.98	6V6GT	.75	35W4	.49	14CP4	14.95 13.95
6AG5	.83	6BK7	1.28	6W4	.70	3Z5Z	.51	15AP4	15.95 14.95
6AH6	1.40	6BQ6	1.42	12AT7	1.05	50L6	.75	16AP4	18.45 16.95
Send for FREE catalog of additional tubes and parts								16CP4A	19.45 15.95
								16DP4A	17.45 15.95
								16EP4A	20.45 16.95
								16FP4	17.45 15.95
								16GP4	20.45 16.95
								16RP4	17.95 14.95
								17BP4	20.95 16.95
								17CP4	20.95 17.95
								19AP4	23.45 19.95
								19AP4A	23.95 19.95
								20CP4	25.45 19.95
								20HP4	26.95 20.95
								21EP4	26.95 20.95
								21AP4	26.95 21.95
								21FP4	27.95 21.95

STUART ELECTRONICS DISTRIBUTORS

Dept.—R-7 Minimum Order \$10.00
TERMS: 25% Check or Money Order, Balance C.O.D., F.O.B. New York. Satisfaction Guaranteed or money back in 10 days.

149-09 Union Turnpike Flushing 67, N. Y.
Olympia 8-3553, 4352



SH!

SH!

QUIETROLE

TRADE MARK REG. U.S. PAT. OFF.

**ELIMINATES NOISE
THE SAFE[®] CLEAN WAY!**

**"The ORIGINAL
NON-INFLAMMABLE
NON-CONDUCTIVE
LUBRICANT CLEANER"**

QUIETROLE quiets noisy television and radio controls, switches* and other moving parts.

REMEMBER . . . there is NO substitute for quality . . . SH! QUIETROLE eliminates noise, the clean safe[®] way.

NO GUM! NO GOO! NO GRIME!

Carried by recognized jobbers . . . everywhere!



Available in 3 sizes:
2 oz., 4 oz., 8 oz.

*Unequaled for TV front end switches. Contains no "thinner".



manufactured by
**QUIETROLE
COMPANY**
Spartanburg, South Carolina

11.705 (moved from 15.155 for summer); and on 9.620 to U.S.-Canada 1900-2145, moved from 6.065. (Saylor, Va.)

Switzerland—United Nations Radio, Geneva, HBQ, 6.675, noted opening 1315 daily except Sat., Sun.; Eng. 1330 Mon., Wed., Fri., French Tue., Thur. *International Red Cross Committee, Geneva, tested recently on 7.210 at 0100, 1700, and at other times in various languages including English.* (Pearce, England) During summer, Berne is using only 6.165, 7.210, 9.535 to North America 2030-2300. (Foster, Ill., others)

Taiwan—H. P. Tsong, acting general manager for Broadcasting Corporation of China (Taiwan), has sent Scheiner, N. J., these complete schedules for stations operated by the Corporation—"Voice of Free China," Taipei, 2200-0100 to America, mainland China, Korea, Japan, South Sea Islands, Southeast Asia, BED3, 15.235, BED6, 11.736 (50 kw.), (English 2205-2230, 2335-0000); 0530-1200 for mainland China, Japan, Korea, South Sea Islands, Southeast Asia, BED6, 11.736 (50 kw.), BED7, 7.130 (20 kw.) from 0800; 1400-1600 for Europe and Near East (English 1420-1445), BED4, 11.920 (20 kw.). Armed Forces Radio Station, BEC22, Taipei, 7.000, 1.5 kw., Chinese; BED24, Kachsiung, 11.350, 1.5 kw., Chinese; BEC26, Tso-Ying, 10.300, 1.5 kw., Chinese for local area and Chinese mainland, all at 1730-1030. Broadcasting Corporation of China (Home Service), Taipei, BED29, 6.095, 3.5 kw., Chinese 1730-1030. "The Voice of Justice," Taipei, in Chinese, BEC36, 7.300, 3 kw., 1700-1230. The Japanese Short Wave Club says BED29, 6.095, has English daily except Sat. 1800-1850 parallel m.w. 860 kc., announces "This is the Taiwan Broadcasting Station in Taipei." Morgan, Calif., notes BED32, 9.785A, at 0320 with woman in Chinese.

Tangier—VOA's relay of *Radio Maroc*, Rabat, 15.205, noted opening 0730, woman in English, man in French and Arabic; then had Arabic vocal music; 0800 news in Arabic; closed 0930. (Pearce, England, others) "Radio Voice of International Evangelism, Tangiers," near 7.305, heard opening in English and Spanish 1500, closed 1600; says on air 0800-0900 Sun., 1500-1600 weekdays. (Pearce, England) Heard in N. Y. closing 1604A, weak level. (Bellington) The Danish commercial station, *Danmarks Reklame Radio*, Tangier, has been heard again in Britain on 7.300A at 1615. (Radio Sweden)

Thailand—Heard in Australia with news in Thai 1900 on HSK7, 11.910A. (Sanderson)

Turkey—By this time, *Radio Ankara* should be using 15.160 instead of 7.285, parallel 9.465, for English to Western Europe-Britain 1600-1645. *Technical University of Istanbul*, 7.030, tuned 1435 when had classical music; off 1502 with orchestral selection. TAV, 17.825, noted opening to Southeast Asia 0830, off 0915. (Pearce, England) TAT, 9.515, still good to North

America in English 1815-1900. (Strong, Md., others)

Uganda—*Radio Kampala* is scheduled 1000-1230 on 5.026. (ISWC, London) Is now using 500 watts, to be increased to 11 kw. later this year.

USI (Indonesia)—YDF6, 9.710, Djakarta, noted with recorded popular tunes, woman in English, 0630-0700, then with Chinese-language session in beam to Australia-New Zealand-Philippines. (Bulmur, Brt. Columbia) Has news 0615, good level in Va. (Saylor) Excellent in English 0930-1030. (Kapp, Calif.) Heard over YDF8, 9.865, 1330 with call in Dutch, popular musicals; 1400-1500 in English; parallel on 11.785A. (Pearce, England)

USSR—Noted with English 1400-1630 on 9.74, 9.595, both good level. (Balbi, Calif.) Heard on measured 9.736 in English 1500, closed 1557. (Ferguson, N. C.) Heard on 7.215A at 1800 with news at strong level. (Winthrop, N. Y.) Noted on 9.735A with English for Europe at 1432 tune-in. (Bellington, N. Y.) Home Service heard on 11.840A at 2200-2400. (Bulmur, Brt. Columbia; Morgan, Calif., others)

Yugoslavia—*Radio Belgrade* noted with news 1330-1345, 1745-1800 on 7.200, 6.100. (Pearce, England)

Press Time Flashes

The NNRC reports that a low-powered station will be opened in the 6-mc. band sometime during the year on Tarawa in the Gilbert and Ellice Islands group; the information came to Legge, N. Y., from C. W. Adams, Chief Wireless Officer, Betio, Tarawa Island, who operates amateur station VR1A in the 20-m. ham band.

Radio Athens sent schedule of 0215-0630, 0700-0800, 1000-1100, 1130-1145, 1200-1300, 1330-1430, all on 9.607; 0830-0945 on 6.177. TAZ, Izmir, Turkey, listed for 6.600, noted nearer 6.525 recently 1145 with Western popular music; at 1200 relayed news in Turkish from long-wave TAR, Ankara. (Pearce, England)

WRUL officials say that recently added goodwill broadcasts have received high commendation from listeners in North America, Latin America, Europe, and Asia; listener response has increased to such an extent that some of the public service programs—such as news reports and stock market reports—have attracted new sponsors. station officials advise.

New schedule for *Radiodiffusion National Khmere*, Phnom Penh, Kingdom of Cambodia (Indo-China) received direct from station officials lists 6.090, 10 kw. (has increased power), at 1900-2000, 0000-0200, 0600-0915. (Scheiner, N. J.) By this time Israel's new 50 kw. (Israeli Post Office) transmitter should be in use by Tel Aviv. *Radio Sweden's summer* schedule is 0600-0645, 15.155; 0700-0745, 0800-0845, 0900-1045, 1100-1145, 11.705; 1200-1245, 1300-1400, 15.155; 1800-2100, 9.535; 1800-1845, 11.705; 1900-2145, 9.620; 2200-2245, 2300-2345, 0000-0045, 11.705; 0100-0200, 15.155; European Service 1500-1700, 6.095; "Sweden Call-

GREATEST TUBE BUYS

Every Tube **GUARANTEED 6 Months**

BRANDED—BULK PACKED IN ORIGINAL MFR'S NESTED CARTONS OR INDIVIDUALLY BOXED

EVERY TUBE METER & CHASSIS TESTED FOR TOP QUALITY

OA4G ..\$.50	1U4\$.46	6BF5 ...\$.69	6SQ7GT \$.37	7X6\$.57	19BG6G \$1.15
OZ449	1U538	6BG6G . 1.10	6SR749	7Y440	19T861
1A4P35	1X2A65	6BH645	6T857	7Z445	2235
1A530	2A539	6BJ646	6U749	12A639	25AV5 ... 1.05
1A7GT45	2A735	6BL7GT . .65	6U859	12A798	25BQ6GT .75
1B3GT65	2X239	6BN688	6V3 1.04	12AT6 .. .31	25L6GT . .40
1C5GT39	3LF471	6BQ6GT . .69	6V6GT38	12AT7 .. .57	25Z6GT . .37
1C7G35	3Q448	6BQ788	6W4GT41	12AU634	32L7GT . .39
1D7G35	3Q5GT48	6C431	6W6GT41	12AU759	3329
1E7GT35	3S446	6C5GT41	6X435	12AV760	3429
1F435	3V446	6C649	6X5GT33	12AX7 .. .62	35-5135
1F5G39	5U4G49	6CB642	7A445	12AY7 .. .72	35B538
1H4G35	5V4G76	6CD6G . 1.05	7A745	12BA652	35C538
1H5GT38	5Y3G36	6E576	7B546	12BA7 .. .61	35L6GT . .42
1J688	6A635	6F645	7B645	12BD646	35W432
1L447	6A8GT63	6H6GT49	7B745	12BE6 .. .40	35Z5GT . .49
1L661	6AB769	6J5GT34	7C753	12BH741	3632
1LA477	6AC768	6J650	7E580	12H649	3732
1LA675	6AG546	6J749	7E660	12SA7GT .58	39-4435
1LB477	6AH688	6K6GT36	7E780	12SG761	4635
1LC575	6AK569	6K7G49	7F764	12SH749	4775
1LC675	6AL534	6L6GA99	7F892	12SK749	4932
1LD575	6AQ537	6Q7GT51	7G780	12SN7GT .46	50B541
1LE375	6AQ636	6S447	7H756	12SQ749	50C541
1LG575	6AQ7GT . .69	6SA759	7J780	12SR749	50L6GT . .59
1LH475	6AS562	6SA7GT . .61	7K780	12Z339	117Z339
1LN575	6AT636	6SC781	7L780	14A753	117Z6GT .70
1N5GT61	6AU636	6SF5GT . .58	7N757	14AF763	9003 ... 1.10
1Q5GT39	6AV5GT . .79	6SG759	7Q757	14B645	801A35
1R481	6AV636	6SH765	7R759	14C580	803 2.95
1R546	6BA633	6SJ754	7S785	14C765	814 3.50
1S440	6BA757	6SK7GT . .39	7V787	14E665	836 7.95
1S538	6BC546	6SL7GT . .49	7W794	1935	866A ... 1.45
1T446	6BE637	6SN7GT . .46			

Minimum Order: \$10.00. Terms: 25% with order balance C.O.D. Please include postage.
All prices subject to change without notice. F. O. B. New York City. Mail Order Division:

TRANSAMERICA ELECTRONICS CORP.

115 Liberty Street New York 6, N. Y.

AIREX'S HI-FIDELITY

1954 INTERCARRIER 630FA-3
WITH TONE CONTROL & FRONT FOCUS
READY FOR COLOR CONVERTER

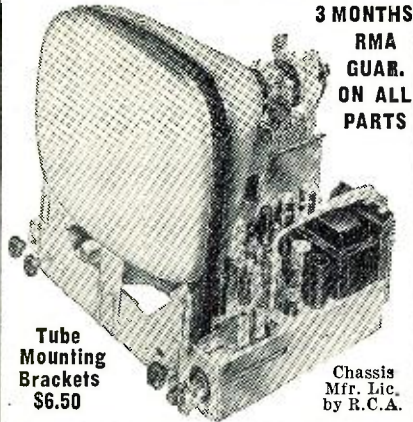

3 MONTHS
RMA
GUAR.
ON ALL
PARTS

Tube
Mounting
Brackets
\$6.50

Chassis
Mfr. Lic.
by R.C.A.

Here is the most powerful fringe area chassis on the market today . . . the one TV engineers and servicemen are buying for themselves. Clear, sharp, exceptional reception up to 200 miles.

THE ONLY CHASSIS WITH 10 WATT PUSH-PULL HI-FI AUDIO SYSTEM AT

\$164⁹⁵

Fed. Tax
Included

Less C.R. Tube
and Brackets

Complete with Two Speakers—12" Hi-Fi
Woofer and Tweeter
With UHF 83 Channel Converter—\$211.90
Detailed Service Manual & Schematic—\$1

Write for FREE Descriptive Folder

COMBINATION SAVING!

This Month
Only

- 630 FA-2A Chassis
 - 21" Picture Tube
 - Mah. Console Cabinet
- With mask, glass, tube mtg brackets **FOR THE 3 UNITS**

\$244⁹⁵

Fed. Tax
Incl.

TV PICTURE TUBE SALE

Standard Brands. Factory
New. Guar. 1 year.

- 17" Tube. . . . \$24.95
 - 20" Tube. . . . \$32.95
 - 21" Tube. . . . \$34.95
 - 24" Tube Round
(Guar. 6 Mos.) \$79.95
 - 24" Tube Rect. \$59.95
 - 27" Tube Rect. \$79.95
- Guar. 6 months
• Ring and Sleeve
for 24" Round. \$ 7.50

Techmaster- **\$139⁹⁵**
C30 Chassis

Techmaster **\$214⁹⁵**
2430-9
Chassis. 24"
& 27" Rect.

TV GOLD PLASTIC MASKS

- 16" and 17" . . . \$ 4.95
- 20" and 21" . . . \$ 7.95
- 24" . . . \$14.95
- 27" . . . \$17.95

Granco 82chan.
UHF Tuner. . . **\$18.95**

CABINET BUY

Mahogany console cabinet cut for 630 FA-2A Chassis. With mask, glass & tube mount. . . **\$49.95**
In Blond . . . \$59.95
FREE cabinet brochure

WEBSTER CHANGER

3 speed with dual needle, Titone cartridge and built-in nylon record cleaner brush. . . **\$24.95**
Mfrs. surplus..

We Won't Be Beat on Hi-Fi Equip.

REGAL FM-AM RECEIVER



10 Tubes. Covers full FM-AM band. 10 Watt Push-pull audio output. Separate bass and treble controls. Built in FM-AM antenna. With 12" Hi-Fi speaker \$5 additional

\$49⁹⁵

Also complete line of Tuners, Amplifiers, Speakers, Phono Pick-Ups and Cartridges and Changers

- Aitec
- Astatic
- Bogen
- Craftsmen
- Electrovoice
- Espy
- Fisher
- Garrad
- Gen'l Electric
- Grommes
- Jensen
- Pickering
- Pilot
- RCA
- University
- V-W
- Webster
- Wharfedale

Send us your requirements. Full, illustrated catalog available.

All merchandise brand new, factory fresh, guaranteed. Mail & phone orders filled upon receipt of certified check or money order for \$25 as deposit on TV chassis. 20% on other items. Balance C.O.D., F.O.B. factory N. Y. Prices & specifications subject to change without notice. NO FED. TAXES TO PAY.

AIREX RADIO CORP.

SHOWROOM: 171 Washington St., N. Y. 7
Cortlandt 7-5218

ing DX-ers" is Fri. 1045, 1730, Sat. 0215 on 6.065. Station officials of *Radio Belize*, Brt. Honduras, have informed Gay, Calif., that the 6.100 outlet is now operating 1300-1500, 1900-2200 daily.

Radio France-Asie, Saigon, Indo-China (Vietnam), has been lately on 9.625A instead of 9.75A with *English* 1100 for Europe; closes 1127A with "La Marseillaise." "Voice of Vietnam." Saigon, is weak now on 6.17, and the 9.625 outlet has QRM from XEBT, Mexico, during 0930-1000 *English* news session. (Balbi, Calif.)

Summer schedules of *Radio Japan* are 0000-0100, 15.135, 11.780; 0200-0300, 15.135, 11.780; 1800-1900, 15.135, 11.780; 0400-0500, 15.135, 11.780; 0530-0730, 11.705, 9.675; 0900-1000, 15.235, 11.705; 0745-0845, 11.705, 15.235; 1000-1100, 11.705, 15.235; 1115-1215, 11.705, 15.235; 1230-1330, 11.705, 9.675; 1400-1500, 11.705, 9.675. (Cisler, Calif.; Hakansson, Sweden, others)

Acknowledgment

Thanks for the fine reports, fellows! Keep them coming to Kenneth R. Boord, 948 Stewartstown Road, Morgantown, West Virginia, U.S.A. K.R.B.

Spot Radio News

(Continued from page 20)

As to the actual techniques available, the consultant went on, they include card, coin, line, air-code, cash and credit systems, and in a variety of combinations.

In his opinion subscription TV will be quite a project. "To develop this new—and enormous—market will be no penny-ante proposition," he emphasized. "It will call for a lot of techno-

logical know-how; a vast amount of production and sales engineering; ample production facilities; a lot of merchandising skill, courage and imagination and finally a barrel of risk money."

FOR THE FIRST TIME since the freeze lift in July, 1952, no station grants were issued during an entire week; the last week in April. A number of factors were responsible; fewer applicants, complexity of hearings now under way and the confusing ultra-high picture.

Before the lull and a week after, business picked up and several new approvals were issued. A listing of the new grants appears at the bottom of this page.

THE INVENTOR of the remarkable radar-mapping device, known as the plan-position indicator or PPI, Dr. Robert M. Page, associate director for electronics at the Washington, D. C. depot of NRL, has finally received official recognition. He has been awarded patent 2,677,127.

PPI gives a radar operator a complete picture of the area searched or swept by his set on a CRT. During the war, the device enabled gunners and bombers to hit unseen targets, detect enemy ships and aircraft, and navigate ships under unfavorable weather conditions. Today, this device aids in landing airplanes at fog-shrouded airports, assists in the navigation of commercial liners and smaller craft, and also helps meteorologists to forecast and track hurricanes.

Everyone is grateful indeed to this eminent scientist for his brilliant invention, which has played so vital a role in the affairs of the military and our daily lives. L.W.

NEW TV GRANTS SINCE FREEZE LIFT

Continuing the listing of constructive permits granted by FCC since lifting of freeze. Additional stations will be carried next month.

STATE	CITY	CALL	CHANNEL	FREQUENCY (mc.)	POWER* (Video)
California	San Jose	11	198-204	178
Kansas	Wichita	KAKE-TV	10	192-198	316
Kentucky	Lexington	WLEX-TV	18	494-500	171
Michigan	Marquette	6	88-94	24.5
Missouri	St. Louis	KWK-TV	4	86-72	100
New York	Buffalo	2	54-60	100
North Carolina	Fayetteville	WFLB-TV	18	494-500	94
	Gastonia	WNSC-TV	48	674-680	14.4
Oklahoma	Muskogee	KTVX-TV	8	180-186	316
Washington	Seattle	20	506-512	200

NEW CALL LETTER ASSIGNMENTS

Alabama	Selma	WLSA	8	180-186
Arkansas	El Dorado	KRBB	10	192-198
California	El Centro	KPIC-TV	16	482-488
Idaho	Nampa	KTVI	6	82-88
Kansas	Great Bend	KCKT	2	54-60
New York	Buffalo	WGRB	2	54-60
	Carthage	WGRB-TV	7	174-180
South Carolina	Florence	WBTW	7	180-186
South Dakota	Rapid City	KTLV	8	174-180
Texas	Houston	KTLJ	13	210-216
Virginia	Newport News	WACH-TV	33	584-590

*ERP = (effective radiated power, kw.) . . = Call letters to be announced

FREE!

THE HOTTEST VALUE-
PACKED BULLETIN
IN THE MAIL!

Over 153,000 subscribers
buy and save through
**WHOLESALE RADIO'S
F.Y.I.
BULLETIN**
EVERYTHING
IN RADIO • TV
HI-FI SOUND

Write For Issue #132

**WHOLESALE
RADIO PARTS CO., INC.**
311 W. Baltimore St., Baltimore-1, Md.

New EICO PROBES



SCOPE PROBES

SCOPE DEMODULATOR PROBE
KIT \$3.75 WIRED \$5.75

LOW CAPACITY PROBE
KIT \$3.75 WIRED \$5.75

DIRECT PROBE
KIT \$2.75 WIRED \$3.95

SPECIAL
ALL 3
SCOPE
PROBES
Kit... \$9.95
Wired \$14.95

VTVM PROBES

VTVM RF PROBES
KIT \$3.75 WIRED \$4.95

PEAK-TO-PEAK PROBES
KIT \$4.95 WIRED \$6.95



SENSATIONAL HIGH VOLTAGE PROBE
Model HVP-2
ONLY... \$4.95

See these amazing probe values at your jobber today. Write now for FREE catalog RP7. Read EICO'S other ads in this issue—turn to Advertisers Index!

EICO® PAT. APP. FOR
ELECTRONIC INSTRUMENT CO., Inc.
84 WITHERS STREET, BROOKLYN, NEW YORK

Technical BOOKS

"TV MANUFACTURERS' RECEIVER TROUBLE CURES" edited by Milton S. Snitzer. Published by John P. Rider Publisher, Inc., New York. 109 pages. Price \$1.80. Paper bound.

This is the fifth in this publisher's current series of handbooks for service technicians.

The new volume covers receivers manufactured by *Sparton, Stewart-Warner, Stromberg-Carlson, Sylvania, Tele-King, Trad TV, Transvision, Traveler, Wells-Gardner, Western Auto ("Truetone"), Westinghouse, and Zenith.*

Like the previous volumes in this series, the pertinent information is presented completely but concisely and remedial procedures are described in detail.

* * *

"THE MAGIC OF ELECTRONICS" by Edward J. Bukstein. Published by Frederick Ungar Publishing Co., New York. 251 pages. Price \$3.95.

This book is a "survey" of the entire field of electronics, presented in the form of brief, non-technical essays. Since the scope of this work is so vast the treatment is, of necessity, abbreviated.

The author, a frequent contributor to this magazine, discusses such topics as the electron tube, industrial process and control operations, electronic medical devices, detectors and counters, safety and communications equipment, industrial television, Geiger and scintillation counters, the transistor and its applications, test equipment, and other units of similar type in widespread use.

For the layman whose interest in electronics has been stimulated by newspaper stories and articles in popular magazines, this book will go a long way towards satisfying his curiosity as to what makes electronics "tick."

* * *

"AUTOMATIC RECORD CHANGER SERVICE MANUAL" by Sams Staff. Published by Howard W. Sams & Co., Inc., Indianapolis. Price \$3.00. Vol 5. Paper bound.

This is the fifth volume in the current Sams series covering not only record changers but multi-speed changers, and tape recorders. This volume covers equipment made during 1952-53.

Products of *Admiral, Ampex, Brush, Collaro, Crescent, DuKane, Ekotape, Knight, Magnecord, Masco, Pentron, Revere, Tape Master, V-M, Webster-Chicago, and Wilcox-Gay* are included.

As was the case with the previous releases in this series, data on each unit includes a photograph, general information, an "exploded" view, operating instructions, parts list, and service data.

A cumulative index covering all five volumes is also included to facilitate locating material about the unit on the shop bench. Service technicians will

3 SHURE

CRYSTAL PICKUP CARTRIDGES

replace the 192

cartridges you are most likely to encounter in your service work!

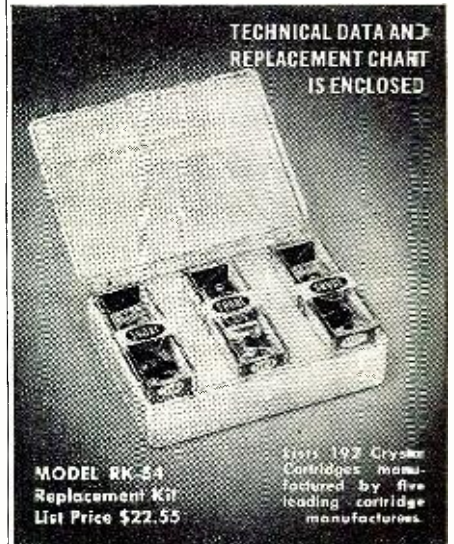

MODEL RK-54
Replacement Kit
List Price \$22.55

TECHNICAL DATA AND
REPLACEMENT CHART
IS ENCLOSED

These 192 Crystal
Cartridges manu-
factured by five
leading cartridge
manufacturers.

Lowest investment for broadest coverage! The RK-54 is beyond all doubt the *most practical* Replacement Kit on the market! Proof? Simply this—you get the broadest coverage at the lowest investment—only \$22.55 list! Think of it—3 Crystal Cartridges replace 192 of those specific Cartridges most likely to be in need of replacement! Two of the Cartridges consistently have been "best sellers" in the Shure line—as established by actual sales to Servicemen! The Cartridges are: Model W22AB, 3-Speed, 2-Needle Cartridge—Model W26B, All-Purpose, Single-Needle Cartridge—Model W78, 78 RPM, Dual-Volt, Dual-Weight Cartridge. Model W78 is the new, versatile Cartridge that replaces 149 other Cartridges. This Cartridge alone will become a sensation overnight! Order a Replacement Kit from your Distributor today—once you have worked with this practical kit you will find that these three Cartridges are dependable replacements—will make your service work faster, easier and more profitable!



TRANSPARENT
PLASTIC BOX
IS FREE!

This Handy Box is
5" long, 3½" wide,
1¼" deep.

SHURE

*The Mark
of Quality*

Here's a **TERRIFIC BUY** for
MOBILE HAMS!



FAMOUS BC-645
Transmitter-Receiver

BRAND NEW! Makes wonderful mobile rig for 420-300 Mc. Easy to convert for phone or CW 2-way communication. CONVERSION DIAGRAM INCLUDED. This swell rig originally cost over \$1000—yours for practically a song! You get it all, in original factory carton, **BRAND NEW**, complete with 17 tubes, less power supply. **\$29.50** Shpg. wt. 25 lbs.

PE-101C DYNAMOTOR for BC-645, has 12-24V input (easy to convert for 6V Battery operation, instructions included)..... **\$4.85**

UHF ANTENNA ASSEMBLY, for BC-645 **\$2.45**

CONVERSION BOOKLET, Instructions for most useful surplus rigs..... **\$2.50**

HEADSETS	Excellent USED	BRAND NEW
HS-23 high impedance.....	\$2.25	\$4.45
HS-33 low impedance.....	1.79	5.45
HS-30 low imp (featherwt).....	1.49	2.22
H-16/U high imp (2 units).....		7.95
CD-307A cords, with PL55 plug and JK26 jack, 8' long.....		.99

MICROPHONE BARGAINS

T-44 Mike	Brand New \$1.19
T-45 Navy Lip Mike	Brand New \$1.49
T-17 Carbon Hand Mike	Brand New \$7.95
T-30 Carbon Throat Mike	Brand New \$.69
T-24 Single Button Carbon Mike.....	Brand New \$3.95

SCR-274N COMMAND and ARC-5 EQUIPMENT
All Complete With Tubes—Prices Slashed!

Type	USED	Excellent BRAND NEW
BC-453 Revr. 190-550 Kc.....	\$18.50	\$44.50
BC-454 Revr. 3-6 Mc.....	9.25	21.95
BC-455 Revr. 6-9 Mc.....	8.95	16.50
BC-456 Modulator		2.75 5.75
BC-457 Xmtr. 4-5.3 Mc.....	12.50	16.50 24.50
BC-458 Xmtr. 5-3-7 Mc.....	7.95	9.75 23.50
BC-459 Xmtr. 7-9.1 Mc.....	12.95	14.25 22.50
BC-696 Xmtr. 3-4 Mc.....	18.95	29.95
BC-450 3-Rev. Control Box		1.99
BC-451 Xmtr. Control Box.....		1.25 1.49
3-Receiver Rack		1.79 2.95
2-Transmitter Rack		1.59 3.25
Single Transmitter Rack.....		3.25

ARC-5/T-23 Transmtr, with crystals, tubes, circuit diagram. Brand New \$39.50

ARC-5 MARINE RECEIVER-TRANSMITTER
Receiver 1.5 to 3 Mc. BRAND NEW, each \$22.50
Transmitter 2.1 to 3 Mc. BRAND NEW, each **24.45**

Combination Transmitter and Receiver, complete with tubes. NEW! **45.00**

BEACON RCVR BC-1206-C

Complete with 5 tubes. Tunes 195 KC to 420 KC. IF Frequency—135 KC. Receiver Sensitivity—3 Microvolts for 10 Milliwatt output. Output Impedance—300 Ohms and 4000 Ohms. Volume Control—RF Gain Control. Power Supply—24-28 Volts Aeroplane Battery, Current—75 Amperes. **\$12.95**
BRAND NEW

GOULD 6-VOLT STORAGE BATTERY

Navy Standard, Black Rubber Case. BRAND NEW. 15 Amp. Hour Rating **\$6.95**



GOULD 4-VOLT LEAD STORAGE BATTERY

(2 Cell) 16 Amp. Hrs. Portable Metal Case..... **\$3.95**

WILLARD 6-VOLT MIDGET STORAGE BATTERY

3-amp hr. BRAND NEW. 35/8" x 1-13/16" x 23/8". Uses standard electrolyte **\$1.95**

WILLARD 2-VOLT STORAGE BATTERY.

20 AMP. HR. BRAND NEW..... **\$2.69**
1-Qt. Electrolyte, enough for two cells..bottle \$1.45

DYNAMOTORS

Type	Input	Output	Exc. Used	Brand New
DM-32A	28V 1.1A.	250V .05A.	\$4.99	\$7.50
DM-33A	28V 5 A.	575V .16A.	1.95	3.49
	28V 7 A.	540V .25A.		
DM-40	14V 3.4A.	172V 1.38A.		3.95
DM-28	28V	224V .07A.	2.25	4.95
PE-73	28V 20A.	1000V .350A.	9.50	12.50

Please include 25% Deposit with order—Balance C.O.D. MINIMUM ORDER \$3.00. All Shipments F.O.B. Our Warehouse N.Y.C.

G & G Radio Supply Co.
Dept. N-7
51 Vesey St., New York 7, N. Y., CO 7-4605
Branch: 16 W. Kinzie St., Chicago, Ill.

find that such volumes on their reference shelves will expedite their service jobs and save both time and money.

* * *
"AN INTRODUCTION TO RADIO AND TELEVISION" by D. C. Phillips, J. M. Grogan & E. H. Ryan. Published by *The Ronald Press Co.*, New York. 407 pages. Price \$5.00.

This is a practical manual for those interested in the programming end of radio and television. It is a "how-to-do-it" book covering announcing, acting, programming, directing, writing, and newscasting.

Since this text is the work of three men of varied experience in actual telecasting and broadcasting operations, the book is meaty and down-to-earth.

* * *
"BEGINNING TELEVISION PRODUCTION" by Melvin R. White. Published by *Burgess Publishing Co.*, Minneapolis. 103 pages. Price \$2.50.

This is a workbook for students of speech, drama, and radio and is designed to be used in colleges and schools where radio and TV courses are offered.

It covers such topics as the problems of black and white TV, production personnel, studio and equipment, lighting for TV, TV sets and properties, etc.

Instructors in TV production should find this manual of assistance in setting up a well-balanced course. —50—

TVI Troubleshooting

(Continued from page 55)

1. Remove the antenna of the offended set as far as possible from other antennas.

2. Remove the transmission line of the offended set away from other transmission lines.

3. In cases where the interference is so strong that it causes the picture to go negative, the use of an attenuator pad in the antenna input will decrease this effect noticeably. The *Centralab* printed circuit H-type pads are quite useful for this purpose. In fact, such a pad might also be used even if the TVI is not causing overload but is quite severe. In any case, it would be wise to try several values of attenuation before settling on one.

4. Avoid placing TV sets close to one another. Investigate the possibility in apartment houses of an offending set being back-to-back, through an apartment wall, with the set with the TVI.

Video i.f. harmonics. Interference from this source is tunable and unmodulated. Cures usually take the form of chokes in the "B+" and heater leads that go back to the tuner, correcting the lead dress, filtering of the detector output and, in some cases, of the video amplifier output. In the event that the leads to the CRT are very long, it is advisable to place a choke in series with the lead that carries the video signal to the CRT. This choke should be located below the chassis, and should be resonant at the frequency of the harmonic that is giving the trouble.

Intercarrier sets do not suffer as much from the effects of these harmonics because it is possible to tune away from the beat and still get satisfactory reception. For split-channel sets, the simplest and most positive cure is to change the i.f. alignment so that the harmonic will either fall out of the band altogether, or else will be so far away from the carrier that it will cause no trouble. Field experience has proven this to be the most satisfactory method of eliminating the beat once and for all.

High channel interfering with low channel. In most cases, the interference is due to the video carrier of the high channel TV station. The video carrier mixes with the second harmonic of the oscillator (set for the low channel) to produce a signal in the i.f. range. If the signal is strong enough, the actual interfering video signal will sweep back and forth across the desired signal. However, in most cases, a diagonal line pattern will result.

The basic problem involved is to attenuate the video signal that is producing the interference. Probably the simplest way to do this is to use a stub. One end of the stub, which is nothing more than a length of 300-ohm transmission line, is connected in parallel with the transmission line at the input to the receiver; the other end is left open. The stub should be electrically equivalent to a quarter-wave-length of the frequency that it is desired to attenuate. This results in a short circuit across the antenna input at the frequency of the interfering signal. Table 2 presents the approximate lengths for each undesired signal. These lengths are slightly longer than normally required to allow these stubs to be cut with a pair of diagonal cutters while watching the picture for the most effective elimination of the interference. (To be continued)

Table 2. The video carriers of the high channels shown here may mix with the second harmonic of the low-channel oscillator frequency to produce an interfering i.f. The correct stub connected to the receiver input, as described in the text, will correct this condition. The last line gives a TVI possibility for a 40 mc. i.f. set.

INTERFERED CHANNEL	INTERFERING CHANNEL AND FREQUENCY	APPROXIMATE STUB LENGTH	
2	9	187.25 mc.	20 inches
3	11	199.25 mc.	18 inches
4	13	211.25 mc.	16 inches
5	8	181.25 mc.	22 inches
6	10	193.25 mc.	19 inches
4	8	181.25 mc.	22 inches

Mac's Service Shop
(Continued from page 66)

crystal markers for every channel, etc., is pretty well wasted on the average technician. Far too much of this manufacturer-prepared service information sounds as though it were written to impress a competitor's engineering staff rather than to aid the technician."

"Maybe we ought to have some kind of standardization of service instruments," Barney suggested.

"That would be a good idea if it could be worked out. For example, if various service instrument manufacturers and set manufacturers could get together and decide what instruments are essential for modern service work and what minimum specifications for those instruments should be, that would be an excellent first step. Then service instructions could be prepared around these standardized instruments. Furthermore, a technician buying a piece of test equipment would only need to compare the specifications of the instrument being considered with the standard specifications to know whether or not he could rely on it to do the job.

"He does not know that now. I was reading a couple of months back where an experimenter checked six different commercial sweep generators and found only one make had sufficiently good linearity, flat response, and adequate sweep to warrant its use without making allowance for errors—and that one cost over four hundred dollars! In using the other five, the technician had first to identify the shortcomings of the particular instrument and then to take these peculiarities into account in observing every trace produced with it. That's like trying to hunt with a rifle that shoots several degrees to the left of where the sights point. You may be able to do it, after a fashion, but it'll not be easy."

"What's all that to do with test tapes?" Barney demanded.

"Keep your shirt on; I'm coming to that," Mac retorted. "I keep thinking that what is really needed in TV service is a signal generator that will produce a real honest-to-gosh TV signal in the same way our AM signal generator produces an actual radio signal. Now that a complete television program can be recorded in black and white or color on a single tape, I believe we are in striking distance of this ideal. First we shall need a couple of oscillators representing video and audio carriers whose frequencies can be adjusted to the carrier frequencies of any channel. Then the video oscillator will be AM modulated with the picture information on the tape and the audio oscillator will be FM modulated with the tape's audio track. The output of the oscillators will be combined, controlled, and fed to the antenna terminals of the TV set being tested.

"The picture information on the tape can contain any type of information

July, 1954

Pay Only 10% Cash Down
18 Months to Pay on Major Equipment



LEO I. MEYERSON
W6GFO

Now it is easier than ever to buy from WRL. Pay as little as 10% down and the balance in 18 months. No red tape—we handle our own financing. We will give you a generous trade-in allowance on your present equipment. We have over 600 reconditioned used items—with new factory guarantee. Send for free list. You will profit most when you deal with WRL—THE WORLD'S MOST PERSONALIZED RADIO SUPPLY HOUSE and THE WORLD'S LARGEST DISTRIBUTOR OF AMATEUR RADIO TRANSMITTING EQUIPMENT.

HALLICRAFTERS S-40B \$119.95



\$9.54 Per Month
(12 months)

\$12.00 CASH DOWN

Communication receiver with built in speaker covering 540-Kc to 44 Mc in four bands. One RF stage, 2 IF stages.

HALLICRAFTERS SX-71 \$249.95



\$13.63 PER MONTH **Cash Down**
(18 Months) **\$25.**

Double Conversion sharp selectivity, plus built-in NBFM at moderate cost. 11 tubes plus voltage regulator and rectifier. Low down payment.

HALLICRAFTERS RECEIVERS AVAILABLE FOR IMMEDIATE SHIPMENT

MODEL NUMBER	12 MONTHLY PAYMENTS	DOWN PAYMENT	CASH PRICE	MODEL NUMBER	18 MONTHLY PAYMENTS	DOWN PAYMENT	CASH PRICE
S-38C	\$3.97	\$ 5.00	\$ 49.95	S-76	\$10.90	\$20.00	\$199.95
S-53A	\$7.95	\$10.00	\$ 99.95	SX-62	\$19.07	\$35.00	\$349.95
S-72 Port	\$8.74	\$11.00	\$109.95	SX-71	\$13.62	\$25.00	\$249.95
S-77A	\$9.54	\$12.00	\$119.95	HT-20XMTR	\$24.50	\$44.95	\$449.50



FREE
1954
CATALOG

Get your BIG NEW 1954 WRL CATALOG, offering the greatest selection of radio and television equipment, parts and supplies for the Novice, Experimenters, Hams and Professionals.

WRITE FOR DETAILED EQUIPMENT SPECIFICATION SHEETS



WRITE—WIRE—PHONE 2-0277 COUNCIL BLUFFS, IOWA

WORLD RADIO LABORATORIES
3415-27 W. Broadway
Council Bluffs, Iowa

R-7

Please send me:

- 3' x 4' U.S. Radio Map 25c
 New Catalog
 Used Equipment List
- WRL XMTR Info
 SX-71 Info
 S-40B Info
 NEW LOG BOOK 25c

Name

Address

City State

SPEAKER RECONING

Complete line Cones, Spiders, Rings and Voice Coils. Custom Built Voice Coils. Low prices. Write for Parts List and Reconing information.

WESTERN ELECTRONICS CO.

3164 West Colfax Denver 4, Colo.

BARGAIN HUNTING? **RADIO SERVICEMEN!**
Write for SENSATIONAL CATALOG
HENSHAW RADIO SUPPLY
3619 TROOST KANSAS CITY, MO.

GET INTO ELECTRONICS

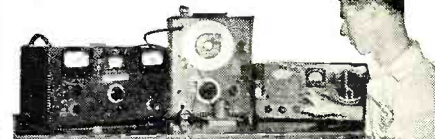

You can enter this uncrowded, interesting field. Defense expansion, new developments demand trained specialists. Study all phases radio & electronics theory and practice: TV; FM; broadcasting; servicing; aviation, marine, police radio. 18-month course. Graduates in demand by major companies. H.S. or equivalent required. Begin Jan., March, June, Sept. Campus life. Write for catalog.

VALPARAISO TECHNICAL INSTITUTE
Dept. RD Valparaiso, Indiana

SPECIAL OF THE MONTH

WESTON MODEL 301—3" Round Bakelite Case. 1000 ohms per volt (0-1 Ma) 0-50 Volt DC scale. Multiplier removes easily. **\$4.95 ea.**
A TERRIFIC BARGAIN AT.....

PLATE TRANSFORMER BARGAIN

Made by Chicago Trans. Co. 3000-0-3000 Volts RMS, @ 300 Ma. Primary 115V., 60 Cy. Type FS. Full case. Pri. tapped to reduce voltage to 2500 V. RMS. BRAND NEW, BOXED IN ORIGINAL CASES. A TERRIFIC VALUE AT..... **\$29.95 ea.**

MOBILE DYNAMOTORS

Made by Pioneer. Input 6 VDC. Output 400 V. @ 175 Ma. Mounting bracket attached. Removed from equipment. All checked and guaranteed. This is your chance to get a small rugged Dynamotor at only..... **\$12.95**

WESTON METERS

0-150 VAC Rectifier type..... Model 301	\$7.95
0-100 V.D.C. (1000 ohms/v).....	5.95
0-10 Volts DC (1000 ohms/v).....	5.95
0-1 Ma (K Scale).....	5.95
0-10 Ma DC.....	5.95
0-150 Ma DC.....	5.95
0-1.5 Mills DC.....	5.95
0-200 Microamps (Scale)..... Model 731	7.95
0-1 Ma (0-100 Scale).....	6.95

PANEL METERS

GOVT SURPLUS, G.E., WESTINGHOUSE, WESTERN ELECTRIC, SIMPSON, ETC.

2" METERS		3" METERS	
100-0-100 Microamps	\$5.95	0-500 Microamps	\$5.95
0-80 ma DC.....	3.49	0-50 Mill.....	4.50
0-15 ma DC.....	3.49	0-80 Mill.....	4.50
3" METERS		0-150 Volts AC.....	6.95
0-200 Microamps.....	\$6.95	0-300 Volts AC.....	6.95
0-400 Microamps.....	5.95	0-3 Amp RF.....	6.95
0-500 Microamps.....	5.95	0-5 Amp RF.....	6.95
0-200 Milliamp.....	4.50	0-6 Amp RF.....	6.95
0-250 Milliamp.....	4.50	0-20 Amp RF.....	6.95
0-1000 Milliamp.....	4.50		

MANY OTHER METERS IN STOCK. PLEASE WRITE YOUR REQUIREMENTS.

WESTON FREQUENCY METER

Model #14. 250 to 500 cycles, 100 to 125 Volts. Regular Price \$100.00.
Our Price, **\$39.95 EA.**
Brand New.....

OIL CONDENSERS

4 MFD-600VDC \$.95	6 MFD-2000VDC \$4.95
10 MFD-600VDC 1.50	10 MFD-2000VDC 6.95
2 MFD-1000VDC .95	12 MFD-2000VDC 7.95
3 MFD-1000VDC 1.25	2 MFD-2500VDC 3.95
5 MFD-1000VDC 1.95	4 MFD-2500VDC 5.95
12 MFD-1000VDC 2.95	4 MFD-2500VDC 5.95
15 MFD-1000VDC 3.50	5 MFD-4000VDC 1.50
3 MFD-1500VDC 2.85	1 MFD-4000VDC 2.75
5 MFD-1500VDC 2.85	15 MFD-5000VDC 49.50
6 MFD-1500VDC 2.95	1 MFK-700VDC 1.75
10 MFD-1500VDC 3.75	3 MFD-3000VDC 24.95
15 MFD-1500VDC 4.50	1 MFD-20KV 49.95
2 MFD-2000VDC 2.25	.00025 MFD-25KV 5.50
3 MFD-2000VDC 2.95	24 MFD-240VAC 4.95
4 MFD-2000VDC 3.95	5 MFD-660VAC 2.95
5 MFD-2000VDC 4.50	

G. E. RELAY CONTROL

(Ideal for Model Controls, Etc.)

Contains a sigma midget 8,000 ohm, relay (trips at less than 2 MA), high impedance choke, bimetal strip, neon pilot and many useful parts. The sensitive relay alone is worth much more than the total low price of... **\$1.25 Each 10 for \$9.90**

WIRE WOUND RESISTOR KITS

25 assorted 10 Watt.....	\$1.95
25 assorted 20 Watt.....	2.50
50 assorted 5, 10, and 50 Watt.....	4.95

WIRE WOUND RESISTORS

Stock too long to list. We can supply most sizes, so order what you need.

10 Watts. From 1 Ohm to 70K Ohms.....	EA. \$.15
20 Watts. From 4 Ohms to 50K Ohms.....	EA. .20
25 Watts. From 1 Ohm to 100K Ohms.....	EA. .30
50 Watts. From 5 Ohms to 100K Ohms.....	EA. .40
100 Watts. From 5 Ohms to 100K Ohms.....	EA. .50

EIMAC VACUUM CONDENSERS

12 MMF 32KVDC.....	\$10.95
50 MMF 32KVDC.....	12.95

SOLA CONSTANT VOLT TRANSFORMERS

Input 95-135 Volts
Output 115V Regulated
250 VA..... **\$33.65**

READ 'N' SAVE BARGAINS

2" NATIONAL "S" Meter, 0-1 Ma movement, calibrated in DB.....	\$2.95
Non-ind resistors, 250, 100 watt.....	.50
6 Henry 100 ma chokes.....	.85
Beinmann ckt brkr, 5.5 amp, 110 V.....	.95
Var. ceramic trimmer 7 to 45 mmf.....	.25
Eric 500 mmf ceramics.....	10 for .50
15V AC relay SPST 15 Amp contacts.....	1.75
220V AC relay SPST 15 Amp contacts.....	1.75
.01 mmf, 1000V VDC Micars.....	.95
.0004 2500 VDC Micars.....	5 for .95
.04 600 V Micars.....	5 for .45
100,000 ohm, 100 Watt resist.....	1.75
Fil. Transf. 115V, 60 cy Sec. 1.0V @ 1.5 Amp.....	1.25
Fil. Trans 115V, 60 cy Sec. 6.3V @ 7A.....	1.95

Min. Order \$3.00—25% with Order—F.O.B. New York, N. Y.

PEAK ELECTRONICS CO.

66 West Broadway, New York 7, N. Y.

Phone WOrth 2-5439

needed for testing. In fact, just a standard test pattern would provide a wealth of information; but other portions of the tape could produce patterns such as are normally obtained from a cross-hatch generator, a dot generator, or a color bar generator. Picture information could be entirely removed and just the sync signals observed. The output of the generator could be attenuated from a maximum to a strength such as would represent the weakest fringe-area reception.

"You don't think that kind of an instrument would be cheap, do you?"

"No, but I'm sure it would replace several other instruments now used whose total price would more than equal its cost. Still more important, a technician using such an instrument could determine in a few minutes more information about the condition of a receiver under test than he would be likely to learn in several hours of probing with conventional test equipment. I'm not saying we ought to have cheaper equipment. My argument is that we should have fewer and better instruments that will tell us more in less time. The way it is now, all the manufacturers seem to be trying to do is to load us down with more and more test equipment. As it is, we've had to put sideboards on our service bench to accommodate this equipment, and the end is not in sight."

"Somebody is always spoiling things," Barney complained. "I was just planning on setting up in business as a test equipment technician, and I had already worked out a fine business motto: 'Brainy Barney, the Serviceman's Serviceman.'"

W.I.M.U. HAMFEST

THE annual W.I.M.U. hamfest will be held at Big Springs, Idaho on August 6, 7, and 8 with hams from Wyoming, Idaho, Montana, and Utah attending.

Write W7NVR, Opal H. Clayton, Route 2, Idaho Falls, Idaho for full details on this affair.

TV Signal Survey

(Continued from page 43)

the signals have been found to be going directly skyward! In addition, the answers to deep slots, strong lobes, nodding effect, and many of the other problems of reception are easily ascertained.

Irregularities of terrain in particular and surrounding areas create special problems in reception, and weather also has an important effect. Moisture laden clouds tend to bend waves and cause ghosts. Distorted pictures, interference, and weak signals are often caused by such varied things as defective fluorescent lamps, power line noise, auto ignition, welding machines, and aircraft engines. The type of antenna, its height and position are of the utmost importance, depending upon location of the set. Sometimes moving an antenna only six inches on the roof gives almost 100% improvement in performance. Weeks of flying over an area, testing signal strength and patterns of TV stations—measuring radiation in both vertical and horizontal planes—produced data leading to the development of improved antennas specially designed for the area. Findings are reported in full to the TV stations, jobbers, dealers, and technicians in the territory as a preliminary to marketing the antenna.

The station is able to effectively analyze the performance of its radiating system and programs accordingly—saving the considerable time it would have taken the station to accomplish the same results. Jobbers have a certain knowledge of what to merchandise in areas surveyed, dealers can get maximum results from their efforts, and set owners are more satisfied with their TV reception—all because a couple of fellows wanted to get enough information to build a much better antenna.

A three-day color TV symposium for service technicians, held recently in Philadelphia, included a talk on color TV test equipment by J. R. Popkin-Clurman, president of Telechrome, Inc., shown below. The symposium was sponsored by the Council of Radio & Television Service Associations, a group of service associations from New Jersey, New York, and Pennsylvania, in cooperation with local parts distributors and manufacturers. The color TV lectures, coordinated by Lewis Winner, were attended by service technicians from many cities. This will be an annual CRTSA affair.

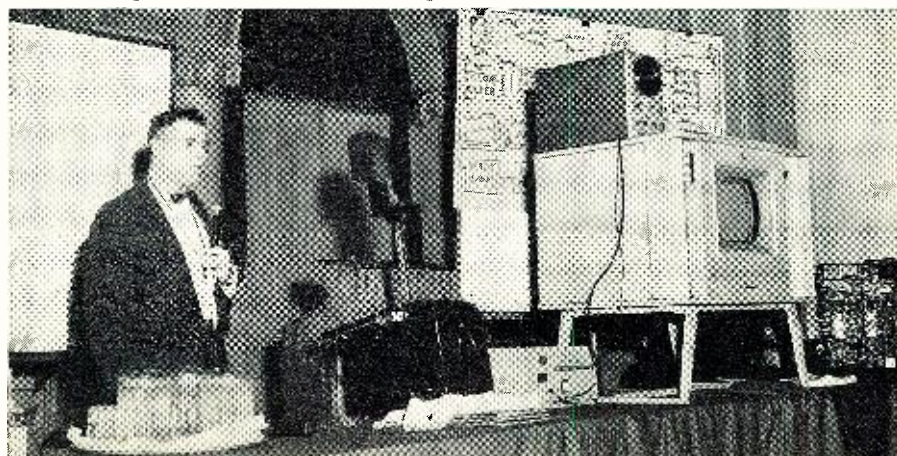

An Editorial

(Continued from page 31)

eral special tubes made their appearance and these were quickly purchased and tried out by hams in an effort to enhance the performance of their receivers. The tendency to purchase parts instead of making them at home really took hold during this year.

In 1921 amateurs, in cooperation with the Government, were giving daily market reports to farmers, newspapers, and local telephone exchanges. On April 15, 1921, the Bureau of Markets, United States Department of Agriculture, sponsored an extended system of disseminating news of marketing conditions by means of amateur radio.

On September 3, 1921, the Radio Exposition was held in Chicago. Approximately 2000 delegates attended the convention held under the auspices of the American Radio Relay League, marking the first national convention of the association. Some 300 sectional clubs affiliated with the League represented more than 6500 amateur wireless stations. Plans were perfected at the convention for trans-Atlantic wireless tests to take place in December.

In 1922 a warning was given to amateurs using wavelengths in excess of those authorized in their licenses which had resulted in much unnecessary interference. Following tentative reports of the Department of Commerce on radio telephony, waves were allocated according to class of service. The Amateur Committee accepted the recommendation that the band for amateurs be 150 to 275 meters and that the limits be fixed by law under the Department of Commerce. On December 8, 1921, the first amateur overseas transmission took place and later Dr. Lee de Forest gave his first demonstration of the "talking movie" with perfect synchronization. With or without accompanying pictures, he could photograph sounds, vocal or instrumental, on an ordinary moving picture film and from the same standard film reproduce the photographed sounds. 1922 was also the year that Edwin H. Armstrong developed the famous *Armstrong* regenerative receiver. He was also one of the designers and constructors of station 1BCG which was heard in Scotland.

This interest in radio was demonstrated by the applications for amateur transmitting stations of which there were 16,467 on September 1, 1922. On June 30, 1921, there were only 10,809 amateurs authorized to send radio communications, an increase of 5658 during that short period.

Fighting hard to demonstrate the real mettle of the radio amateur, Mr. Louis Bastain of New Orleans, Louisiana, 5HB, during the American Legion Convention, sent two complete messages to another radio amateur, 7SC, at Seattle, Washington, some 2200 miles distant. Bastain's home-made transmitting set, although rated at

July, 1954



You are FRONT ROW CENTER... with FAIRCHILD's High Compliance Diamond Cartridge

Now - you hear for yourself - new brilliance in recorded sound reproduction made possible by the Fairchild Series 215. This remarkable high-compliance cartridge brings amazing life-like quality to the most delicate nuances of recorded sound and eliminates completely listening fatigue caused by tracking distortion. *Compare.* You'll select Fairchild *professional quality*

at only \$37.50

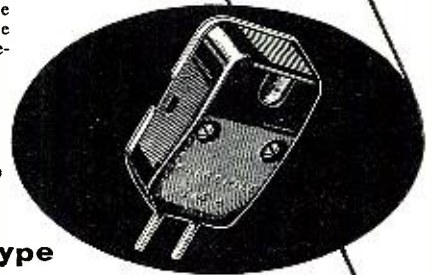

with FAIRCHILD's Plug-in Type Transcription Arm

Only by eliminating the adverse effects of arm resonance can records sound their best. Fairchild's new transcription arm allows the cartridge *alone* to lift all of the tone color from high-fidelity recordings. Dual pivoting plus a precision engineered offset provide continuous midgroove tracking. And an automatic built-in arm rest safeguards the stylus. Any standard cartridge slides into the Series 280.

Professional quality at \$29.50



with FAIRCHILD's Balanced-Bar Preamplifier-Equalizer

Imagine - tailoring your high fidelity system to your listening room characteristics. The exclusive Balanced-Bar feature makes this possible. An initial adjustment matches your speaker system to your room acoustics when the Balanced-Bar is in an unbroken horizontal position. Yet there's full *professional* flexibility of control for the unusual record. Complete record compensation and gain controls plus an exciting new listening level adaptor. Four dual-triode tubes and a built-in power supply. Just as important, decorator styling keyed to today's living.

Net to users... \$98.50



SEE YOUR AUDIO DEALER or for free folder write.

FAIRCHILD RECORDING EQUIPMENT

EIGHT AVENUE & 154th STREET, WHITESTONE, L. I., N. Y.

50% DISCOUNT on UHF Converters and ANTENNAS

Our Area is saturated with these items and we have large stocks left. Send for list of TV Bargains.

Sample Items

Regency RC600 Converter (Reg. \$49.95) \$24.97
Bow Tie Antenna & Reflector (Reg. \$3.95) \$1.75

Many Other Bargains

H & H ELECTRONIC SUPPLY, INC.
506-510 KISHWAUKEE ST.
ROCKFORD, ILLINOIS

MORE JOBS than graduates

Demand for our engineering graduates exceeds supply. *Effective placement.* Study in this world-famed college established 1884. Quarters start Sept., Jan., March, June. *Approved for Korean Vets.*

Bach. Sci. degree in 27 months

Complete Radio Eng. courses . . . TV, UHF and FM. Also Mech., Civil, Elec., Chem., Aero. and Adm. Eng.; Bus. Adm., Acct. Small classes. Well-equipped labs. Modest costs. Prep. courses. *Write Jean McCarthy, Director of Admissions for Catalog and Campus View Book.*



TRI-STATE COLLEGE

1674 College Avenue, Angola, Indiana

Trav-Electric

DC to AC

CURRENT CONVERTERS for Land... Sea... Air

JUST PLUG INTO CIGAR LIGHTER ON DASH

Change 6 or 12 Volt D. C.
to 110 Volt A. C. - 60 cycle



Operates Test Equipment,
All Electric Shavers

SIZE: 2"x2"x3½"

Trav-Electric MIDGET

Model 6-11160, 60 Cycle, 10-15 Watts

\$11.95
List



SIZE: 2½"x2½"x4½"

Trav-Electric SENIOR

Model 6-11160, 60 Cycle, 35-40 Watts

\$15.95
List

OPERATES

- Test Equipment
- Turntables
- Lights
- Short, Long Wave Radios
- Portable Phonographs
- Electric Shavers, etc.



SIZE: 4"x5"x6"

Trav-Electric MASTER

Model 6-51160, 60 Cycle, 40-50 Watts

\$24.95
List

OPERATES

- Curling Irons
- Radios
- Turntables
- Small Dictating Machines
- Test Equipment,
- Electric Shaver
- Portable Phonographs



SIZE: 4"x5"x6"

Trav-Electric SUPER

Model 6-71160, 60 Cycle, 60-75 Watts

\$37.95
List

OPERATES

- Wire Recorders
- Amplifiers
- Soldering Iron
- Radios
- Dictating Machines
- Turntables
- Small Electric Drill
- Electric Shaver

FULLY GUARANTEED
See your Jobber or Dealer

Terado COMPANY

1058 RAYMOND AVENUE
ST. PAUL 14, MINNESOTA

In Canada Write: Atlas Radio Corp., Ltd.
560 King St. West, Toronto 28, Ont.

Export Sales Division: Scheel International, Inc.
4237 N. Lincoln Ave., Chicago 18, Ill. U.S.A.

Cable Address—Harshell

only 20 watts, reached out to every state of the Union and Canada.

A new world's record was established for daylight transmission by using a Beverage antenna. This transmission took place on October 28, 1922 and spanned the distance of 2800 miles from Honolulu to Seattle. The station was operated by Thomas Marshall, 6ZY.

Amateur station licenses increased from 10,809 to 15,504 between June 30, 1921 and June 30, 1922. The total on December 1, 1922 showed 16,888. The increase in amateur interest was gratifying to the Government and it recognized the fact that these young men constituted a reserve of trained operators, some of whom had already contributed to the radio art. They had learned during World War I that many amateurs were found to be superior to the average commercial operator in resourcefulness, technical knowledge, and operating efficiency.

The ARRL, December, 1922, made plans to attempt two-way trans-Atlantic amateur radio communications. In all, 316 amateurs succeeded in spanning the Atlantic. The highest honor for amateur radio, the Hoover cup of the ARRL, was awarded in 1923 to Fred B. Ostman, 2OM. This cup, awarded annually, was given to the best all-around amateur radio station.

The year 1923 found Donald H. Mix, 1TS, chosen as wireless operator to accompany Dr. MacMillan on his famous polar expedition and to transmit from the ship "Bowdoin" a story once a week on his arctic adventure. Later the same year, Jack Barnsley, 9BP, Prince Rupert, B. C., communicated with the "S. S. Bowdoin" then in the Arctic.

In September, 1924 the Government extended radio channels for amateurs. General and restricted amateur station licenses were issued permitting the use of the wavelengths between 75 and 80 meters; 40 and 43 meters; 20 and 22 meters; and 4 to 5 meters for pure c.w. telegraphy 24 hours a day. This was great news for the ham and the field of experimenting was thrown wide open. Shortly thereafter the 13,000 miles separating London and New Zealand were bridged successfully for the first time when two British amateurs exchanged radio messages using low powered home-made apparatus. Other events of equal importance followed immediately thereafter, opening up further possibilities for the amateur.

1925 was the year when the French experimenter, Pierre LaFond, F8CN, experimented with resistance-coupled amplifiers which have now become commonplace. A combination transmitter and receiver called the "Uni-Set" was described in the March, 1925 issue of RADIO NEWS by H. M. Towne, 1ADG. The use of short waves and wire interconnection of stations was developed at a rapid pace in 1925. Short waves had finally found their place in commercial and amateur transoceanic communications and transmission of rebroadcasting, both at home and to places across the seas. The "Regenerative Neuro-

dyne" also made its appearance that year and John L. Reinartz, 1QP — 1XAM — wrote an interesting article telling how amateurs were exploring the short waves below 40 meters.

Yes, 1925 was a banner year for the ham. The Government, realizing the potential possibilities of the ham, was giving more leeway and cooperation with short-wave experiments already under way and special schedules of transmissions were formulated. Short-wave tests had proven very successful over long distances and the Government, at that time, had planned to equip Naval District Communication Centers with small high-frequency receiving sets for practical and training purposes. They had a definite interest in developing amateurs into prospective Naval Reserve radio operators.

The Signal School at Ft. Monmouth, New Jersey (1924) recommended that a system be organized so that radio amateurs of the United States could join an Army amateur radio system (AARS) and a board of officers was ordered to get together with officials of the ARRL to work out a plan of organization and operation. This was approved by the War Department on September 28, 1925 and with this official blessing the newly created AARS went to work. Some 300 amateurs were included in the initial membership but its growth thereafter was slow. Although the plan aroused much enthusiasm among radio amateurs who were willing to do their part, the lack of funds and personnel prevented the Signal Corps from giving proper attention to the organization. Soon many lost interest in the AARS and resigned. Something more timely, something more within the dream of the average amateur, was needed to make the AARS click. This vital something was introduced when a revised plan was put into effect on January 1, 1929. It emphasized as its prime objective full cooperation with the American Red Cross.

On May 17, 1926 George W. Linn, Jr., 2CJE, established radio communications between the Byrd North Pole Expedition and the Navy Department at Washington, D. C.

Down in Australia, in the year 1927, amateur radio played an important part in maintaining communications during the severe cyclone and flood which cut off all telegraph service. In this emergency the authorities fell back on the assistance of amateur radio. Licensed amateurs, working on short waves, were invaluable in maintaining communications during the disastrous New England flood of 1927. They were also contributing, during that period, to the progress of civilization by keeping exploring expeditions in touch with their home bases. In that year, Col. Clair Foster, 6HM, succeeded in working South Africa and China on the same day, thus completing his coveted record of all continents on the same tube—a common 201A and dry batteries. Contacts were made on 38.2 meters; except for communica-

tion with an English amateur on 20.2 meters.

During the period from 1927 to 1941 the ultra-high frequencies were developed largely through the efforts of the amateur. Public address systems, facsimile, amateur television, sound-on-film recording, tape recording, and many other new developments were being worked on in many a basement shop.

The late '20's and the '30's were years of continuous development and experimenting with new circuits, improved vacuum tubes, a.c. power supplies, and scanning-disc television.

When the United States entered World War II thousands of amateurs were eager to serve with the Signal Corps and other branches as radio operators, technicians, etc., and on the home front thousands more joined up with industry to produce the finest military communications equipment almost overnight.

Dr. Lee de Forest, in 1941, wrote of "Color in Television" and described the CBS tests of Peter Goldmark. The difference between the *Farnsworth* dissector tube and the RCA Iconoscope were explained. Alfred Ghirardi and John F. Rider were monthly columnists in RADIO NEWS. ASCAP and BMI were quarreling over the air. The sale of phono-radios increased tremendously. The term "high-fidelity" was used frequently by this magazine as far back as 1941. FCC stepped in to stop ham contacts with foreign stations. RADIO NEWS scooped the press with its article, "British Radio Combats Blitz."

The Japs struck at Pearl Harbor while the January, 1942 National Defense Issue was on our presses. This special and well-timed review of military communications was the forerunner of four historical "firsts" for a technical magazine. These issues became essential reference for all military communications and are still in demand. Throughout the war RADIO NEWS reported extensively on radio developments and its editors were active with the Radio Intelligence Division of FCC and the Foreign Broadcast monitoring stations—reporting techniques employed and results achieved in combating clandestine radio.

Following World War II we were privileged to witness the Atom Bomb Tests at Bikini and to publish our exclusive reports on communications at "Operation Crossroads." There follows the impact of television, microwaves, color TV, and interest in hi-fi.

When RADIO & TELEVISION NEWS made its debut in July, 1919, radio was still in its swaddling clothes of spark coils and oatmeal box receivers. To cover all of the highlights of the past 35 years is not possible in one article and we have touched only a few. The growth of our industry still continues and we welcome many new readers each month. The success of any publication is a measure of reader and advertiser loyalty. To both we say thanks—and to pledge ourselves to a continued effort on your behalf. —30—

Certified Record Revue

(Continued from page 58)

times muddy. It's easy to tell that you're in a large hall, as acoustic perspective here is almost over-reverberant. Soloists sound far away, until you hear the orchestra and then you realize the balance is correct. I heard a distinct "wow" or two in the recording. This is probably due to the curse of much European recording; electric voltage fluctuation which affects tape speed adversely. Is this "Lohengrin" worth the outlay of nearly thirty dollars? I would say yes. In spite of its faults, the virtues are many. While this version may not earn the appellation "definitive," it is close enough to it to warrant your interest. Now that there are three versions of this opera, it will likely be a long time before another edition becomes available. If you've held off buying "Lohengrin" until now, take a listen to this version. As far as I'm concerned, the combination of better over-all sound and the authenticity of the Bayreuth performance makes this the preferred recording. The recording conformed to the new RIAA curve with a slight boost in the bass and a slight cut in the treble. Surfaces were moderately quiet. An excellent English-German libretto is furnished.

TCHAIKOVSKY

THE NUTCRACKER

Minneapolis Symphony Orchestra conducted by Antal Dorati. Mercury "Olympian" OL-2-101, Old AES curve. Price \$11.90.

Before you sigh and say in disgust, "What's this, another Nutcracker Suite?," take a good look at the title in this heading. For this is *not* the Suite from the "Nutcracker," this is the first complete recording of the "Nutcracker Ballet." And what a delightful treat it is to hear. One wonders what dictated the selection of the familiar music in the Suite, and the deletion of much music that is infinitely more interesting. Taken as a whole, with all of the well known music of the Suite in its proper sequence, this is an utterly new listening experience. Why a score so rich and colorful has not been committed to LP before is a mystery. At any rate, it's ours now to enjoy and Mercury has given the project its most deluxe treatment. The album is two heavy wooden covers bound by a linen-like material in peppermint candy striping and a fancy red cord holds the illustrated pages of the "program notes" in place. On the front cover and throughout the pages which tell the story of the "Nutcracker," are some of the most charming and delightful line drawings of the various characters in the ballet. The album came "factory sealed" in cellophane, certainly a step in the right direction.

The recording itself is magnificent. Antal Dorati's conducting is obviously a labor of love and each section of the

THE American IDEA

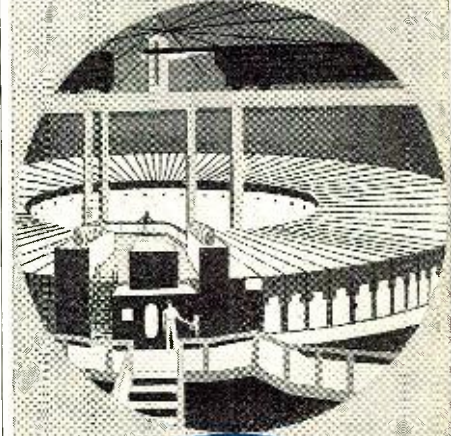

"To find and follow the better way"... Gigantic offspring of the cyclotron, the Bevatron—world's greatest magnet—can send masses of protons hurtling around its 135'-diameter race track at almost the speed of light, "Idea," to penetrate deep into the atomic nucleus, where lie secrets of matter and energy.

With us, the "American Idea" is, by directed effort and applied know-how, to continue to lead in bringing you electronic products of the highest quality.



Complete line of "Full Vision" Microphones
D33 Broadcast
D-22 Public Address

Replacement Phonograph Cartridges

INSIST ON AMERICAN FOR QUALITY
Send for FREE Catalog 47

American microphone co.

3711 South Fair Oaks Ave. • Pasadena, 1, Calif.

3 NEW RIDER BOOKS FOR JULY

1. TV FIELD SERVICE MANUAL, VOL. 2

Edited by Harold Alsberg

The finest practical data for in-the-home servicing. Tube layouts; picture tube adjustments; rear and front controls; tube complement; tuner and horizontal oscillator adjustments; key voltages; tuner dial stringing; trouble symptoms; chart with tubes and parts to check; series filament wiring. Book lies flat, spiral binding. Covers 1947 through 1953. Volume 2 covers: Bendix, Capehart, CBS Columbia, Crosley, DuMont.

Approx. 160 (5 1/2 x 8 1/2") pages, illus. Soft cover. * * * *

Volume 1 (Issued in May) Covers: Admiral, Affiliated Retailers (Artone), Aimee (AMC), Air King, Air Marshall, Allied Purchasing, Andrea, Arvin and Automatic.

128 (5 1/2 x 8 1/2") pages. Soft Cover.

Volume 1 Only \$2.10

2. HOW TO SERVICE TAPE RECORDERS

Everything you need to know about what is inside a tape recorder—operation of the recording head, types of electronic circuits, kinds of drive mechanisms used, trouble shooting—and how to service the many types of tape recorders with practical examples. Also discusses requirements for a tape recorder repair shop. Soft cover.

SPECIALIZED AUTO RADIO MANUALS

Cover 5 years production (1950 thru 1954) of factory installed car radios. Identical data from other sources is just not available! Contains: Parts List, Schematics, Tube Layout, Voltages, Trimmer Location, Chassis Views, Chassis Pictures, Dial stringing and complete installation and removal information.

3. INDEPENDENT CAR MANUFACTURERS

Covers—Kaiser-Frazer, Henry-J, Studebaker, Nash, Hudson, Packard, Willys.

VOL. 1-A (Released in May)

Ford . . . Lincoln . . . Mercury

VOL. 2-A (Release in June)

Buick . . . Cadillac . . . Oldsmobile

VOL. 3-A (Release in June)

Chevrolet, Pontiac, GMC Trucks, Chevrolet Trucks

Each Volume 8 1/2 x 11 Soft Cover

Write for complete 32-page

NEW RIDER CATALOG

Buy these books now from your jobber, bookstore—if not available from these sources, write to:

JOHN F. RIDER		PUBLISHER, INC.	
480 Canal Street, New York 13, N. Y.		480 Canal Street, New York 13, N. Y.	
in Canada, Mr. Charles W. Peacock 1826 Adelaide Street, East Toronto, Ontario	Export Agents Ruhoff Agencies, Inc. 28 Avenue Street New York 3, New York		
Head Office Office: 4218-20 W. Jefferson Blvd. Los Angeles, California	Cable Address: Riderungr N. Y.		

ballet is meticulously detailed, each musical fragment polished and burnished, until it becomes a scintillant gem of perfection. Dorati is, of course, a ballet conductor of note, and his previous recordings in this field have been well received, as have his transcription of Strauss' "Graduation Ball" and other ballet scores. In the more familiar sections of the "Nutcracker," his tempo is faster than most but seems justified in the light of the ballet taken as a whole.

Soundwise, the recording is fantastic. Certainly this score lends itself to hi-fi treatment and *Mercury's* engineers have gone whole hog on this one. Super clean, edgeless strings, bright brilliant brass, woodwinds which really soar and some incredible percussion. You'll hear thunderous tympani rolls here, and in the section which is prelude to the "Battle with the Mouse King" a combination of bass drum and cymbal clash which is positively awesome. WHAM!! If your system is a good one with a big speaker, this will rock your walls. At the start of the battle, a toy soldier calls out "Who goes there?", and fires his rifle. The score actually calls for a pistol shot here and if you are not expecting it, you'll really jump! Boy, if this doesn't test your system's transient response, nothing ever will. The battle itself is replete with tympani, triangles, cymbals and just about anything else you would care to mention. Throughout the ballet the reproduction is startling, and it's not hard to predict that this recording will find much use as a demonstration piece. I also predict *Mercury* will sell carloads of this one. It has every quality to make it a sure winner. A delightful and listenable score, fabulous sound, great conducting, smart packaging. Unreservedly recommended to you. The AES curve was adequate with controls flat. Quiet surfaces.

MONTEVERDI VESPER OF 1610

The London Singers, Ensemble Orchestral de L'Oiseau Lyre conducted by Anthony Lewis. Margaret Ritchie, soprano; Elsie Morrison, soprano; William Herbert, tenor; Richard Lewis tenor; Bruce Boyce, baritone; Geraint Jones, organist. London "Editions de L'Oiseau Lyre" OL-50021/2. RIAA curve. Price \$11.90.

Another of the initial releases in the "Editions de L'Oiseau Lyre," and one of the best musically and soundwise. I had a particular interest in this recording since I was fortunate enough to have made a binaural recording of the American premiere of the work conducted by Leopold Stokowski. Which makes for an interesting comparison.

As with most of the first releases of "L'Oiseau Lyre," the musicianship was of very high order in this recording. Of the soloists involved, Americans are most familiar with the work of Margaret Ritchie and Richard Lewis. Both are in their usual good voice here and their performances are entirely convincing. The other soloists

have less luster, but are nonetheless competent. Choral work, especially important in this piece, is very good indeed, with some of the best ensemble singing I have heard from Europe. If you are not familiar with this work and the title sounds a little formidable, don't let that scare you away. Here you will find a lovely, altogether ingratiating score, beautifully balanced between soft, tender, most lyrical passages, and rousing, exciting masses of sound as full chorus, orchestra, and organ join forces. The closing sections of the "Magnificat" are especially thrilling.

Mr. Lewis is an astute conductor and has full command of his considerable forces. Soundwise, the recording is good, but not distinguished. An occasional "fuzziness" was annoying and strings were edgy at times. Brass came through best of all and percussion, while muddy in sections, was adequate to the demands of the score. Excellent balance was maintained between orchestral and vocal elements, and spacious acoustics helped matters considerably. When you hear a work like this, and you happen to have a binaural version of the same work, the case for binaural sound is certainly valid. In the binaural recording, the choral work and the big climaxes took on a quality altogether different from the discs. In the disc, there was the almost inescapable choral "blur." On the binaural tape the chorus is completely distinct and articulate, the delineation of all elements very obvious. The directivity and depth of the binaural reproduction lends a perspective of uncanny reality. Well, who knows? It may not be too long before wonderful works like this are available in binaural editions. In the meantime, this recording is as good an exposition of this work as you're likely to get, and certainly worthy of your interest. The recording uses the new RIAA curve, but sounds better to me with a little treble cut and a little bass boost.

BRAHMS

CONCERTO #1 IN D MINOR FOR PIANO AND ORCHESTRA

Rudolph Serkin, pianist with Cleveland Orchestra conducted by George Szell. Columbia ML4829. Old NARTB curve. Price \$5.95.

Wilhelm Backhaus, pianist with The Vienna Philharmonic Orchestra conducted by Karl Bohm. London frr LL-911. RIAA curve. Price \$5.95.

What does one do about two recordings like this? In other words, when faced with such formidable talent on both discs, how do you decide who wins the potted palm? Serkin and Szell have come up with a version of this concerto that for brilliance and sheer musicianship is hard to beat. The gifted Serkin essays the work at a tempo much faster than the score would seem to indicate and receives support from Szell in this contention. Backhaus, one of the "piano giants" of our time, takes his Brahms at a more leisurely pace. His is the more

constrained, more deliberate reading and, for that matter, closer to Brahms' intentions. Bohm and the Vienna Philharmonic are in splendid rapport with Mr. Backhaus. In matter of sound, the Cleveland disc has a closer, dry type of sound and the Serkin tone is more percussive than Backhaus. The Vienna Philharmonic has a more spacious acoustic perspective and the Backhaus piano more smoothly liquid, than percussive. I think each version must stand on its own merits. If you want a reading more to the classic mold, then the *London* may be your choice. If on the other hand you want your Brahms with more dash and fire, the *Columbia* disc is for you. It's strictly a matter of taste here. Both discs conformed perfectly to their respective curves. Quiet surfaces.

BARTOK
PIANO CONCERTO #3
PROKOFIEV
PIANO CONCERTO #3

Leonard Pennario, pianist with The St. Louis Symphony Orchestra conducted by Vladimir Golschmann. Capitol FDS, P8253. RIAA curve. Price \$5.95.

This arrived too late to compare with the *London* disc of these works last month. Pennario is a young pianist with a terrific technique. His performance is the most dazzling yet recorded. While his tempo may be regarded by some as too fast, it lends a certain life, a spontaneity to these works, in keeping with their musical content. I still think Mr. Katchen on the *London* disc is the more polished performer, but there is much to be said for Pennario's exuberance. Soundwise, it's a toss-up. The Bartok is better sounding here than on the *London* disc and the Prokofiev sounds better on the *London* than on this *Capitol* disc. Both are very close to each other. Piano tone is more percussive in this version than the *London*, recording generally is "close-up" with good string tone, excellent brass and percussion. Mr. Golschmann lends sympathetic support to Mr. Pennario, and the orchestra sounds much better in this disc than in its previous efforts for *Capitol*. The RIAA curve (Continued on page 110)

NEW SUPER POST TOWERS FOR TELEVISION ANTENNAS IN FRINGE AREAS

TOWERS OF STRENGTH TO LAST A LIFETIME

Self-supporting tower built up of galvanized steel sections. No guy wires necessary. Easy to erect. Safe and resistant to high wind. Available in heights 33 ft., 47 ft., 60 ft., 73 ft., 87 ft., and 100 ft., with bases in proportion.

FRINGE AREA TV BUYERS MUST HAVE SPECIALLY BUILT TOWERS FOR CLEAR RECEPTION

Tower and the TV set go hand in hand as a package sale to rural TV buyers. Provides an extra sale and profit to dealers. An excellent fast selling accessory for jobbers and dealers.

TERRITORIES OPEN FOR JOBBER DEALER FRANCHISE

Write for complete structural details, packing, prices, discounts, and territorial assignment.

Available in Heights from 33 ft. to 100 ft.

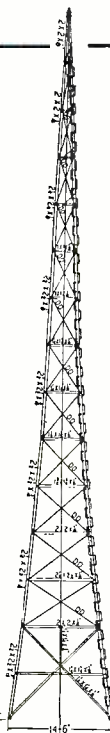
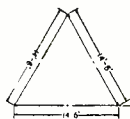

MANUFACTURED BY

AERMOTOR CO.

Dept. 6107, 2500 Roosevelt Road, Chicago 8, Illinois
BUILDERS OF STEEL TOWERS SINCE 1888

Windsor

RADIO & TV RECEIVING

TUBES

GUARANTEED ONE FULL YEAR

... FOR PEAK PERFORMANCE!

Type	Each	Type	Each
0A2	\$.90	1N4	.75
0B2	.88	1R4	.85
0C3	.95	1R5	.62
1A7GT	.67	1S4	.67
1A4	.90	1S5	.57
1B3GT	.89	1T4	.52
1H5GT	.51	1U4	.61
1J6	.93	1U5	.51
1L4	.63	1V2	.45
1L6	.66	1X2A	.74
1L4A	.82	2X2	1.43
1L6A	.80	3A5	.90
1L8A	.82	3LF4	.76
1LC5	.80	3Q4	.66
1LC6	.80	3Q5GT	.72
1LD5	.80	3S4	.61
1LE3	.80	3V4	.62
1LH4	.80	5R4GY	1.00
1LN5	.80	5U4G	.44
1N34	.90	5Y3G	.37
1N5GT	.63	5Y3GT	.32
1N48	.50	5Y4G	.43

Thousands of Service Organizations and Dealers send us REPEAT orders month after month—they KNOW you can DEPEND on the WINDSOR promise of PEAK PERFORMANCE! Every tube we ship is first carefully tested in our labs, right in a radio or TV set, under actual operating conditions. Each WINDSOR tube is attractively packaged in the famous WINDSOR carton that has gained consumer acceptance throughout America.

BUY—and SELL—WINDSOR TUBES, with CONFIDENCE!

Type	Each	Type	Each	Type	Each	Type	Each	Type	Each	Type	Each
6A8GT	.98	6BE5	.96	6Q7GT	.55	7A5	.70	7B7	.70	7C4	.70
6AB4	.51	6BF5	.86	6R7	.75	7A6	.57	7S7	.90	7D7	.92
6AC5GT	.82	6BF6	.43	6S4	.51	7A7	.58	7V7	.92	7E7	.92
6AC7	.90	6BG6G	1.47	6S8GT	.75	7A8	.56	7W7	.99	7F7	.99
6AF4	1.10	6BH6	.63	6SA7GT	.57	7AD7	1.05	7X6	.62	7Y4	.62
6AG5	.59	6BJ6	.53	6SC7	.63	7AF7	.63	7Y4	.45	4J7	.85
6AH4	.58	6BK5	.76	6SD7	.55	7AG7	.65	7Z4	.50	4N7	.75
6AK5	.89	6BK7	.97	6SE5GT	.66	7AH7	.65	12A6	.60	4Q7	.62
6AL5	1.05	6B7GT	.94	6S7	.55	7AJ7	.70	12A5	.44	4R7	.85
6AN8	.44	6BN6	.98	6SH7GT	.52	7B4	.54	12AT6	.53	4S7	.80
6AN8	.95	6BQ6GT	.98	6SJ7GT	.52	7B5	.51	12AT7	.75	19B6G	1.53
6AQ5	.51	6BQ7	.92	6SK7GT	.55	7B6	.52	12AU6	.47	19T8	.87
6AQ6	.47	6BY5G	.85	6SL7GT	.68	7B7	.58	12AU7	.58	25A5	.85
6AQ7	.75	6BZ7	1.09	6SN7GT	.59	7C4	1.05	12AV6	.41	25B6GT	.95
6AR5	.42	6C4	.41	6SO7GT	.66	7C7	.58	12AV7	.87	25L6GT	.53
6AS5	.55	6C5GT	.60	6T8	.85	7C6	.50	12AX4	.72	11Z73	.43
6AS7G	4.50	6CB6	.58	6U4GT	.60	7C7	.58	12AX7	.67	11Z6GT	.75
6AT6	.42	6CD6G	2.04	6U5	.72	7E5	.85	12AY7	2.15		
6AU5GT	.85	6D6	.63	6U8	.86	7E6	.65	12B4	.66		
6AU6	.47	6E5	.72	6V3	1.09	7E7	.85	12BA6	.50		
6AV5	.85	6F5GT	.54	6V6GT	.51	7F7	.69	12BA7	.66		
6AV8	.41	6H6GT	.55	6W4GT	.50	7F8	.97	12BD6	.51		
6AX4	.72	6J5GT	.44	6W6GT	.63	7G7	.85	12BE6	.52		
6B8G	.93	6J6	.68	6X4	.37	7H7	.61	12BH7	.69		
6BA6	.50	6J7	.70	6X8	.82	7J7	.85	12BY7	.77		
6BA7	.66	6K6GT	.45	6X5GT	.36	7K7	.85	12J5GT	.48		
6BC5	.58	6K7	.70	6Y6G	.64	7L7	.85	12SA7G	.57		
6BD5GT	.98	6L6G	.88	6Z5	.60	7M7	.62	12SH7GT	.67		
6BD6	.54	6L6GA	.88	7A/XXL	.57	7Q7	.62	12SK7GT	.55		

WINDSOR "WONDER-BEAM" 3-WAY TV ANTENNA



For Average Areas, Fringe Areas, and UHF. Adjustable arms, and new electronic wonder-switch for optimum performance with any TV set!

SPECIAL PRICE, Lots of Six, Each \$5.69
Singly, Each \$5.95

FREE! WINDSOR TUBE CADDY

Most practical service-aid ever designed for Radio & TV repairmen. Now offered FREE with every purchase of \$160.00 or accumulated purchases totalling \$160.00 within 90 days. (You get Caddy credit memo with each purchase.)

- Carries approximately 125 tubes including meters and tools.
- 16 3/4" Long, 8 1/4" Wide, 13 3/4" High. Weighs only 9 lbs.
- Ruggedly constructed with heavy leatherette covering, strong plastic handle, nickel plated hardware, and reinforced with metal clamps.

WINDSOR TUBE CADDY MAY ALSO BE PURCHASED \$14.95 OUTRIGHT FOR

Note to our Latin-American Friends: "Se Habla Espanol."



WINDSOR "BROW-LITE"



Leave Both Hands Free To Work!

World's most useful flashlight! Ideal for Radio & TV Repairmen. Uses standard penlite batteries and bulb. Won't interfere with glasses, rides above them over the brow. Complete with Batteries

\$4.95

WINDSOR ELECTRONIC TOOL CO.
2612-N NOSTRAND AVENUE, BROOKLYN 10, N. Y.

Communication Engineers

with
experience in
the fields of

**Systems
Engineering
Information
Theory
Circuit
Development
Electro-
mechanical
Development
Equipment
Engineering**

THE OPENINGS

Advancements in the fields of wave propagation, translation of information, communication theory, circuit techniques and equipment miniaturization have created a number of new openings for qualified engineers in the Hughes Advanced Electronics Laboratory.

AREAS OF WORK

The communication group is concerned with the design and development of unique radio communication systems and with exploiting new radio communication techniques. Specialists in propagation phenomena, antenna systems, network theory, magnetic recording, wide-band amplification, and intricate electromechanical devices are active in this program.

Assurance is required that relocation of applicant will not cause disruption of an urgent military project.

Hughes

**RESEARCH AND
DEVELOPMENT
LABORATORIES**

Scientific
and Engineering
Staff

CULVER CITY,
LOS ANGELES
COUNTY,
CALIFORNIA

was adequate with controls set flat. Surfaces not as quiet as is usual with Capitol discs.

MOZART

**SYMPHONY #41 (JUPITER)
SYMPHONY #35 (HAFFNER)**
Pittsburgh Symphony Orchestra conducted by William Steinberg. Capitol FDS, P8242. RIAA curve. Price \$5.95.

Both of these works have been recorded many times previously, but never in this particular coupling. Mr. Steinberg has chosen a rather slow tempo for the "Jupiter," which however, he uses to good advantage in creating some splendid sonorities with the ever-improving Pittsburgh Symphony. His deliberateness is fortunately never heavy-handed which saves this particular performance from the downright "stodginess" typical of this treatment with other conductors. Steinberg's reading of the "Haffner" is something else again. Here is all glitter and brilliance. This is the light-hearted Mozart at his sparkling best. As to preferences, I still like Sir Thomas Beecham's version of the "Jupiter," but in the "Haffner," Steinberg takes his hat off to no one.

From the sound standpoint, both symphonies receive the best recording yet afforded them. String tone is very clean, woodwinds are exceptionally bright. All other elements are sharply in focus. Good spacious acoustics help to maintain the illusion of liveness. A little treble roll-off helped the RIAA curve to my ear.

RUSSIAN PROGRAM

Philadelphia Orchestra conducted by Eugene Ormandy. Columbia ML4856. Old NARTB curve. Price \$5.95.

An attractive potpourri of works by Rimsky-Korsakov and Tchaikovsky. While all of them have been recorded before, none (with the exception of the "Capriccio Espagnol") has ever been afforded such a virtuoso performance and such excellent sound. More or less frankly intended as display pieces for the Philadelphia Orchestra, the results are magnificent. The Philadelphia is truly an incredible instrument. The luster of its strings, the brilliance of the first desk men, is a revelation to the ear. Of the Rimsky-Korsakov works, the "Dance of the Tumblers" is the most effective and exciting. The well known "Flight of the Bumble Bee" is taken in stride by the orchestra and the "Capriccio Espagnol" is well performed, although I still prefer the sound of the Paray-Detroit Symphony version on *Mercury*. In the "Capriccio Italien" of Tchaikovsky, the orchestra turns in a stunning reading under the baton of the perceptive Mr. Ormandy and even out-guns the reading of the redoubtable Sir Thomas Beecham. Plenty of fire and fury here. The "Andante Cantabile" from Tchaikovsky's "Quartet #1" is a pleasant little interlude from the Bing and Bang of the other works on the disc. Throughout, the recording is very clean and well balanced. Notable percussion and brass sounds. A

premier disc from all aspects. NARTB curve was just right with controls set flat. Quiet surfaces in my copy.

SCARLATTI

THE PASSION ACCORDING TO ST. JOHN

Choir of St. Thomas' Episcopal Church, New Haven, Conn., members of Yale University Orchestra conducted by Howard Boatwright. Blake Stern—Evangelist; David Laurant—Jesus; James Borden—Pilate; G. George—organist. Overtone LP1. Old NARTB curve. Price \$5.95.

Another worthy effort from that venturesome small company, *Overtone* records. This is not only a first performance on LP it is, as far as anybody knows, the first performance since the days of Scarlatti! The reason for its neglect is preoccupation with the "Passions" of Bach and Schutz, although that can't be the entire story. Certainly it should not have been neglected from a musical standpoint, for this is a remarkable documentation of Christ's Passion. In contradistinction to the "Passions" of other composers, Scarlatti used the complete text of the Passion. This is unusual, as is his use of the orchestra in a work that is purely liturgical. Whatever his reasons, the result is to our musical enrichment. Blake Stern, who has been heard in the "St. John Passion" of Bach on the *Victor* label, is as effective and telling here as he was in that performance. His traversal of difficult phrasings and intonations is a miracle of fluency. The other soloists are excellent singers and carry off their roles with ease. The Choir was evidently thoroughly trained for this event and it has a solid, satisfying sound.

The reproduction of a work as complex as this is always a problem, which has been met successfully on this disc. There is a minimum of choral "blasting" or blur, and the whole is cleanly articulate. If you are a lover of the baroque in music, you'll like this splendid work. I liked a little bass boost in conjunction with the NARTB curve. Good surfaces.

McDONALD (HARL)

SUITE FROM CHILDHOOD

CAPLET

THE MASK OF THE RED DEATH
Ann Mason Stockton, harpist with The Concert Arts Orchestra conducted by Felix Slatkin. Capitol FDS, P8255. RIAA curve. Price \$5.95.

Two attractive "first time on LP" selections make up the music on this disc. "The Mask of the Red Death" is a modern work scored for string orchestra and harp. It is as eerie as its name, being frankly programmatic. The story is taken from the work by Edgar Allen Poe, and it certainly is a grisly tale. The harp plays a very important role in this work, being used in abstract form and descriptively as well. The harp realistically tells the midnight hour like an old clock, and the string orchestra uses all sorts of devices like harmonics and mutes, and odd bowing techniques to convey

the eerie terror of the work. In this composition you will hear some wonderful string playing and some of the best reproduction of strings on record.

The "Suite From Childhood" is a very engaging work with fragments of nursery tunes running all through it. The composer engages in clever transposition of these nursery themes, but they are not grotesquely distorted and the themes are easily recognizable. The harp is again of major import in this work and is used most effectively. The work is, in general, very colorful and gay, and while "modern" in structure, is easy to assimilate. Miss Mason is a superb harpist and in this recording you will hear some really outstanding reproduction of the harp. The over-all level of sound quality is the best to come from Capitol thus far. The RIAA curve was adequate, with controls set flat, and surfaces were quiet.

MOZART

CONCERTO #23 FOR PIANO AND ORCHESTRA
CONCERTO #24 FOR PIANO AND ORCHESTRA

Clifford Curzon, pianist with The London Symphony Orchestra conducted by Josef Krips. London firr LL-918. RIAA curve. Price \$5.95.

Among the most popular of Mozart's piano concerti are the two recorded on this London disc. Their popularity is well deserved as they are certainly among the most "tuneful" music Mozart ever wrote. As with nearly all the standard repertoire on LP, these concerti have been recorded many times before. So, we come to the old question; is this new version superior to what has appeared previously? The answer is a decided "yes." There may be those who prefer the old Lili Krauss recordings, or those of Schnabel. I'll admit they were my favorites up to now. Curzon is one of today's better pianists and it would be a real crank who could find major faults with his reading of these concerti. Dynamics, phrasing, articulation, he is masterful in all of these. His tempi come closer to Krauss' than anybody else's reading, and Madame Krauss was always known to hew the straight and narrow in matter of tempo. A master craftsman, Curzon handles the concerti with a light touch throughout and brings a sort of liquid grace to these lovely works. Krips is an old hand with Mozart and his accompaniment is complementary to Mr. Curzon. A good balance between piano and orchestra is maintained.

The sound is by far the best on records, with bright, clean-toned piano, and smooth strings. About the only thing I could quibble with is that the action of the piano, the thumping of the hammers, could be heard at times. This is most unusual for London, as they are usually very careful about such things. The RIAA curve needed an assist in the bass end to sound right to my ears. Surface slightly ticky.



TERRIFIC TUBE VALUES!

TOP QUALITY FULLY GUARANTEED TUBES BELOW MFRS' PRICES

THIS MONTH'S SPECIALS

Our new policy brings you greater tube savings than you thought possible! As a GOODWILL offering, we are giving, each month, a number of popular tube types (listed below in extra bold) at PRICES BELOW OUR OWN types each month, in industry-wide publications!

We specialize in TUBES—Receiving, transmitting and special purpose, etc.—serving the industry for years. More than 3000 different types in stock for IMMEDIATE DELIVERY—including hard-to-get and discontinued numbers. All tubes exhaustively tested in our fully equipped laboratories, and re-tested at time of shipment. FULL ONE-YEAR GUARANTEE. All tubes individually boxed and code-dated.

Type	Price	Type	Price	Type	Price	Type	Price	Type	Price
OAA3/VR75	.99	3D6	.39	6D8G	.98	7A6	.89	12A7	.63
OAA4	.65	3LF4	.79	6F6	.45	7AD7	.95	12C8	.34
OAA5	.74	30A4	.52	6F7	.69	7A7	.89	12F5GT	.35
OBB3/VR90	.95	35GT	.53	6F8G	.69	7B7	.89	12H6	.27
OCC3/VR105	.98	35A	.50	6GG6	.65	7AH7	.56	12J7	.39
OD3/VR150	.89	3V4	.52	6H6	.49	7B4	.44	12K7	.55
024	.54	5U4G	.53	6J5	.42	7C4	.58	12L7GT	.58
1A5GT	.43	5Y3GT	.38	6J6	.49	7C5	.49	12M7	.55
1A85	.39	5Z3	.33	6K7	.39	7C7	.69	12N7GT	.61
1AX2	.55	6A5	.47	6K8G	.65	7E7	.65	12P7GT	.69
1B3	.69	6A8	.69	6L7G	.39	7F7	.59	12S7GT	.69
1D8GT	.77	6AB4	.49	6N7	.98	7H7	.69	12T7GT	.69
1G6GT	.54	6AB7	.75	6P7	.49	7L7	.59	12U7GT	.69
1H5GT	.48	6AC5GT	.79	6Q7	.75	7M7	.62	12V7GT	.69
1J6G	.59	6AC7	.69	6R7	.42	7N7	.62	12W7GT	.69
1L4	.45	6AF4	.89	6S4	.42	7P7	.61	12X7GT	.69
1L44	.59	6AF6	.75	6S7	.59	7Q7	.61	12Y7GT	.69
1LA6	.79	6AG5	.52	6S7GT	.38	7R7	.65	12Z7GT	.69
1LB4	.79	6AG6	.52	6S8	.45	7S7	.65	12AK7GT	.69
1LE3	.78	6AH5	.89	6S8GT	.43	7T7	.65	12AL7GT	.69
1LC6	.79	6AH6	.89	6S9	.45	7U7	.65	12AM7GT	.69
1LD5	.52	6AJ5	.89	6SF7	.59	7V7	.65	12AN7GT	.69
1LE3	.78	6AK5	.49	6SG7GT	.40	7W7	.65	12AO7GT	.69
1LG5	.77	6AL5	.39	6SH7	.60	7X7	.65	12AP7GT	.69
1LH4	.78	6AQ5	.41	6SH7GT	.50	7Y7	.65	12AQ7GT	.69
1LNS	.57	6AT6	.37	6SJT	.39	7Z7	.65	12AR7GT	.69
1P5GT	.56	6AU6	.43	6SJT	.39	10Y	.69	12AS7GT	.69
1Q5GT	.57	6AV5	.39	6S7GT	.52	12A6	.69	12AT7GT	.69
1R5	.49	6AV6	.37	6S8GT	.52	12A6	.69	12AU7GT	.69
1S4	.58	6AX4GT	.57	6S8	.45	12A7	.69	12AV7GT	.69
1S5	.43	6B7	.95	6S8GT	.43	12A7	.69	12AW7GT	.69
1SA6	.48	6B8G	.29	6S9	.45	12A7	.69	12AX7GT	.69
1T4	.48	6BA9	.42	6S9GT	.43	12A7	.69	12AY7GT	.69
1U4	.49	6BB6	.52	6S9	.45	12A7	.69	12AZ7GT	.69
1U5	.48	6BD6	.49	6S9GT	.43	12A7	.69	12BA7GT	.69
1X2A	.55	6BE6	.39	6S9	.45	12A7	.69	12BB7GT	.69
2A3	.99	6BG6	1.24	6S9GT	.43	12A7	.69	12BC7GT	.69
2A6	.64	6BH6	.48	6S9	.45	12A7	.69	12BD7GT	.69
2A7	.64	6BK7	.95	6S9	.45	12A7	.69	12BE7GT	.69
2B7	.64	6BL7	.95	6S9	.45	12A7	.69	12BF7GT	.69
2X2	.64	6BM7	.95	6S9	.45	12A7	.69	12BG7GT	.69
2X2A	1.15	6BN7	.95	6S9	.45	12A7	.69	12BH7GT	.69
3A4	.44	6BQ6	.72	6S9	.45	12A7	.69	12BI7GT	.69
3A5	.44	6BQ7A	.59	6S9	.45	12A7	.69	12BJ7GT	.69
3A8	.60	6C7	.89	6S9	.45	12A7	.69	12BK7GT	.69
3B7	.39	6C8	.39	6S9	.45	12A7	.69	12BL7GT	.69
		6C8G	.85	6S9	.45	12A7	.69	12BM7GT	.69
		6C8G	.85	6S9	.45	12A7	.69	12BN7GT	.69
		6C8G	.85	6S9	.45	12A7	.69	12BO7GT	.69
		6C8G	.85	6S9	.45	12A7	.69	12BP7GT	.69
		6C8G	.85	6S9	.45	12A7	.69	12BQ7GT	.69
		6C8G	.85	6S9	.45	12A7	.69	12BR7GT	.69
		6C8G	.85	6S9	.45	12A7	.69	12BS7GT	.69
		6C8G	.85	6S9	.45	12A7	.69	12BT7GT	.69
		6C8G	.85	6S9	.45	12A7	.69	12BU7GT	.69
		6C8G	.85	6S9	.45	12A7	.69	12BV7GT	.69
		6C8G	.85	6S9	.45	12A7	.69	12BW7GT	.69
		6C8G	.85	6S9	.45	12A7	.69	12BX7GT	.69
		6C8G	.85	6S9	.45	12A7	.69	12BY7GT	.69
		6C8G	.85	6S9	.45	12A7	.69	12BZ7GT	.69
		6C8G	.85	6S9	.45	12A7	.69	12CA7GT	.69
		6C8G	.85	6S9	.45	12A7	.69	12CB7GT	.69
		6C8G	.85	6S9	.45	12A7	.69	12CC7GT	.69
		6C8G	.85	6S9	.45	12A7	.69	12CD7GT	.69
		6C8G	.85	6S9	.45	12A7	.69	12CE7GT	.69
		6C8G	.85	6S9	.45	12A7	.69	12CF7GT	.69
		6C8G	.85	6S9	.45	12A7	.69	12CG7GT	.69
		6C8G	.85	6S9	.45	12A7	.69	12CH7GT	.69
		6C8G	.85	6S9	.45	12A7	.69	12CI7GT	.69
		6C8G	.85	6S9	.45	12A7	.69	12CJ7GT	.69
		6C8G	.85	6S9	.45	12A7	.69	12CK7GT	.69
		6C8G	.85	6S9	.45	12A7	.69	12CL7GT	.69
		6C8G	.85	6S9	.45	12A7	.69	12CM7GT	.69
		6C8G	.85	6S9	.45	12A7	.69	12CN7GT	.69
		6C8G	.85	6S9	.45	12A7	.69	12CO7GT	.69
		6C8G	.85	6S9	.45	12A7	.69	12CP7GT	.69
		6C8G	.85	6S9	.45	12A7	.69	12CQ7GT	.69
		6C8G	.85	6S9	.45	12A7	.69	12CR7GT	.69
		6C8G	.85	6S9	.45	12A7	.69	12CS7GT	.69
		6C8G	.85	6S9	.45	12A7	.69	12CT7GT	.69
		6C8G	.85	6S9	.45	12A7	.69	12CU7GT	.69
		6C8G	.85	6S9	.45	12A7	.69	12CV7GT	.69
		6C8G	.85	6S9	.45	12A7	.69	12CW7GT	.69
		6C8G	.85	6S9	.45	12A7	.69	12CX7GT	.69
		6C8G	.85	6S9	.45	12A7	.69	12CY7GT	.69
		6C8G	.85	6S9	.45	12A7	.69	12CZ7GT	.69
		6C8G	.85	6S9	.45	12A7	.69	12DA7GT	.69
		6C8G	.85	6S9	.45	12A7	.69	12DB7GT	.69
		6C8G	.85	6S9	.45	12A7	.69	12DC7GT	.69
		6C8G	.85	6S9	.45	12A7	.69	12DD7GT	.69
		6C8G	.85	6S9	.45	12A7	.69	12DE7GT	.69
		6C8G	.85	6S9	.45	12A7	.69	12DF7GT	.69
		6C8G	.85	6S9	.45	12A7	.69	12DG7GT	.69
		6C8G	.85	6S9	.45	12A7	.69	12DH7GT	.69
		6C8G	.85	6S9	.45	12A7	.69	12DI7GT	.69
		6C8G	.85	6S9	.45	12A7	.69	12DJ7GT	.69
		6C8G	.85	6S9	.45	12A7	.69	12DK7GT	.69
		6C8G	.85	6S9	.45	12A7	.69	12DL7GT	.69
		6C8G	.85	6S9	.45	12A7	.69	12DM7GT	.69
		6C8G	.85	6S9	.45	12A7	.69	12DN7GT	.69
		6C8G	.85	6S9	.45	12A7	.69	12DO7GT	.69
		6C8G	.85	6S9	.45	12A7	.69	12DP7GT	.69
		6C8G	.85	6S9	.45	12A7	.69	12DQ7GT	.69
		6C8G	.85	6S9	.45	12A7	.69	12DR7GT	.69
		6C8G	.85	6S9	.45	12A7	.69	12DS7GT	.69
		6C8G	.85	6S9	.45	12A7	.69	12DT7GT	.69
		6C8G	.85	6S9	.45	12A7	.69	12DU7GT	.69
		6C8G	.85	6S9	.45	12A7	.69	12DV7GT	.69
		6C8G	.85	6S9	.45	12A7	.69	12DW7GT	.69
		6C8G	.85	6S9	.45	12A7	.69	12DX7GT	.69
		6C8G	.85	6S9	.45	12A7	.69	12DY7GT	.69
		6C8G	.85	6S9	.45	12A7	.69	12DZ7GT	.69
		6C8G	.85	6S9	.45	12A7	.69	12EA7GT	.69
		6C8G	.85	6S9	.45	12A7	.69	12EB7GT	.69
		6C8G	.85	6S9	.45	12A7	.69	12EC7GT	.69
		6C8G	.85	6S9	.45	12A7	.69	12ED7GT	.69
		6C8G	.85	6S9	.45	12A7	.69	12EE7GT	.69
		6C8G	.85	6S9	.45	12A7	.69	12EF7GT	.69
		6C8G	.85	6S9	.45	12A7	.69	12EG7GT	.69
		6C8G	.85	6S9</					

**MODEL 27-Z
TESTER**

(Made in Japan)

\$10.95

(Plus 25¢ shipping)

RANGES: AC and DC volts 0-5, 25/250/500, DC MA 0-1/10/100/250 Ohms 0-10K, 100K. Black bakelite panel, metal case. Manufacturer's claims extreme accuracy and our spot checks show them to be within 1%!



MN-26C RADIO COMPASS. Remote controlled. Freq. range: 150-1500 KC. 24 V. in. Easy to convert to 12 V. P.E. for marine, aircraft, etc. Receiver & loop BRAND NEW, other accessories slightly used. **COMPLETE INSTALLATION PLUS SCHEMATIC \$69.50**

HEAVY DUTY ALNICO-5 MAGNETRON MAGNET. 7 1/2 lb. Ea. Will hit 50 lbs. \$7.49
BABY WINCH. Reversible. 24 V. AC or DC. Bike sprocket or cable drum take-off. For beam, garage door opener, Bar-B-Que, boat rudder control, etc. **NEW WITH INSTRUCTIONS \$4.95**

RADIO CONTROL

Build receiver from schematic we furnish with our 5 high-peaked, extremely selective AF band-pass filters. Kill interference from other transmissions. Get 5 operations at one R.F. From Air Forces radio-controlled target plane receiver. Passes through 1000 cps. are: 300, 650, 950, 1350 and 3,000 cps. **\$2.95**
All five with schematic. Only

CAN CONTAINING 4 CLARE TYPE K MINIATURE RELAYS \$2.95

HEY, LO-O-O-K! TURN A KNOB on the shaft of a special motor-like device and one or more of the same units (as far away as you have radio contact with them) will turn to EXACTLY THE SAME ANGULAR POSITION as the knob! Powerful enough to operate valves, open doors, turn antennas, etc. These high-torque 115 V. 60-cycle selsyns normally sell for \$27.50 EACH. But we made a lucky buy! **WITH INSTRUCTIONS, PER PAIR ONLY \$17.95**
Each Additional Unit \$7.95

FILTER-CAPACITOR STEALS!

- 1) 1 mfd. 600 VDC, oil, hermetically sealed Ea. 15¢. \$1.49
- 2) 8 mfd. @ 600 VDC, oil filled. \$9.00
- Ea. 98¢, 10 for \$9.00

\$45.00 HI-FI HEADSET AT \$7.95

Uses annular grooved plastic fibre cones with voice coils as in speakers, and padded chamois ear muffs to obtain spacing for correct acoustical load. Gives finest music reproduction, 600 ohms. Checked out with freshly laundered ear pads and long flexible fabric cord with phone tips. (Shpg. wt. 3 lbs.). **\$7.95**

**24-HOUR TIME CLOCK SWITCH
90% DISCOUNT!**

HEAVY DUTY SANGAMO MECHANISM: 115 or 230 V. 60 cycles. Up to 3 "ON"s and "OFF"s. Skip "OFF"s any one or two days you wish. 30A DPST Switch. Controls lawn sprinklers, neon signs, hen-house lights, etc. With instructions. (Dealers: Write for quantity discounts.) **\$4.95**
HALF-INCH PIPE SIZE SOLENOID VALVE. 18 to 24 VDC. 1/2 A. Controls lawn sprinkler mechanism. \$2.95
TRANSFORMER. 115 V. 60 cycles to 24 V. .6A. for above solenoid & many other uses. 98¢.
SELENIUM RECTIFIER. 300 CY. rms. 34A. full wave. For above transformer & solenoid. . . \$1.50

12 V. RECEIVER DYNAMOTOR

Same as the 12V dynamotors on the back end of your 274-N or ARC-5 command receivers, except that these are made for 9 to 14 volts. Same base plate and plug connections. Output 250V, 60 ma. **\$4.95**
DY-1/ARR-2X, like new, checked out.

GENERATOR-ALTERNATOR SPECIAL

120V AC PLUS 28.5V DC
Two units in one package, each complete in itself: the removable centrifugal slip clutch and the generator-alternator. Clutch maintains armature speed of 2400 rpm for drive speeds varying between 600 and 4200 rpm. Output 120V, 800 CY. rms. 1080 VA plus 28.5 v, 25 A DC. Drive it from engine or electric motor. With diagram and instructions. **\$9.95**
Excellent condition.
VOLTAGE REGULATOR (carbon pile) for above. **\$2.95**
New

200 AMP 24 V. GENERATOR

For marine-aircraft-farm-amateur-summer home-battery charging-welding-etc. Heavy Duty 24-30 VDC. 4400-8000 RPM. G.E. type 2CM-81B2 (Air Forces P1) Excellent condition. A \$47.50 **\$9.95**
value for only

12 V. DYNAMOTOR



(D. W. Thomas Engineering, Inc.)
NEW! Guaranteed. Ready to use. Continuous duty ratings. Gray finish. 10" lg. You connect for either 10" lg. 400 V @ 350 ma. or 600 V @ 200 ma. With inst. **\$9.95**
(Less base.)
Add \$6.00 for base box containing starting relays & filters as shown. Shipping wt., 11 lbs.; with base, 13 lbs.

METERS, 2" rd.; 0-1 ma \$3.95. 500-0-500ma \$3.95

G. L. ELECTRONICS, INC.

905 S. Vermont Ave., Los Angeles 6, Calif.
Minimum Order \$5.00 Total, 25% Deposit Required
All Prices F.O.B. Los Angeles, Calif. Buyers Add Sales Tax
GET ON OUR MAILING LIST

**SCHEMATICS—CONVERSIONS
FOR SURPLUS GEAR**

NEW LIST! MANY ADDITIONS!

Send stamped, self addressed envelope for List C. Add 25¢ for chart explaining AN nomenclature.

R. E. BOX 1220
GOODHEART BEVERLY HILLS, CAL.

RADIO-TV Service Industry News

**AS REPORTED BY THE
TELEVISION TECHNICIANS LECTURE BUREAU**

AS WE MOVE into the normal lull in the electronics servicing business during the summer months, it seems quite evident that the months ahead will witness the largest mortality rate in service businesses the industry has experienced to date. A combination of factors that included the light Winter and early Spring, the leveling off of industrial activity and the tremendous interest in do-it-yourself programs brought about an earlier-than-usual decline in consumer interest in service. And, oddly enough, a large number of men chose this particular period to launch new service businesses!

Three or four years ago the heaviest mortality in the business of television servicing was among the larger shops. This was brought about by over-expansion, failure to conserve contract income to carry the businesses through light months, and general mismanagement. The large organizations that managed to weather this period of business attrition were given a breathing spell of good business during the last Presidential campaign and they were able to adjust the operating patterns of their organizations to the "hill and valley" characteristics of television servicing.

Most of the multi-manned organizations have added air conditioner installation and service (which reaches its peak during the season when TV service volume is at its lowest point); major appliance servicing; traffic appliance servicing; auto radio servicing; and 2-way communications systems maintenance to level off their service volume.

An important thing the large service organizations learned the hard way was that service must be sold. They found out that it was impossible to maintain an adequate, dependable volume of business without a consistent, professionally-prepared service sales promotional program. So in those organizations, business promotion is of equal importance to technical competence. You can't cash in on the latter unless you are able to sell it profitably.

So now it's the one-man shop that gets hurt the most when the volume of service business drops off. Since he seldom is able to build an adequate cash

reserve when business is good and time doesn't allow him to accomplish the flexibility that is possible in multi-manned organizations, he is apt to get into serious financial difficulties when business is down for several months in succession.

Industry Jitters

The television industry finds itself in a bad spot with color TV still bogged down in the laboratories while the industry stumbles along producing and selling monochrome receivers at no profit to anyone. Just how long this situation will exist is still anyone's guess. Some industry factors feel that color sets will not be produced in volume until a simpler tube that will produce a picture comparable in size to the present twenty-one inch monochrome tubes, is developed.

RCA's program of producing and aggressively promoting their current set with the 15" tube is an attempt to duplicate, on a smaller scale, the spectacular merchandising success they achieved back in 1946 when they went all out on black-and-white TV. Should this happen; should the public accept and buy the present RCA color receivers at the price of one-thousand dollars and over-buy RCA's currently planned production, the industry would be up to its ears in color set production before the end of the year.

However, even the maximum possible production of color TV receivers during the last half of this year would provide little, if any, business to the independent servicing industry. For the protection of their brand names, TV set manufacturers will have to supervise the placement of the installation and service work on their color receivers until all of the bugs have been taken out of production-line sets. This means, simply, that independent service shop operators should not look to color TV to add to their business volume for quite some time.

Everyone had hoped that the rapid expansion of TV through the addition of hundreds of u.h.f. stations would provide a product and service market that would tide the industry through to the time that color would be available in volume and at prices the average set

the sensational
**"QUICK-HOT"
 SOLDERING GUN**



**Built-In
 Spotlight** ➔

STEVE-EL "jumped the gun" by introducing the "QUICK-HOT" before anybody else. We have never been so excited about a soldering gun development as we are about "QUICK-HOT." It is without a doubt, the most efficient soldering gun of all 175 watt guns.

- Extra long narrow tip for easy reach.
- Built-in spotlight.
- Lifetime tip.
- Soldering heat in 2½ seconds.

\$ 5³⁰ ONLY lots of 3
\$5.96 each

EXTRA SPECIAL!
 16 RP4
 PICTURE TUBE
 \$16.49
 Brand new. Guaranteed 1 year

FREE! Write Dept. RN-7 for New BARGAIN BULLETIN

STEVE-EL Electronics Corp.
 61 Reade St. New York 7, N. Y.

The **MAGNEMITE**
in Action Around the World!



- Dawson recording deep in Africa's Gold Coast.
- American Museum expedition in ranges of New Guinea.
- Dwight Cooke interviews for CBS all over Asia.

Wherever you go, whether it be to the North Pole or the bottom of an African diamond mine, it's not too far for the Magnemite, truly portable tape recorder, whose versatility and unfailing dependability has gained global popularity for itself.



You'll never grow tired carrying a Magnemite, since these units weigh as little as 15 lbs. complete with batteries. Letterhead size, this mighty little handful meets NARTB standards and will easily satisfy your most critical recording needs.

For the whole MAGNEMITE story write to Dept. RT

AMPLIFIER CORP. of AMERICA
 398 Broadway, N. Y. 13, N. Y.

July, 1954

owner could afford to pay. But it is not working out that way. Ultra-high-frequency telecasting is bogging down badly and interest in building new u.h.f. stations is fast waning.

Space does not permit a discussion of the factors involved in the general failure of u.h.f. to take hold nor of the several plans put forward to keep it from going the way of FM. However, nothing spectacular will be accomplished that will add materially to the volume of service business in the months ahead.

Jobber Sales to Public

The tightening market for service is bringing many of the adverse factors that affect the business of servicing into sharp focus. Second only to the evils of inadequate pricing of service labor, the bugaboo of service that is most often the subject of letters from our readers is that of the indiscriminate sale of replacement parts, tubes, and accessories by parts distributors.

The big question that has been posed by dozens of service business operators who have written your editor is this—"Are parts distributors 'jobbers' or 'retailers'?" There is no denying the fact that the availability of dealer net price lists to the public generally presents a very serious problem to every service businessman in his relations with his customers when he honestly presents itemized lists of parts and tubes used in repairing a TV or radio set.

Although over-the-counter selling of replacement parts and tubes indiscriminately to everyone who walks into a distributor's store is felt most seriously by service operators in metropolitan areas, the condition has been rapidly fanning out into all areas as many parts jobbers press for the last penny of business they can squeeze out of the areas where they operate. It is not a healthy condition for the industry itself for it could bring about an acceptance of dealer net prices as actual retail prices which, in turn, would eventually force a change in the entire pattern of parts and tube distribution.

In a "do-it-yourself" book recently published to encourage the average set owner to repair his own TV set, the author devotes one chapter to advising the reader how to save money on the cost of tubes and parts by buying them from any one of the numerous radio jobbers or wholesalers who are anxious to sell him. The writer of this book tells his readers that tube list prices are meaningless and explains how tube bargains are made possible by set manufacturers dumping surplus tubes with parts distributors at less than manufacturers' cost.

It is extremely doubtful whether one person out of ten-thousand set owners who might read this book could successfully service his own set from the instructions it gives. Yet every set owner who might read it would long remember that "list prices are meaningless" and be influenced by the inference that only a sucker pays list prices for tubes and parts used in repairing TV or radio sets.

*Heard
 the news?*



Centralab

has a
NEW
48-page
catalog

It brings you up to date on the latest developments in America's most complete line of volume controls, switches, capacitors, Printed Electronic Circuits*, and seatite insulators.

*Get your
 free copy*

Tear out the coupon
 in the **Centralab**
 announcement on
 page 21

*Trademark

new, improved
lapel mike



the
TURNER L-100

with exclusive
adjustable clip

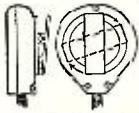

The handiest, low-cost lapel mike on the market. Highest quality Bimorph moisture-sealed crystal gives excellent voice reproduction. A tough alligator clip really holds — it's rubber padded, can't tear your clothing. And the clip is adjustable — you can clip on the Turner L-100 from any angle and the mike stays straight up, cord hangs straight down. Unit is 2-in. diam., weighs 1 oz. less cable. Response, 50-10,000 c.p.s.; level, -52 db. Available without clip, and with ceramic interior. Ceramic interior specifications — response, 80-9,000 c.p.s.; level, -61 db.
Model L-100 (with clip and 20-ft. cable)
List Price: \$12.50

Model 100 (without clip and with 7-ft. cable) ----- List Price: \$ 8.00

Model L-100C (same as L-100 but with ceramic interior) ----- List Price: \$12.50

Model 100C (same as Model 100 but with ceramic interior) List Price: \$ 8.00



THE TURNER COMPANY

900 17th St. N.E.
Cedar Rapids, Iowa

MAIL THIS COUPON TODAY
for complete information

I want all the facts on the new
Turner L-100

Name _____

Address _____

City _____

State _____

Experienced service operators know from experience that it is unwise to list in complete detail the parts, tubes, and accessories used in making a set repair. Many a service technician has had an embarrassing time in trying to explain to a customer why he charged two dollars for a tube when the customer knows he can get it for less at a distributor or from a mail-order house.

Fortunately, in many areas parts distributors sell only to *bona fide* service shop operators. Where this is done, service accounts have been classified and service shops given means of identification which entitle them to buy at dealer net prices.

Unfortunately, the problems involved in channeling the distribution of replacement tubes, parts, and supplies so that only legitimate service businesses would be able to buy at dealer net prices are very complex. The electronics manufacturing industry is, in itself, a highly diversified and complicated industry and within its framework are many elements that use tubes and components in far greater volume than the retail servicing industry. Then, too, there are large segments not connected with service who, in the aggregate, buy substantial quantities of the products used in service but are not directly concerned with set servicing.

Consider, for a moment, the needs of radio hams, hobbyists, and experimenters. Amateur radio enthusiasts were tinkering with wireless long before we had commercial radio broadcasting. They have been constantly in the forefront of electronic developments and much of the industry's progress can be traced to experiments by amateurs at their own expense. The network of amateurs that blankets the country is one of the country's most effective—and from a tax standpoint, inexpensive—defense organizations and invaluable when disaster strikes anywhere. No one would deny the radio amateur the right to purchase the equipment, tubes, supplies, and parts he needs to pursue his hobby at the best possible price.

Then there are thousands of electronic hobbyists and experimenters who are as avidly enthusiastic about their avocation as are the model railroaders, woodworkers, auto enthusiasts, and model plane builders. They are also confirmed shoppers in getting the material they need at the lowest possible price. The confirmed hi-fi enthusiast falls into this category and, of course, if he can't buy hi-fi equipment locally at dealer net prices, he will order from a mail-order concern. And in this connection, it should be pointed out that if the present mail order sales structure were not in existence there would be manufacturers who would be producing and selling hi-fi units to the general public by mail.

In total, it is estimated that there are possibly a half million electronically-interested people sufficiently conversant with circuitry and components who would seek out sources of supply

Solves the
**SMALL PARTS
STORAGE PROBLEM**

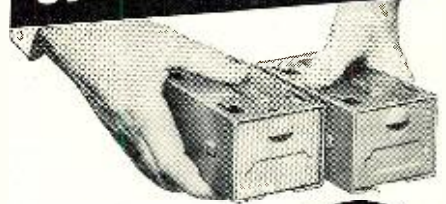

**ALL-STEEL MULTI
INTERLOCKING DRAWERS**

Multi-Drawers are handy all-steel storage cabinets perfect for storing easily-lost small parts like condensers, small tubes, switches, nuts and bolts! Precision-made, finished in durable two-tone green enamel, complete with card holder. Available at your dealer's in two sizes—42c ea. in the small size (illus.), \$1.28 for the large.

EASY TO ASSEMBLE

*Units interlock rigidly at top, bottom, sides to fit any space.

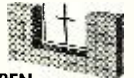
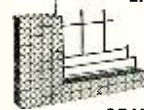

SOME DEALERSHIPS OPEN

*Once again, enough steel is available to make Multi-Drawers available to new dealers! Write today.

**THE CINCINNATI
VENTILATING CO. INC.**
THIRD & MADISON STS., COVINGTON, KY.

EASY TO LEARN CODE

It is easy to learn or increase speed with an Instructograph Code Teacher. Affords the quickest and most practical method yet developed. For beginners or advanced students. Available tapes from beginner's alphabet to typical messages on all subjects. Speed range 5 to 40 WPM. Always ready—no QRM.



ENDORSED BY THOUSANDS!

The Instructograph Code Teacher literally takes the place of an operator-instructor and enables anyone to learn and master code without further assistance. Thousands of successful operators have "acquired the code" with the Instructograph System. Write today for convenient rental and purchase plans.

INSTRUCTOGRAPH COMPANY

4711 SHERIDAN ROAD, CHICAGO 40, ILLINOIS

Get Your **F.C.C. LICENSE** Quickly!

Correspondence or residence preparation for F.C.C. examinations. Results guaranteed.

An FCC commercial operator license means greater opportunities and higher pay. We are specialists in preparing you, in a MINIMUM OF TIME, to pass FCC examinations for all classes of licenses. Beginners get 2nd class license in 5 weeks and 1st class in 3 additional weeks. Write for free booklet.

GRANTHAM SCHOOL OF ELECTRONICS

Dept. 103-B, 6064 Hollywood Blvd., Hollywood 28, Calif.

MINIATURIZING??

Metalclad

PRINTED CIRCUIT KIT

For your Electronic Circuit

6"x6" Copper Clad Phenolic Sheet, Resist Solution, Etch and Instructions, No photography required, Order direct from factory. **\$1.95** No C.O.D.

TRANSCIRCUITS

2105 W. 42d, Kansas City 3, Kansas

RADIO & TELEVISION NEWS

at the best possible prices. While this is a healthy number of people, they represent only a small segment of the TV set-owning public. It is doubtful whether their purchases of components to service sets represent any serious threat to the stability of service as a business activity.

Consider the problem of a parts distributor who would like to restrict his sales at dealer net prices to people actually engaged in service as a business. If there is no effective, representative service association in existence in his area, who is he to work with in developing the classifications of recognized service businesses? Also, effective cooperation is a two-way street. If parts distributors sell only to classified legitimate service businesses, these service businesses should buy all of their replacement tubes, parts, supplies, and equipment from the cooperating distributors.

In discussing this problem with a parts distributor recently, your editor was told that this distributor had attempted to work out a restricted sale plan with his service customers. The plan seemed to be working well until a hot-shot parts peddler made a trip through the territory and a number of the protected service accounts loaded up on unboxed replacement tubes that the peddler was selling. Needless to say, this stopped the cooperative plan cold in its tracks.

The ready availability of TV picture tubes at dealer net prices in indiscriminate over-the-counter selling by many parts jobbers has done more than anything else to aggravate service relationships with set owners. Since this is one product for which the use is clearly identified, sales could be confined to properly qualified service operators.

An outstanding example of how stability in service can be achieved through service association—parts distributor cooperation is evident in Columbus, Ohio, where the Associated Radio-Television Service Dealers have worked closely with their set and parts distributors for many years. ARTSD of Columbus is the oldest service business association in the industry. Since its inception, this association has maintained a dynamic attitude that is reflected in the broad scope of the programs they initiate and carry out. One of the most important facets of their program is their quarterly meetings with all local parts distributors to discuss and settle any problems that mutually concern them. These quarterly get-togethers with parts distributors are dinner meetings at which the distributors are the guests of the association. Gripes are freely aired by service businessmen and the parts distributors and steps taken to correct any situation that may adversely affect either the distributors or the local service businesses.

Service Conventions

The Texas Electronic Association is completing plans for the second TV Service Clinic and Electronics Fair to be held at the Adolphus Hotel, Dallas, July, 1954

NOW MEASURE MOBILE-RADIO RIGS UP TO 500 MC!

Make frequency and FM deviation checks on unlimited numbers of channels with just these 2 meters!



LAMPKIN 105-B MICROMETER FREQUENCY METER

Uses one crystal to measure all transmitters from 0.1 to 175 mc., and crystal-controlled transmitters to 500 mc. Gives readings of percent error from assigned frequencies. Acts as precision CW signal generator for receiver final alignment. \$220.00.

PORTABLE—Width less than 13"... weight less than 14 lbs., each.

MEET FCC REQUIREMENTS — for mobile-service checks.

For low prices... and technical data... mail coupon today!



LAMPKIN 205-A FM MODULATION METER

Direct indication of peak voice deviation, 0-25 kc positive or negative. Tunable 25-500 mc. in one band. Doubles as relative field-strength meter. Built-in speaker. Jack for oscilloscope. \$240.00.

LAMPKIN LABORATORIES, INC.
Bradenton, Florida

LAMPKIN LABORATORIES, INC.
MFM DIVISION
BRADENTON, FLORIDA

Without obligation, please send me data on Lampkin meters.

Name _____
Street _____
City _____ State _____

POWERFUL ALNICO MAGNETS!!!

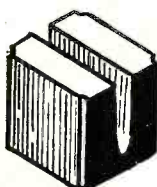

Just a few of the many types always in stock:
POLISHED BAR—9/16"x7/32"x3/32" 12/\$1.00; 100/\$7.50
"U" TYPE—3/4"x5/8"x1/4" 68, 49¢; 12/\$5.00
RING TYPE—1/16" O.D., 3/8" I.D., 5/16" deep. ea. 79¢; 6/\$4.25
"HEELING MAGNETS"—Set of 2 round 5/8" O.D. bars, 4 1/2" & 1 3/4" L. Wood cased \$1.98
ALNICO MAGNET KIT—Powerful Bar, Block, "U," Rod, etc. Kit of 10 ass'd \$1.98

(WRITE FOR LATEST "ALNICO" SUPPLEMENT)

1" FIBREGLASS ACOUSTICAL CABINET LINING. 36" wide. per running ft. 1.15
AUTO RADIO ANTENNAS—3 section, 63" CHROMED BRASS, With 36" shielded cable; side owl. 2.29
115 V. AC ELECTROMAGNET—6 oz. pull, cont. duty, 1" O.D. x 7/8" ea. 98¢; 6/\$5.00
HI-FI CRYSTAL HAND MIKE—Rugged, all-purpose, hi-impedance, 3/2" ft. shielded cable. 3.95
"QUAKER" INPUT TRANSFORMER (1 1/2"x7 1/2")—S.B. carbon mike to grid. ea. 98¢; 6/\$5.00

!!XMAS IN JULY!!

when you get the NEW "JUMBO RADIO ELECTRONICS PARTS KIT"—LOADED with new & surplus inventory odds & ends. WORTH SEVERAL TIMES THE PRICE!!—17 lbs. of SWITCHES, CONTROLS, SOCKETS, WIRE, TV PARTS & DIAGRAMS, PHOTOFACTS, COILS, RESISTORS, CONDENSERS, ETC., ETC. \$3.95 (Shpg. wt. 20 lbs.)

CABINET DRAW SLIDES

Heavy duty, for any changer, amplifier, etc. All-steel, silent ball-bearing, 13" overall lgh; 9" extension. per pair 2.49
CABINET LID STUPOPTS (stay hinges)—holds at any angle to 70°. Bronze finish. ea. 39¢; 6/1.98
HS-30 HEADSETS complete with matching xfmr. 2.49
HS-30 TRANSFORMER only. ea. 59¢; 10/\$5.00
2000 OHM LAB. POTENTIOMETER (DeJury) ea. 98¢; 6/\$5.00
±5% W.W., 3" O.D., bakelite shaft. ea. 98¢; 6/\$5.00

!!REPAIR YOUR OWN SPEAKERS!!

SPEAKER REPLACEMENT CONES—An assortment of popular sizes 4" to 12", incl. oval. Less voice coils. Kit of 12 ass'd. 1.98
SPEAKER REPAIR KIT—Professional assortment of Voice Coil Forms, Rings, Spiders, Felt, Chamois Lthr., Shim Kit, Cement & Instructions. 2.49
!!SPECIAL!!—BOTH CONE & REPAIR KITS for ONLY \$3.95

"DIRECT FACTORY SPEAKER REPAIRS SINCE 1927" Min. Order \$3.00. 20% deposit req. on all C.O.D.'s. Please add sufficient postage—excess refunded.

LEOTONE RADIO CORP.
67 Dey Street
New York 7, N. Y.

SAVE HOURS OF WORK

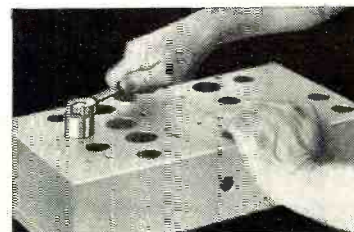

quickly make round, square, key and "D" openings with Greenlee Radio Chassis Punches

In 1 1/2 minutes or less you can make a smooth, accurate hole in metal, bakelite or hard rubber with a GREENLEE Punch. Easy to operate . . . simply turn with an ordinary wrench. Wide range of sizes. Write for details. Greenlee Tool Co., 1887 Columbia Ave., Rockford, Ill.



STAN-BURN E.P.A.D.K.E.

CATHODE RAY TUBE SPECIALS

One Year Guarantee		STAN-BURN	
G. E.		STAN-BURN	
10BP4A	\$14.95	10BP4	\$10.20
10FP4A	21.10	12LP4	11.90
12KP4A	24.45	12LP4A	13.95
12LP4A	18.75	12QP4	11.90
12QP4/B1014		12JP4	11.90
Dumont	21.00	12UP4A	14.50
12UP4B	28.75	14CP4	15.60
14CP4	24.50	15DP4	17.50
15DP4/B1014		16KP4	17.50
Dumont	23.75	16DP4 or A	17.50
16AP4A	30.95	16JP4 or A	17.50
16DP4A (N.U.)	25.25	16CP4 or A	17.50
16GP4 or B	31.25	16FP4	17.50
16KP4/16RP4	24.20	16WP4	17.50
16KP4A		16AP4	17.50
(Aluminum)	28.35	16AP4A	23.00
16JP4A (N.U.)	25.25	16EP4	19.00
16LP4A	28.50	16EP4A	23.50
16WP4A	26.50	16GP4 or A	21.00
16CP4B	31.25	17BP4A	18.50
17BP4A	24.25	17CP4A	21.60
17BP4B	30.30	17GP4B	22.60
17CP4	23.90	19FP4	23.00
17CP4B		19FP4A	24.00
(Aluminum)	29.00	19AP4	23.90
19AP4A	41.50	19AP4A	24.90
20CP4	30.00	20CP4	23.95
20LP4	37.50	21EP4	25.50
21AP4	42.00	21EP4A	26.50
21EP4	31.80	24AP4	49.00
21EP4A	36.35		
24AP4	78.50		

QUANTITY CRT USERS
We will give you DUD allowances if you ship them to us Prepaid 10 CRT's minimum shipment. WRITE FOR DETAILS.

ANTENNAE SPECIALS

RE-DOUBLE TV Antenna	1-5	6 or more
10 ELEMENT CONICAL	\$2.19	\$1.98
DOWELED INSERTS	2.98	2.79
Folded Hi Straight Low Quick Rig		
1/2 elements	4.25	3.25
WINDOW CONICALS	4.95	3.75
MASTS		
5 FOOT SWEDGED	.79	.69
20 FOOT PLAIN	1.39	1.29
NEPCO MASTS	1.69	1.49
TV WIRE		
42 Mtl.	\$ 9.95 M Ft.	
55 Mtl.	11.95 M Ft.	
72 OHM COAXIAL	35.00 M Ft.	

CHASSIS 630 TECH-MASTER	
Model 1930 with Cascade Tuner	\$149.50
OPEN FACE CABINET	42.00
TAPE RECORDERS IN STOCK	
PENTRON - Model 9T3C - 2-speed Tape Recorder	Write for Price.
RADIO CRAFTSMAN	
Model C400-Hi-Fi Amplifier	Net 42.90
Model C10-AM-FM Tuner	Net 131.50
Model C50-Williamson Amplifier	Net 99.50
We also carry MASCO-BOGEN-PILOT, etc. Amplifiers, Pre-Amps, FM Tuners and WEBSTER Tape Recorders.	
6x9 PM Speaker	\$ 3.98
7" PM Speaker	3.98
70" Yoke	1.98
630 Vert. output	1.98
upright	1.98
630 Vert. output	1.29
potted	1.29
630 Vert. Blocking	.89
OSC. XForm	14.95
Cascade Tuners	14.95
Dumont	21.25
Famous Inputuner	10.00
TV Permanent Magnet	1.98
Focus Assembly	1.98
THREE SPEED AUTOMATIC VM RECORD PLAYER in Portable Carrying Case, Special	\$39.95
20CP4 Progressive	Special \$23.95

AUTHORIZED DISTRIBUTORS for General Electric, Kenrad, Tung-Sol, National Union, De Wold, Regal, Automatic and General Motors. Automatic Custom-Built Radios for Plymouth, Ford, Chevrolet and many others, always in stock. We carry a Complete line of HI-FIDELITY and sound equipment. Send us your requests. We also carry a complete line of popular makes of Radio Tubes at 50/10 discount. Also many other special purpose and transmitting types, and all electronic parts and equipment at lowest prices. Send us a list of your requirements for prompt quotations. Terms: 20% with order. Balance C.O.D. All prices F.O.B. NEW YORK Warehouse. Minimum order \$5.00. Write for our latest price list and Hi-Fi catalog to Dept. RN-7.

STAN-BURN RADIO and ELECTRONICS CO.
1697 BROADWAY • NEW YORK 19, N. Y.

RADIO and TELEVISION ELECTRONICS

RCA in all Technical Phases
New Classes (Day and Evening) Start 1st of Dec., Mar., June, Sept.

Free Placement Service for Graduates
For Free Catalog write Dept. RN

RCA INSTITUTES, INC.
A Service of Radio Corporation of America
350 WEST 4TH ST., NEW YORK 14, N. Y.

ARKAY KITS WORLD'S FINEST

RADIOS PHONOGRAPHS TV
TEST EQUIPMENT HI-FI

Write for FREE Brochure

RADIO KITS, INC. • 120 Cedar St., N. Y. 6

Texas, on August 27, 28, and 29 (Friday to Sunday). The service clinic held in Fort Worth during August, 1953, achieved national recognition as one of the outstanding meetings of its kind in the nation. Subjects to be discussed at the 1954 clinic include color TV, u.h.f., transistors, TV antennas, fair charges for TV service, selling TV service, credits and collections, and bookkeeping systems.

The NATESA annual convention is scheduled to be held in Chicago on September 24th, 25th, and 26th. Although program details have not been announced, the convention will feature a series of clinical sessions on subjects of top importance to service business operators.

Adequate Service Labor Charges

One of the most heartening developments in the independent servicing industry in years is the growing interest among service business operators everywhere in lifting their sights and getting adequate charges for their labor. Letters from readers praising the efforts of this department to stimulate sensible thinking on service practices have come from every section of the country. The three price charts TVL-1 and TVL-2, for TV labor charges, and RPS-1 for radio-phonograph service charges, are now being used as a pattern by many service groups and as set owner mailing pieces by several service associations.

Information on these charts and other bulletins available from the Bureau may be had by sending a stamped, self addressed envelope to the TTLB Special Services Dept., P. O. Box 1321, Indianapolis, Ind. -30-

Within the Industry (Continued from page 28)

joined *Shura-tone Products, Inc.* as sales manager . . . **DAVID J. BENNETT**, vice-president and general manager of station WTPA, has been elected president of Pennsylvania Association of Broadcasters . . . **CHARLES A. HANSEN** has been appointed manager of the distributor division of *Gramer Transformer Corporation* of Chicago. He previously held the post of sales manager with *Jensen Mfg. Co.*

JOSEPH A. HATCHWELL, Mid-Atlantic regional sales manager for *Allen B. DuMont's* TV receiver division, has been promoted to director of service.

His new responsibilities include the administration, supervision, and direction of the technical activities of the division's service department on a national basis. The department is responsible for service training and follow-through at the distributor, dealer, and independent service organization level. -30-



Servicing Hi-Fi (Continued from page 57)

to make such repairs to any greater extent than to replace a worn pickup stylus or to cement a damaged loud-speaker cone.

The major electromechanical component in any sound reproducing system which may require any extensive amount of service is the record player—and particularly record changer mechanisms. Since the various units of different manufacture generally differ considerably, it is desirable to have available a set of service instructions for the particular unit on which any work is to be done, but there are several rules which can be followed for all types of units.

When first installed, such units should be tested thoroughly for proper operation and performance. Turntables should be level, and the units should float freely when they are mounted on springs. Record changers should be tested through their complete cycle to see that they are operating properly. Turntable speeds should be checked with a stroboscopic disc under standard operating conditions, with the appropriate number of records on the turntable and the stylus on the record. The sound output should be listened to for quality, to insure that there is no excessive distortion or noise introduced through improper performance of the turntable mechanism or the pickup cartridge. Once the unit is in operation, the mechanism should be periodically cleaned and lubricated, with care being taken to avoid excessive lubrication and to prevent any of the lubricant from coming in contact with the motor drive pulley, the idler wheel rubber tire, or the turntable drive rim.

The failures which may occur in record-player mechanisms fall into a number of definite categories and the service procedures depend upon the specific type of failure.

1. Turntable rotation failure—the motor should be checked to see that it receives power. If there is voltage at the motor, check to see if it is binding anywhere due to damaged or frozen bearings, or to gummed oil and foreign material between its armature and pole pieces. The idler wheel should turn properly and make contact with the turntable drive rim. The turntable should be checked to see that it is not binding and that its bearings are not defective.

2. Improper operation during record change cycle—the records should be visually inspected for correct size, evidence of warping, damage, size of center-hole, and correct run-in and cutoff grooves. Spring tensions should be checked, as well as the adjustments of clutches, cams, and trip levers. The center post should be inspected for evidence of damage or bending.

3. Incorrect tone arm indexing and

QUARTZ CRYSTALS

FT-243-.093" PIN DIA.—.486" PIN SPC

FOR HAM AND GENERAL USE • GUARANTEED

4035 5500 5925 6425 7450 7650 7875	1015 6150 6650 7400 8400
4080 5675 5940 6673 7473 7900	2125 6175 7000 7425 8425
4110 5700 5950 6675 7475 7906	2500 6200 7025 7440 8450
4165 5706 5973 6700 7500 7925	3640 6440 7050 8025 8475
4190 5725 6240 6706 7506 7706 7940	3680 6450 7075 8050 8500
4280 5740 6250 6725 7525 7720 7950	3735 6473 7100 8075 8525
4300 5750 6273 6750 7540 7725 7973	3760 6475 7125 8100 8550
4397 5773 6275 6775 7550 7740 7975	3800 6500 7150 8125 8575
4490 5805 6300 6800 7573 7750 8206	3855 6506 7175 8150 8583
4495 5840 6325 6825 7575 7773 8225	6000 6550 7200 8173 8600
4930 5850 6340 6850 7600 7775 8250	6025 6573 7300 8175 8625
5030 5852 6350 6875 7606 7800 8273	6050 6575 7306 8200 8650
5205 5873 6373 6900 7610 7825 8275	6075 6600 7325 8340 8700
5300 5875 6375 6925 7625 7840 8300	6100 6606 7340 8350 8733
5385 5880 6400 6950 7640 7850 8325	6125 6625 7350 8375
5485 5906 6406 6975 7641 7873	6140 6640 7375 8380

49c each—10 for \$4.00 99c each—10 for \$8.00

Low Frequency—FT-241A for 33B, Lattice Filter etc., .093" Pins, .486" SPC, marked in Channel Nos. 0 to 79, 54th Harmonic and 270 to 389, 72nd Harmonic. Listed below by Fundamental Frequencies, fractions omitted.

370 393 414 437 501 522 400 461	5910
372 394 415 438 502 523 400 462	6370
374 395 416 439 503 524 401 463	6450
375 396 418 483 504 526 442 464	6470
376 397 419 484 505 527 444 465	6497
377 398 420 485 506 529 445 466	6522
379 401 422 486 507 530 446 468	6547
380 402 423 487 508 531 447 469	6560
381 403 424 488 509 533 448 470	7350
383 404 425 490 511 534 450 472	7380
384 405 426 491 512 536 451 473	7390
385 406 427 492 513 537 452 474	7480
386 407 429 493 514 538 453 475	7580
387 408 430 494 515 454 476	7510
388 409 431 495 516 455 477	7930
390 411 433 496 518 457 479	
391 412 435 497 519 458 480	
392 413 436 498 520 459	

FT171B BC-610 2 Banana Plugs 3/4" SPC

2030 2220 2360 3202 3570	522
2045 2258 2390 3215 3580	522
2065 2260 2415 3237 2945	522
2082 2282 2435 3250 3553	522
2105 2290 2442 3322 3395	522
2125 2300 2532 3510	522
2145 2305 2545 3520	522
2155 2320 2557 3550	522

BC745 TUNING UNITS, CHANNELS 10 AND 12—foundation coils and condenser for 80 meter VFO or exciter—less tubes

SEE ARTICLE BY W3PPQ IN MARCH '54 CQ.

add 20c postage for every 10 crystals (or less)

49c each—10 for \$4.00 99c each—10 for \$8.00

Spec.—200 KC without holder—29c, 3 for \$1.00

Spec.—200 KC or 500 KC in FT241A Holder, \$1.79 ea.



520 TENTH ST. N. W.—WASH. D. C., DEPT. N

STAY ON THE AIR WHEN POWER FAILS...with an ONAN Electric Plant



Model 10EL, 10KW A.C.

When storms, floods, or fires interrupt electricity and force you off the air, you lose listeners and income. Guard against loss, assure vital public service during emergencies by installing an Onan Electric Plant. Onan Standby Electric plants serve many network and private stations. Gasoline driven automatic models to 50,000 watts.

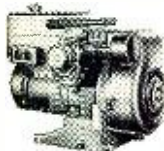

PORTABLE ELECTRIC PLANTS FOR MOBILE RADIO USES Supply A.C. power for broadcasting at scene of events. Light in weight. Can be carried by hand or in trunk of car. A.C. models: 400 to 3,500 watts.

Write for FREE Folder

D. W. ONAN & SONS INC.
7903 University Avenue
Minneapolis 14, Minnesota

July, 1954

needle pressure—spring tensions and the adjustment of level and guide pin assemblies should be checked. The tone arm counterbalance spring should be adjusted for the correct needle pressure, and the tone arm bearing should be checked for binding.

4. Rumble, wow, or slow speed of rotation—check for damaged or worn rubber rim or flat spots on idler wheel, damaged or poorly lubricated motor or turntable bearings, slipping of idler wheel due to weak spring tension or to oil on rubber rim, record slipping on record below due to warping, records not properly aligned on turntable.

5. Noise and squeaks—rubber idler wheel may be bumpy or out of round. If a squeak is due to the records rubbing against the center-post, it may be removed by lightly coating the center-post with wax or Vaseline to eliminate friction.

6. Hum, distortion, lack of output—check for shorted or open pickup leads or shielded cable, defective pickup cartridge or stylus, or leakage through output plug.

If the procedures outlined are following of the installation and servicing of the electronic and mechanical components, then the sound reproduction of the system will be maintained at the standards to which it was designed.

R.F. in Audio Systems

(Continued from page 45)

control can be reduced by shunting a resistor across one side of the control and ground. The resistor should be five to ten times the control impedance. A small condenser, perhaps 50 μ fd., can be tried instead of the resistor. It may also help to insert a 2 or 3 millihenry shielded choke in series with the control. Such remedies should always be followed by a check on the frequency response and other performance characteristics of the unit.

The writer was aided in the preparation of these articles by data furnished by broadcast personnel, manufacturers, and other agencies and individuals too numerous to acknowledge by name. However, particular thanks are due Dr. Halley Wolfe, co-author of "Elements of Sound Recording" for his advice on the filter shown in Fig. 2 and other points, to his publisher, John Wiley and Sons, for permission to use illustrations from the book, and to Mr. Robert B. Monroe of CBS, who kindly read the manuscript and offered many valuable suggestions.

REFERENCES

1. Augustadt & Kammerberg: "Longitudinal Noise in Audio Circuits," *Audio Engineering*, January and February 1950.
2. Frayne & Wolfe: "Elements of Sound Recording," John Wiley and Sons, page 193.
3. Hicks, H. J.: "Principles and Practice of Radio Servicing," McGraw-Hill Book Company, page 152, Second edition.
4. Langford-Smith, F.: "Radiotron Designer's Handbook," Radio Corporation of America, page 636, Fourth edition.
5. Maxwell, Ken: "FM Interference," *RADIO & TELEVISION NEWS*, February 1951.

BUILD 15 RADIOS

AT HOME ONLY
With the New Improved 1954 \$19.95
Progressive Radio "EDU-KIT"

NOW INCLUDES
SIGNAL TRACER
and
CODE OSCILLATOR

• ABSOLUTELY NO KNOWLEDGE OF RADIO NECESSARY

• NO ADDITIONAL PARTS NEEDED

• EXCELLENT BACKGROUND FOR TELEVISION

• SCHOOL INQUIRIES INVITED

• FREE SOLDERING IRON

• 10-DAY MONEY-BACK GUARANTEE

WHAT THE PROGRESSIVE RADIO "EDU-KIT" OFFERS YOU

The "Edu-Kit" offers you a Home Radio Technician Course at a rock-bottom price. You will learn how to identify Radio Symbols and Diagrams; how to build radios, using regular radio schematics; how to wire and solder in a professional manner. You will learn how to operate Receivers, Transmitters, and Audio Amplifiers. You will learn how to service and trouble-shoot radios. You will learn code. You will receive training for F.C.C. license. In brief, you will receive a practical basic education in Radio, worth many times the small price you pay.

THE KIT FOR EVERYONE

It is not necessary that you have even the slightest background in science or radio. The "Edu-Kit" is used by young and old; by radio schools and clubs; by Armed Forces personnel and veterans for training and rehabilitation. No instructor is required. Instructions are complete, simple and clear. You cannot make a mistake.

PROGRESSIVE TEACHING METHOD

The "Edu-Kit" uses the principle "Learn by Doing." Therefore you will build radios, perform jobs, and conduct experiments to illustrate the principles which you learn. You begin by learning the function and theory of each of the radio parts. Then you build a simple radio. Gradually in a progressive manner, you will find yourself constructing more advanced multi-tube radio sets, and doing work like a professional Radio Technician. The "Edu-Kit" Instruction Books are exceedingly clear in their explanations, photographs and diagrams. These sets operate on 105-125 V. AC-DC. An adaptor for 210-250 V. AC-DC is available.

The Progressive Radio "EDU-KIT" Is Complete

You will receive every part necessary to build fifteen different radio sets. Our kits contain tubes, tube sockets, chassis, variable condensers, electrolytic condensers, mica condensers, paper condensers, resistors, line cords, selenium rectifiers, tie strips, coils, hardware, tubing, etc. An Electrical and Radio Tester is included. Complete, easy-to-follow instructions are provided. In addition, the "Edu-Kit" now contains lessons for servicing with the Progressive Signal Tracer, F.C.C. instructions, quizzes. The "Edu-Kit" is a complete radio course, down to the smallest detail.

TROUBLE-SHOOTING LESSONS

Trouble-shooting and servicing are included. You will be taught to recognize and repair troubles. You will build and learn to operate a professional Signal Tracer. You receive an Electrical and Radio Tester, and learn to use it for radio repairs. While you are learning in this practical way, you will be able to do many a repair job for your neighbors and friends and charge fees which will far exceed the cost of the "Edu-Kit." Our Consultation Service will help you with any technical problems which you may have.

FREE EXTRAS

- Electrical & Radio Tester
- Electric Soldering Iron
- Book on Television
- Radio Trouble-Shooting Guide
- Consultation Service
- Quizzes
- F. C. C. Training

ATTRACTIVELY GIFT PACKED

PROGRESSIVE "EDU-KITS" INC.

497 UNION AVE., BKLYN. 11, N.Y., DEPT. RN-31

MAIL TODAY—Order shipped same day received.

10-Day Money-Back Guarantee. Include ALL FREE EXTRAS.

Send "Edu-Kit" Postpaid. I enclose full payment of \$19.95 (U.S.A. only).

Send "Edu-Kit" Postpaid. I enclose full payment of \$20.95 (Outside U.S.A.).

210-250 V. Adaptor for "Edu-Kit"—\$2.50.

Send "Edu-Kit" C.O.D. I will pay \$19.95 plus postage. (U.S. only).

I wish additional information describing "Edu-Kit." No obligation.

Send me FREE Radio-TV Servicing Literature. No obligation.

Name

Address

.....

.....

.....

.....

.....

.....

.....

.....

.....

.....

.....

.....

.....

.....

.....

.....

.....

.....

.....

PROGRESSIVE "EDU-KITS" INC.

497 Union Ave., Bklyn. 11, N.Y., Dept. RN-31

CRYSTALS

ALL CRYSTALS TESTED FOR ACTIVITY BEFORE SHIPMENT AND GUARANTEED TO OSCILLATE! Numbers listed are fundamental frequencies with fractions omitted.

FT-243 CRYSTALS

Lots of 10 or more. Each . . . 69c
Lots of 5 or more. Each . . . 79c
Individually. Each 99c

1110	2450	2715	2995	3310	6373	7500	7980
1129	2455	2720	3005	3320	6375	7510	7990
1150	2460	2725	3010	3340	6405	7520	8000
1195	2465	2730	3015	3410	6406	7530	8006
1525	2470	2740	3020	3420	6425	7540	8008
1900	2475	2745	3025	3455	6440	7550	8010
1915	2480	2750	3030	3465	6450	7560	8015
1930	2485	2755	3035	3510	6473	7570	8020
1940	2490	2760	3040	3525	6475	7580	8025
1950	2495	2765	3045	3550	6500	7590	8030
1965	2505	2770	3050	3655	6506	7600	8033
1977	2510	2775	3055	3700	6525	7610	8040
1980	2515	2780	3060	3825	6540	7620	8041
1985	2520	2785	3065	3885	6550	7630	8050
2010	2525	2790	3070	3940	6573	7640	8058
2015	2530	2795	3075	3955	6575	7650	8060
2017	2535	2815	3080	3980	6600	7660	8066
2020	2540	2825	3085	4025	6606	7667	8070
2029	2550	2830	3090	6000	6625	7670	8073
2035	2557	2835	3095	6006	6640	7680	8075
2040	2560	2840	3100	6025	6650	7690	8083
2055	2565	2845	3105	6040	7000	7700	8100
2060	2570	2850	3110	6042	7006	7710	8108
2067	2575	2855	3115	6050	7025	7720	8115
2090	2580	2860	3120	6073	7040	7730	8116
2105	2585	2865	3125	6075	7050	7740	8125
2125	2590	2870	3130	6100	7073	7750	8130
2130	2595	2875	3135	6106	7075	7760	8133
2135	2600	2880	3140	6125	7100	7770	8140
2140	2603	2885	3145	6140	7106	7780	8141
2145	2605	2890	3150	6142	7125	7783	8150
2155	2610	2895	3155	6150	7140	7790	8160
2165	2615	2900	3160	6173	7150	7800	8163
2175	2620	2905	3165	6175	7173	7810	8166
2180	2625	2910	3170	6185	7175	7820	8170
2195	2630	2915	3175	6205	7200	7830	8173
2300	2635	2920	3180	6206	7206	7840	8180
2305	2640	2925	3185	6225	7225	7850	8183
2320	2645	2930	3190	6235	7240	7860	8190
2350	2650	2935	3195	6240	7273	7870	8191
2355	2655	2940	3200	6250	7275	7880	8200
2360	2660	2945	3202	6273	7300	7890	8206
2365	2665	2950	3205	6275	7306	7891	8208
2370	2675	2955	3210	6300	7325	7900	8220
2375	2680	2960	3220	6306	7340	7910	8225
2390	2685	2965	3225	6315	7350	7920	
2415	2690	2970	3230	6325	7375	7930	
2430	2695	2975	3235	6340	7400	7940	
2435	2700	2980	3240	6340	7406	7950	
2440	2705	2985	3290	6350	7425	7960	
2442	2710	2990	3300	6362	7440	7970	

MISCELLANEOUS & SHIP BAND FREQUENCIES

81.95 KC.	Octal tube type (Used in SCR-584 & SPM-1)	53.99
200 KC.	in FT-241 holder	1.99
200 KC.	Type DC-15 in octal tube base type holder	1.99
327.8 KC.	No. D-168342. (Used in TS-102/4F)	9.95
500 KC.	in FT-241 holder	1.99
1000 KC.	in FT-241 holder	2.49
1000 KC.	Type DC-9, in octal tube base type holder	3.45
2000 KC.	in FT-243 holder	1.99
2142 KC.	in DC-34 holder	2.99
2174 KC.	in DC-34 holder	2.99
2182 KC.	in FT-243 holder	2.99
2500 KC.	in FT-243 holder	1.99
2632 KC.	in FT-243 holder	2.99
2637 KC.	in FT-243 holder	2.99
2638 KC.	in DC-34 holder	2.99
2638 KC.	in FT-243 holder	2.99
2670 KC.	in FT-243 holder	2.99
2647 KC.	in FT-443 holder	2.99
2670 KC.	in DC-34 holder	2.99
2738 KC.	in type 1-C holder	2.99
2738 KC.	in FT-243 holder	2.99
2738 KC.	in MC-7 holder	2.99
3000 KC.	in FT-243 holder	2.99
3088 KC.	in FT-243 holder	2.99
3093 KC.	in FT-243 holder	2.99
3098 KC.	in FT-243 holder	2.99
3103 KC.	in FT-243 holder	2.99
3188 KC.	in FT-243 holder	2.99
3193 KC.	in FT-243 holder	2.99
3198 KC.	in FT-243 holder	2.99
3203 KC.	in FT-243 holder	2.99
5000 KC.	in FT-243 holder	1.99
10,000 KC.	Type SR-5 Bitley, in CR-1 holder	1.99

SEE OUR ADS!

→ June/54 RADIO & TV NEWS Page 75
June 54 C.O.
For COMPLETE LIST of types of crystals, frequencies and prices.
→ WRITE FOR NEW, FREE CRYSTAL CATALOGUE!

NOTE! MINIMUM ORDER \$2.50. ALL ORDERS MUST BE ACCOMPANIED BY CHECK, CASH OR M.O. WITH PAYMENT IN FULL. NO C.O.D. Calif. buyers add sales tax. INCLUDE APPROX. \$5 PER CRYSTAL FOR POSTAGE. DEALERS, JOBBERS: WRITE FOR SPECIAL QUANTITY DISCOUNTS. Items subj. to prior sale & change of price without notice.

U. S. CRYSTALS, INC.

805 S. Union Ave. Los Angeles 17, Cal.

NEW EQUIPMENT FOR THE AUDIO TECHNICIAN

CUSTOM CHASSIS

Scott Radio Laboratories, 1020 N. Rush Street, Chicago, Ill. has released a new radio chassis which has been designed for custom installation.

The Series 1000 has a custom AM-FM tuner and associated amplifier. The chrome-plated chassis mounts the

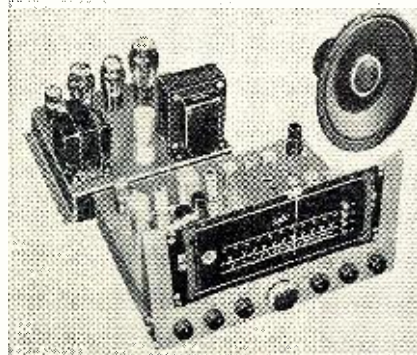

tuner of superheterodyne design with r.f. preamp. The new unit has seven controls including station selector, separate bass and treble tone compensators, and AM sensitivity control.

The power amplifier is built on a separate chrome-plated chassis and supplies power for the tuner. Coverage is from 50 to 20,000 cps with push-pull 6L6 output. The unit comes optionally equipped with a 15" specially matched coaxial speaker.

CONDENSER MICROPHONE

Frank L. Capps & Co., Inc., 20 Addison Place, Valley Stream, N. Y. is in production on a new condenser microphone, the Model CM 2001.

The new unit is designed specifically for hi-fi enthusiasts and professionals. Although the microphone houses a self-contained preamplifier, it is only 1 1/2" in diameter, 6" long, and weighs 12 ounces.

The microphone has a frequency response of 30 to 15,000 cps, ± 3 db. It is omnidirectional and free from angular discrimination, it is blastproof and unaffected by moist atmospheres. It comes complete with cable and power supply.

"ULTRA-LINEAR" TRANSFORMER

Acro Products Company, 369 Shurs Lane, Philadelphia 28, Pa. is now offering its Model TO-330, an "Ultra-Linear" output transformer designed for push-pull parallel "Ultra-Linear" operation of tubes of the KT-66 type.

The new high-power unit has a bandwidth of ± 1 db from 10 to 100,000 cps for the transformer alone and permits the construction of a Williamson-type power amplifier providing 60 watts of output at less than 1% IM

distortion from four KT-66 output tubes.

Data on the TO-330 and circuitry illustrating its application are available on request.

MULTICHANNEL MIXER

Berlant Associates, 4917 W. Jefferson Blvd., Los Angeles 16, California is now offering a 4-channel high-level mixer which can handle any combination of audio inputs and feed any type of output circuit.

By means of plug-in accessories, the basic high-impedance mixer can be adapted to accommodate low-impedance microphones, variable reluctance pickups, and high-level signal sources such as tape recorders, tuners, crystal pickups, etc. Any of these can be mixed in any desired combination.

The new MCM-2 has a built-in power supply which makes it independent of other equipment and insures low hum and high signal-to-noise ratio.

FENTON "ADAPHONE"

Fenton Company, 15 Moore St., New York 4, N. Y. is now offering a small instrument, the "Adaphone," which permits the hard-of-hearing to hear radio or television programs with perfect clarity and comfort at normal loudspeaker volume.

The unit is devised so that the listener can adjust the volume to his individual requirements without disturbing others with normal hearing. A built-in audio volume compression circuit

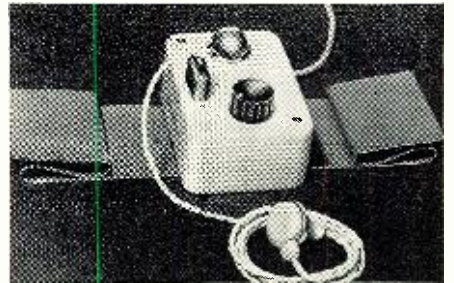

automatically compresses loud passages so essential in some cases of deafness. By alternating output sockets from normal to high tone response, a low cut of near 6 db per octave can be achieved.

HARTLEY TAPE SYSTEM

H. A. Hartley Co. Inc., 521 E. 162nd Street, New York 51, N. Y. is now offering a tape recorder which has three motors and 3 1/4 and 7 1/2 ips speeds.

By means of specially-designed recording and playback heads, flat and undistorted response from 50 to 12,000 cps is obtainable at the 7 1/2 ips speed. The tape deck is normally sup-

plied with three heads for erase, recording, playback and simultaneous monitoring. Two tracks can be recorded so the unit can be equipped for binaural recording on a custom basis.

The company will supply complete specifications on the new recorder and details on companion accessory units upon request.

TAPE CUTTER-SPLICER

Yale Industries Corp., 82-09 251st Street, Bellerose 26, N. Y. has developed a new cutter-splicer for magnetic recording tape which is said to be easier to operate than conventional models.

The TS-4 cuts two rounded indentations in the tape splice which leaves

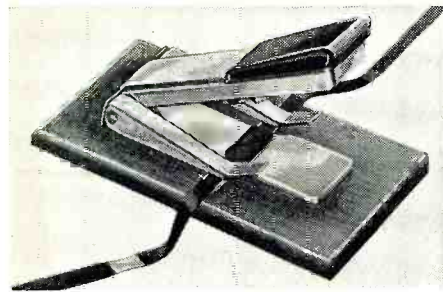

the edges of the tape, which contact parts of the recorder, entirely free from adhesive. This particular unit is designed to handle standard 1/4" wide tape. Splicers for other tape widths are available on special order.

NEW COAXIAL SPEAKER

Stephens Manufacturing Corporation of Culver City, California is in production on a new 12-inch coaxial speaker, the 122AX.

A 2-inch voice coil operates the 12-inch diaphragm from a fully enclosed magnet structure using 1 1/2 pounds of *Alnico V*, thus providing faithful performance down to 40 cps. Coupled through a 5000 cps high-pass filter network are a "Dural" diaphragm and a 1-inch voice coil giving smooth response up to 18,000 cps.

A heavy die-cast aluminum frame and concentric mounting recesses allow exact voice coil clearance for maximum efficiency. Copper voice coils are used to approach the ideal ratio of conductor mass to that of the moving system.

Nominal impedance is 12 ohms, power capacity is 20 watts. The speaker measures 5 1/2" deep by 12 1/4" o.d. Shipping weight is 12 pounds.

ELECTRODYNAMIC PICKUP

Electro-Sonic Laboratories, Inc., 3215 36th Avenue, Long Island City 1, New York is in production on a new phonograph pickup of the electrodynamic type which is designed for hi-fi sound systems.

The output is flat from 20 to 10,000 cps and has a slight rising characteristic to 20,000 cps, depending on the record material.

A tiny loop of fine wire, wound on a *Permalloy* armature, is mounted between the pole pieces of a small but powerful *Alnico* magnet. To one end of the supporting shaft is attached a

Let MILTON S. KIVER Help You Prepare For U.H.F.-TV, Color And...

TELEVISION SERVICING

Easy to TRAIN AT HOME This Practical Way!

Men with the right training in Television Servicing are in big demand . . . pull down big pay. T.C.I. TRAINS YOU RIGHT with easy-to-follow technical training designed by servicemen for servicemen! You learn practical, professional type Television Servicing without leaving your present job. Included are money-making extras such as set conversion, master antenna installation, U.H.F.-TV NTSC Color System and field servicing short cuts. You can start earning Television money after the first few lessons. You learn to test, trouble shoot and repair all types of TV sets the proven, practical way!

HERE'S HOW YOU GET EXPERIENCE!

You train on your own large screen modern television receiver, furnished as part of your course. This set is yours to keep! As an optional feature you can get two weeks of actual field experience out on service jobs and on the repair bench for Chicago's largest independent servicing organization. You learn Television Servicing by actually doing Television Servicing . . . you get the practical know-how you need to qualify for BIG MONEY in this fast-growing field! Age is no barrier, MANY TCI students are over 40!

VETERANS!
T.C.I. is approved for G.I. training under Public Law 550. Check coupon.

ACT NOW! Mail coupon for FREE Catalog and SAMPLE LESSON. Write TODAY!

TELEVISION COMMUNICATIONS INSTITUTE

605 W. Washington Blvd., Dept. BC, Chicago 6, Ill.

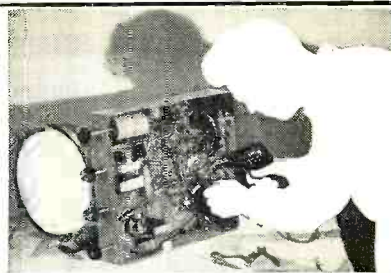

YOU GET and keep modern large screen Television receiver.

YOU DO actual testing, servicing, trouble shooting and repairing

BEGINNERS! LEARN ABOUT NEW BASIC TV COURSE!

You don't need radio experience for practical, home-study training in Basic Television. Start earning money in TV after first few easy lessons. Check coupon for details.

MAIL NOW FOR FREE BOOKLET

MILTON S. KIVER, President
TELEVISION COMMUNICATIONS INSTITUTE
605 W. Washington Blvd., Dept. BC
Chicago 6, Ill.
Rush full facts on practical TV training. I am not obligated. Salesman will not call.

Name Veterans: check here

Address

City Zone State

BEGINNERS check here for information on Basic Television Course.

World's Only Recorder of its Kind WALKIE-RECORDALL 8-13 SELF-POWERED BATTERY RECORDER

***AUTOMATIC UNDETECTED RECORDING** up to 4 hrs. Records noiselessly in or out of closed briefcase, containing hidden mike while walking, riding, lying. Conferences, lectures, dictation, 2-way phone. Permanent, unalterable, indexed recording at only 3c per hr.
***PICKS UP WEAK 50 FT. RADIOS.**
***VOICE ACTIVATED "SELF-START-STOP"**
***NO WIRES OR PLUGS.**

MILES REPRODUCER CO., INC.
812 Broadway, N. Y. 3, N. Y. Dept. RN-7

FACTORY REPAIRS

ON ALL MAKES AND TYPES OF TEST EQUIPMENT

Write Dept. 5 for BIG NEW FREE Catalogue

GENERAL ELECTRONIC DIST. CO.
98 PARK PLACE, NEW YORK 7, N. Y.

Lafayette's Exclusive Sale!

SALE!

MASCODE BOOSTER

5 95 ea.
in lots of 3,
singly, ea. 6.45



List \$29.50

Great Buy

MASCODE MODEL ABV AUTO. ALL CHANNEL VHF 3 TUBE TV BOOSTER

Features a new low-noise cascade circuit. Fully automatic — no tuning. Best for all TV receivers, old or new. Boosts all channels 2 to 13 — automatically! Brings up station strength an average of 13 times on all channels 2 through 13. Low noise factor (approximately 6). Automatically turned on and off by the TV set. Concealed behind TV receiver. Mount it and forget it. Employs new 6BK7-A tube for snow-free reception with new high gain-low noise TV receivers. 3-tube circuit includes two 6T6 tubes in push-pull, cross-neutralized RF amplifier circuit. All-metal cabinet, brown hammertone finish. U/L approved. Undistorted sound and picture on all 12 channels. Engineered for maximum performance. Size 9" x 5" x 3". Shpg. wt. 4 lbs. MODEL ABV VHF-TV BOOSTER.

Lafayette's Greatest Tape Buy Ever!



1200 FT. REEL
Genuine Plastic Base
RECORDING TAPE

\$1.89 per roll plus postage (C.O.D.'s accepted)

LAFAYETTE made a terrific deal with one of the leading manufacturers of recording tape to supply us with their regular tape which sells for almost twice our price. WE GUARANTEE ABSOLUTE SATISFACTION OR YOUR MONEY BACK. The finest, professional-quality recording tape obtainable. Highest performance for thousands of playings. Red Oxide Base in a smooth, uniform coating; greater signal strength; with maximum fidelity; uniform frequency response from 40-15,000 cps.

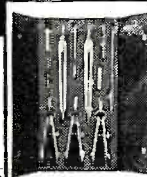

\$2.75

PRECISION DRAFTING SET

11 Pieces—Fitted Felt-Lined Case Made in Germany, of heavy brass, nickel plated and polished. Instruments include 5/16" Compass with pencil and pen points and lengthening bar, 5/16" Divider, three 3/32" sidewheel bow dividers with needle point, pen point and pencil point. 5" Ruling pen, extra handle for pen or pencil, capsule with extra leads. Interchangeability of these many parts makes this an exceptionally versatile set. Your money back—if this set is not worth twice our price! Net 2.75

Lafayette Radio DEPT. RG

Write for free catalogue.
NEW YORK, N.Y. 100 Sixth Ave.
BRONX, N.Y. 542 E. Fordham Rd.
NEWARK, N.J. 24 Central Ave.
PLAINFIELD, N.J. 139 West 2nd St.
BOSTON, MASS. 110 Federal St.

Editors and Engineers

PUBLICATIONS

RADIOTELEPHONE LICENSE MANUAL

Now, in one convenient volume, complete study-guide questions with clear, concise answers for preparation for all U.S.A. commercial radiotelephone operator's license examinations.

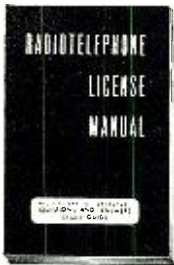

Book No. E&E-RL: \$3.75*

WORLD'S EQUIVALENT TUBES (Equivalents Vade Mecum) NEW 10TH EDITION. A guide reference for the possible exchanges or substitutions of radio tubes, indicating direct or near equivalents for both simple and complex cases, with specialized information as to differences, and covering military tubes as well as conventional types.

Book No. E&E-VM10.....\$5.00*

WORLD'S RADIO TUBES (Brans' Vade Mecum) 9TH EDITION. Lists over 15,000 tubes from every tube making country. Printed in 16 languages.

Book No. E&E-VM9.....\$5.00*

ANTENNA MANUAL. A practical, comprehensive book on antennas, for everyone interested in transmission and reception. Over 300 pages.

Book No. E&E-AM1.....\$3.50*

SURPLUS RADIO CONVERSION MANUAL. VOL. 1. Practical conversions. Write for list of contents. Book No. E&E-SM1.....\$2.50*

SURPLUS RADIO CONVERSION MANUAL. VOL. 2. Companion to Volume 1.

Book No. E&E-SM2.....\$2.50*

*Plus any tax.

Send three cent stamp for circular with detailed contents of books listed.

BUY FROM YOUR DISTRIBUTOR

SEND 10¢ IN CHECK OR MONEY ORDER TO EDITORS and ENGINEERS, Ltd. BOX 589A SANTA BARBARA, CALIF. Distributors under license E&E & FAYLOR, INC., N. J.

Concord

VEE-DX YAGIS

*Less Than
Manufacturers' Cost!*

It may sound like bragging... but, we've made the most sensational Antenna buy of the decade, and we're passing the savings on to you. Here is an assortment of the finest VEE-DX 4 and 8 element all aluminum yagis that are priced in many cases at less than manufacturer's cost. We don't have a full selection of all channels in all types, so order early and assure yourself of an adequate supply of yagis at give-away prices.

<p>4 Element All-Aluminum Yagis</p> <p>Channel 7, 8, 9 List \$8.50</p> <p>\$1.98 EACH \$1.75 Lots of 3</p>	<p>8 Element Vee-DX Long John Yagis</p> <p>Channel 5 List \$25.80</p> <p>\$7.95 EACH \$7.50 Lots of 3</p> <p>Channel 9, 10, 13 \$4.50 ea. \$4.15 Lots of 3</p>
----------------------------------------------------------------------------------------------------------------------------------	------------------------------------------------------------------------------------------------------------------------------------------------------------------------------------------

FREE! NEW 1954 CATALOG!

A complete, comprehensive listing of all your electronic requirements. Buried with SPECIAL VALUES

Dept N7
CONCORD RADIO MINIMUM ORDER \$5.00
 20% deposit with C.O.D.
 Send new 1954 CONCORD CATALOG!

NAME _____
 ADDRESS _____
 CITY _____ ZONE _____ STATE _____

**CONCORD RADIO • 53 VESEY ST.
NEW YORK 7, N. Y. • Dlgby 9-1132**

light arm about 3/16" long, the free end of which holds a sapphire or diamond stylus.

This item is being handled through electronic jobbers.

TAPE "CONSOLE"

A newly-designed extension loud-speaker, housed in a cabinet which converts the company's portable push-button tape recorder into a console, has been introduced by *Radio Corporation of America*, Camden, N. J.

The unit is finished in polished mahogany and has a compartment into which the tape recorder can be placed for use or storage. The bottom section of the cabinet contains the company's "accordion"-edge extended range speaker and matching baffle.

The cabinet measures 29" high, 21" wide, and 16" deep with a beveled, picture frame edging around the front. Most of the front is covered with brown grille cloth in a gold criss-cross pattern.

SPEAKER KIT

De Mar Products Company, P.O. Box 1449, Chicago 90, Illinois is now offering a speaker kit for service technicians and audiophiles.

The kit consists of two 6½-inch, extended-range speakers and an output transformer to match the set. The speakers have a frequency response from 50 to 12,000 cps.

"ULTRA-LINEAR" AMPLIFIER

Sonex, Inc., 245 Sanson St., Upper Darby, Pa. is offering a new power amplifier which uses the "Ultra-Linear" circuit in a Williamson arrangement and features the *Acrosound* output transformer designed expressly for this type of circuitry.

The amplifier has frequency response flat ± .5 db from 10 to 100,000 cps,

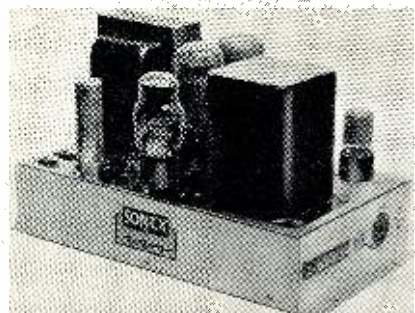

according to the company. It is rated at 25 watts and furnishes 20 watts at less than 1% intermodulation distortion. The amplifier is furnished with matched KT-66 tubes and matched resistors are used in the parts of the circuit that require balancing.

PHILCO SPEAKER

Philco Corporation of Philadelphia has announced a new 10" speaker which can be used with all single-speaker radio phonographs.

Offered as a separate unit, it can be operated as an auxiliary speaker in combination with the set speaker. A special three-way switch, included in the new kit, permits manual operation

of each speaker separately or together. In addition, there is a 30-foot

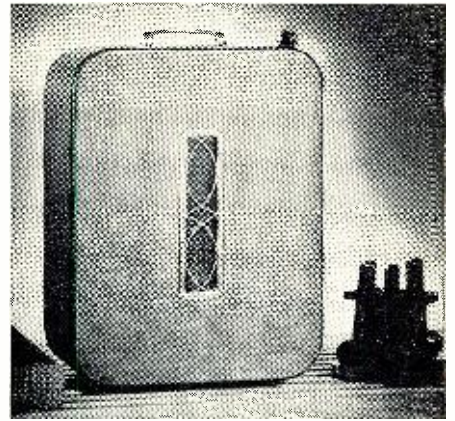

extension cord which makes the new unit flexible for use almost anywhere within the home as well as outdoors.

The kit is being marketed through the company's regular distributors.

NEW PICKUP ARM

Pickering & Company, Oceanside, Long Island, N. Y. has developed a new pickup arm for manual turntables, the Model 190D.

A re-engineered version of the Model 190, the new unit requires less mounting space while retaining the low vertical mass, static and dynamic balance, lack of arm resonance, and low friction of the original design.

The arm requires a 17"x17" motor board for mounting.

NEW E-V SPEAKERS

Electro-Voice, Inc., Buchanan, Michigan has added two new concentric-type 12" and 15" triaxial, three-way speakers to its line.

The new units combine the company's "Super-Sonax" very high frequency driver, "Radax," treble propagator, and large bass cone into one compact, concentric assembly.

Response is 30 to 15,000 cps in the company's "Regency" or "Aristocrat" enclosures. A full half-section, *m*-derived crossover network minimizes distortion products. The 12" unit is the Model 12TRX while the 15" unit is the Model 15TRX. Bulletin No. 204, giving full details, is available on request.

REGENCY AMPLIFIER

The *Regency Division* of *I.D.E.A.*, 7900 Pendleton Pike, Indianapolis 26, Ind. has added a moderately-priced unit to its audio amplifier line.

The Model HF-150 includes a preamplifier and power supply. It incorporates five controls for bass, treble, loudness, level control and record compensation, and input selection. It has a rated output of 12 watts and a frequency response of 20 to 40,000 cps ± ½ db. It is finished in gold-anodized aluminum.

STROMBERG SPEAKER

The Sound Equipment Division of *Stromberg-Carlson Company*, Rochester 3, N. Y. is offering a new 8" cone-type speaker, the Model RF-460.

20 TONS OF UNUSED ARMY SURPLUS RADIO GEAR CHEAP!

- #67—TELEGRAPH KEY, mounted on bakelite base $\frac{1}{4}$ " x $4\frac{3}{4}$ " x 3". Fully adjustable. Contacts of high grade tungsten.90c ea.
- #68—FILAMENT TRANSFORMER: Input 120V 60 cycles, 6 Volt output tapped at 2 & 4 volts. 10 amp. \$2.00 ea.
- #69—TERMINAL BLOCK, 3"x6", Western Elec., 60 terminals.50c ea.
- #70—ROTARY SWITCHES: Your choice of two, three, or ten gang.15c ea.
- #71—TRANSMITTER FILTER CHOKE, 3 Hys at 320 MA. \$1.50 ea.
- #72—KA-37 TELETYPE RECTIFIER, Input 110 AC, Output 130V DC, 1 amp. . . . \$5.00 ea.
- #73—OUTPUT TRANSFORMER AND LOW PASS FILTER, Pri. 10,000 ohms. Sec: 4 ohms, pass freq. from 410 cycles to 2000 cycles. . . . \$1.50 ea.
- #74—SELENIUM RECTIFIER, 40V, 1 amp output, full wave. \$1.00 ea.
- #75—LIP OR THROAT MIKE.25c ea.
- #76—ANTENNA ROTATOR, hand drive. Two 25' flexible drive shafts, all contained in 14" x 11" x 12" chest. \$6.00 set
- #77—ANTENNA WIRE, copper, insulated, 100 ft rolls, snap hook and ball fittings attached.75c roll
- #78—GRAB BAG ASSORTMENT, odds & ends of resistors, condensers, etc. five pounds. . \$1.00

ALL PRICES F.O.B. MEMPHIS, TENN.
Do not remit more than complete purchase price. Pay shipping charges on receipt of goods. 25% deposit on all C.O.D.'s please. Money-back guarantee.

ARMY SURPLUS OUTLET
91 North Second St. Memphis 3, Tenn.

IT IMPROVES THE PICTURE



list \$750

T-V CLARIFIER

Removes annoying signals that cause picture distortion in TV sets due to FM, amateurs, shortwave, diathermy, ignition and adjacent channels. Ghosts, lines, herringbone patterns, tears and wavy effects are eliminated or reduced simply by turning the two control knobs on this new type interference eliminator.

- No technical knowledge needed
- Traps unwanted signals
- Fastens to screws on back of set
- Easy to tune. Stable
- Small, mechanically rugged
- Necessary with every TV installation

PRECISION ELECTRONICS, INC.
9101-Rv King St., Franklin Park, Ill.
Please rush Free Bulletin on T-V Clarifier

Name _____
Address _____
City _____ Zone _____ State _____

July, 1954

Frequency response is from 50 to 13,000 cps, power handling capacity is 10 watts, impedance is 8 ohms, and flux density is 13,000 gauss. The speaker pan is fine wrinkle, silver-gray over cadmium plate while the magnetic structure is cardinal red. It can be used in applications where the speaker must fit into wall or ceiling enclosures, portable speaker cases, bookshelves, etc.

TAPE SPLICER
Tech Laboratories, Inc., 14 E. Edsall, Palisades Park, N. J. now has available a small model recording tape splicer, the "Editall, Jr."

This model was designed for use with home recorders as well as with portable professional equipment where weight and compactness are important. The block is made of duraluminum. It has no clips or mechanical parts to get out of order.

V.T.V.M. FOR AUDIO
Freed Transformer Company, Inc., 1715 Weirfield St., Brooklyn 27, N. Y. is offering its Model 1060 high-impedance v.t.v.m. which is especially suited to tuned circuit measurements at audio and ultrasonic frequencies.

Input impedance is 50 megohms in parallel with 25 μ fd. capacity. Accuracy is 2 per-cent on all ranges with full-wave average reading meter calibrated in r.m.s. Frequency coverage is from 10 cps to 30 kc. The meter also includes five voltage ranges. The 4" meter is suppressed zero protected against overload.

END-TABLE CABINET
Components Corporation, Denville, N. J. has announced an end-table cabinet for use with its professional model, three-speed turntable. The cabinet also provides space for an amplifier and record storage in addition to the turntable.

A roll top allows the record to be covered during playing. A fixed top

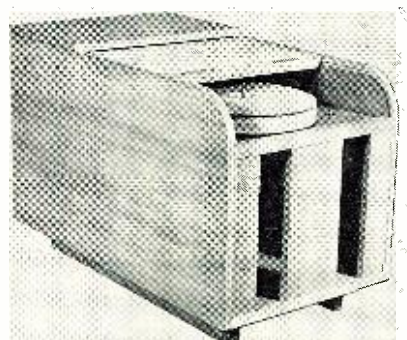

section at the rear provides room for a lamp and other accessories. It is available in either blonde or mahogany finishes, with or without the turntable.

STEPHENS CABINET
Stephens Manufacturing Corporation, 8538 Warner Drive, Culver City, Cal. is marketing a new type of speaker cabinet, the "Cavalcade."
Designed to produce full volume, the cabinet permits direct radiation



DICTATE REPORTS ACCURATELY-PROMPTLY!

make your car, boat or plane a "rolling office" WITH **ATR** INVERTERS



for changing your storage battery current to A. C.
Household ELECTRICITY Anywhere in your own car!

Plugs into Cigarette Lighter Receptacle on Dash

\$2250 AND UP
LIST PRICE



ATR INVERTERS . . .
especially designed for operating standard 110 volt A. C. . . .

- TAPE RECORDER
- WIRE RECORDERS
- DICTATING MACHINES
- ELECTRIC RAZORS

See your jobber or write factory today for complete information

ATR **AMERICAN TELEVISION & RADIO CO.**
Quality Products Since 1931
SAINT PAUL 1, MINNESOTA—U. S. A.

121

from the loudspeaker and employs the company's full-expanding dual exponential horn for rear horn loading.

Available in either blonde or mahogany finish, the cabinet is of modern design.

CORNER HORN

Product Development & Research, 2365 Le Forge Road, Ypsilanti, Mich. has developed a new corner horn featuring vertical design for greater utilization of wall surfaces.

Designed for a 12" speaker, with additional space for a tweeter, this ex-

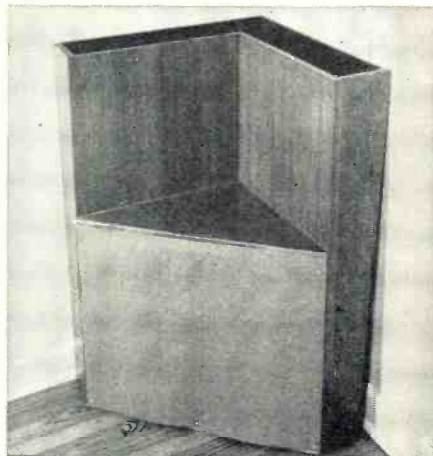

ponential horn has a top opening to take advantage of unobstructed wall space. The horn is 36 inches high, 24 inches wide with a triangular shelf 14 inches below the top formed by the "V" in the design. Back surfaces are slanted at the bottom to clear molding and quarter round. It is available in assembled or kit form.

5-WATT AMPLIFIER

Electronic Crafts Co., 74 Cortlandt St., New York, N. Y. is now marketing a 5-watt a.c. amplifier with built-in preamp for use with reluctance or crystal type pickups. The small, compact unit is designed for paging systems, intercoms, record players, or other sound systems.

The Model RL-5 uses three tubes and features a power outlet for a motor, a two-connection terminal strip for a 3.2 ohm speaker, and a built-in output transformer.

ULTRASONIC SPEAKER

Ultrasonic Corporation, 640 Memorial Drive, Cambridge 39, Mass. has announced a new low-cost, compact speaker, the U-26.

The new 1/2 cubic foot U-26 provides high acoustic efficiency with only 2 watts. The U-26 is designed for 4 ohm speaker while the U26A is for 16 ohms.

The cabinet, available in either blonde or mahogany finishes, measures 13" wide, 19" deep, and 10 1/4" high.

CUSTOM CONVERTER

Carter Motor Company, 2641 N. Maplewood Ave., Chicago 47, Ill. has introduced a custom converter for hi-fi installations.

This new 500 watt unit, #DR1025-C5PX, is designed to deliver 125 volts

MEN! THIS IS IT!

Nothing like these "Q.T." Cartoon Booklets, ever!
REAL COLLECTOR'S ITEMS!



1. Maggie and Diggs
2. Toots and Jasper
3. Tillie the Soiler
4. Lord Pushbottom & Emma
5. Villain & Little Nell and others.

ACT NOW!

FREE CATALOG OF TITILLATING NOVELTIES WITH ORDER

ALL VEST POCKET SIZE — 10 FOR \$1.00
Box 8516, Dept. 726
Hollywood 46, Calif.

Q.T. SALES

CRYSTALS!

COMPLETE SET—80 CRYSTALS

Ranging from 370-516 Kc., 54th Harmonic. INCLUD-
ING 500 Kc. & 455 Kc. crystals. Per set **\$6.95**
Only.....

COMPLETE SET—120 CRYSTALS

Ranging from 370-540 Kc., 72nd Harmonic. INCLUD-
ING 500 Kc. & 455 Kc. crystals. Per set **\$9.95**
Only.....

200 KC. CRYSTAL..... Ea. \$1.75

500 KC. CRYSTAL..... Ea. .75

GENERATOR: 12 V. 35 A. Used cond. Ea. \$3.95

24 V. TRANSFORMER, Dri. 110 @ 2 amps. Ea. \$1.95

NEW..... \$1.95

EXTRA! See Our Ad in April '54 Radio News. Loads of Hot Buys. No Change in Prices!

400 MICA CAPACITORS, Assorted, Mounted 10 to a strip. All 400..... \$1.95

ARW-2 REMOTE CONTROL RECEIVER, New, \$27.50

All merchandise sold as is. Write for quantity discounts! Items subject to prior sale. Send for FREE Catalogue!

J. J. GLASS ELECTRONICS CO.

1615 S. MAIN ST. LOS ANGELES 15, CALIF.

It's P.A.R.T.S. for PARTS!

J-47 TELEGRAPH KEY, New..... \$1.50

CARTER GENEMOTOR

This is the deal that usually sells for \$85.00!
Input, 5.5 VDC 12 amp. Output, 350 V. 150
mils. Mounted on filtered base with starting
relay. NO HUM! F.R. for marine, control,
aircraft, etc. Perf. cond. **\$17.95**

RESISTOR ASSORTMENT: New, guaranteed! Approx. 140 per lb. Real, top value..... \$1.50 per lb.

MICA CONDENSERS ASSORTMENT: Unused! Approx. 110 per lb. A great buy!..... \$1.50 per lb.

BC-1206 BEACON RECEIVER (The Lazy Q'er): 200-400 KC. Volume control, RF gain control, 24-28 VD. Needs no power supply. Less tubes. **\$7.50**

NEW..... **\$7.50** USED..... **\$4.25**

All shipments F.O.B. Burbank, Cal. 20% deposit re-

quired. VISIT OUR NEW EASY-REACH QUARTERS!

Ask for FREE LIST giving VT & commercial equivalent tube numbers.

P-A-R-T-S, INC.

2005-15 Empire Ave., Burbank, Calif.

PHONES: Victoria 9-2834 THORNTON 2-5349

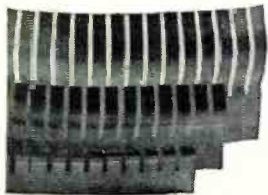

FINGER STOCK

Electrical Weather-Stripping by Eimac — Now Available!

Silver-plated, spring alloy, pre-formed finger stock especially suited for electrical "weather-stripping" for TVI-proofing cabinet access doors, etc. Also ideal for making coaxially constructed tube connections and many other uses. Available in 17/32", 31/32", and 1 7/8" widths.

Write for new Eimac Catalogue Summary showing Eimac tubes and other accessories.

Eimac

EITEL - McCULLOUGH, INC.
San Bruno, California

MOVIES ON APPROVAL



Most entertaining 8MM DANCE FILMS for home movie shows. Write today and we'll send you a 50-ft. 8MM FILM—POSTPAID—ON APPROVAL. (Return film and 25c within 5 days without obligation, if it's not worth more than the \$1.50 we ask). BONICA NEWSREEL CLUB, 6516-RT Selma Avenue, Hollywood 28, California.

TELEVISION

PREPARE FOR A GOOD JOB!
BROADCAST ENGINEER
COMMERCIAL OPERATOR (CODE)
RADIO SERVICING

Television Servicing

(Approved for Veterans)
SEND FOR FREE LITERATURE
BALTIMORE TECHNICAL INSTITUTE
1425 EUTAW PLACE, BALT., 17, MD.

RADIO & TELEVISION NEWS

a.c. with 120 volts d.c. input and a load of only 50 watts. Due to the regulation of the converter, the voltage would only drop to about 105 volts with 110 volts d.c. input and full 250 watt load. These a.c. limits coincide with equipment ratings.

Frequency control with frequency meter is included allowing the operator to adjust to exactly 60 cycles for record players and tape recorders. A filter is available for noise-free radio reception.

BINAURAL TUNER

Browning Laboratories, Inc. Winchester, Mass. is in production on a new tuner designed specifically for binaural reception which provides simultaneous reception of AM and FM broadcasts.

The Model RJ48 also provides either AM or FM high-fidelity reception or independent reception of two different programs with speakers located in different rooms. Provision is made for the use of tape recorders. Detailed information is available from the manufacturer.

TUNER-AMPLIFIER

Freed Electronics and Controls Corp., 200 Hudson St., New York 13, N. Y. has re-entered the audio field with the release of its P-717 AM-FM tuner and amplifier.

Marketed under the *Freed-Eisemann* tradename, the new chassis provides a.f.c. of the FM circuit, terminated in a Foster-Seely limiter-discriminator. Multi-purpose tubes are used to give 15-tube performance. Response of the unit is 20 to 20,000 cps \pm 1 db at full output. Audio output is 10 watts at less than 1.5% distortion. A preamp for variable reluctance phono pickups, treble and bass controls, full record compensation, and a jack for a tape recorder are also included.

TURNER LAPPEL MIKE

The Turner Company, 909 17th St., N.E., Cedar Rapids, Iowa is now offering a new and improved lapel microphone, the L-100.

This new crystal unit weighs only 1

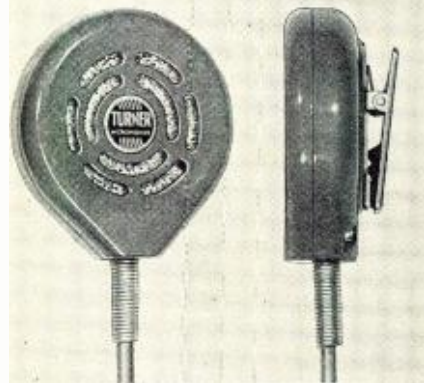

ounce without the cable. An adjustable, rubber-padded clip permits the microphone to be clipped anywhere. Frequency response is 50 to 10,000 cps,

July, 1954

N.J.R.T. TUBES 70% to 90% OFF LIST

GUARANTEE

ALL NJRT TUBES ARE BRAND NEW AND FULLY GUARANTEED FOR ONE YEAR

Type	Price	Type	Price	Type	Price	Type	Price	Type	Price
1A7GT	.45	6AL5	.39	6BZ7	.95	6W4GT	.45	12V6GT	.50
1B3GT	.67	6AQ5	.39	6C4	.39	6W6GT	.45	12X4	.35
1H5GT	.38	6AQ6	.36	6CB6	.45	6X4	.39	19BG6G	1.15
1L4	.50	6AQ7	.68	6CD6G	1.15	6X5GT	.35	19T8	.75
1N5GT	.62	6AR5	.45	6F6	.45	7E6	.40	25BQ6GT	.75
1R5	.48	6AS5	.50	6H6	.53	7X6	.58	25L6GT	.45
1S5	.40	6AT6	.39	6J5	.40	7L7	.77	25W4GT	.45
1T4	.48	6AU4GT	.70	6J6	.50	12AL5	.40	35A5	.49
1U4	.48	6AU5	.82	6K6GT	.39	12AT6	.35	35B5	.38
1U5	.40	6AU6	.45	6L6	.62	12AT7	.65	35C5	.38
1X2	.65	6AV6	.39	6R7	.49	12AU6	.38	35L6GT	.45
3A4	.45	6AX4GT	.59	6S4	.39	12AU7	.55	35W4	.45
3Q4	.48	6BA6	.40	6S8GT	.51	12AV6	.50	35Z5GT	.45
3Q5GT	.48	6BA7	.57	6SA7GT	.41	12AV7	.60	45	.53
354	.48	6BC5	.49	6SB7Y	.76	12AX4GT	.55	50B5	.41
3V4	.50	6BD6	.45	6SC7	.59	12AX7	.55	50C5	.41
5U4G	.55	6BE6	.39	6SO7GT	.39	12BA6	.40	50L6GT	.59
5Y3GT	.39	6BF5	.55	6SK7GT	.39	12BA7	.57	70L7GT	1.07
5Y4G	.39	6BG6G	1.20	6SL7GT	.49	12BE6	.41	76	.42
6AB4	.42	6BH6	.45	6SN7GT	.55	12BH7	.65	81	1.25
6AF4	.92	6BJ6	.41	6SO7GT	.37	12BY7	.65	117L7GT	1.19
6AF6	.75	6BK7	.89	6T8	.75	12BZ7	.65	117P7GT	1.39
6AG5	.49	6BL7GT	.65	6U7	.56	12SL7GT	.49	117Z3	.39
6AH4	.67	6BQ6GT	.77	6U8	.59	12S7GT	.50	117Z3	.39
6AK5	.59	6BQ7A	.92	6V6GT	.45	12SR7met	.55	807	1.25

T.V. PIX TUBE BRIGHTENER

\$1.39

HI-PO TV RECTIFIER TUBES LAST LONGER

Makes Picture brighter, larger

HI-PO 567 TO REPLACE 5U4G **\$1.39** HI-PO 6578 TO REPLACE 6SN7GT **\$1.95**

PEE-WEE "HIDE-A-WAY" ANTENNA

no bigger than a half dollar.....

79¢

FREE FIVE 1L4 TUBES INDIVIDUALLY CARTONED LIST \$11.25 WITH EVERY ORDER OF \$25.00 OR MORE.

Many 7 volt types not listed. All tubes individually boxed. For orders under \$10 add \$1 handling charge. Tubes offered subject to prior sale. Prices subject to change. All orders shipped F.O.B. 25% deposit on c.o.d. shipments.

SEND FOR FREE TUBE LISTING.



NEW JERSEY TELEVISION SUPPLY CO.

Sole Distributor of NJRT Tubes

906B WESTFIELD AVE., ELIZABETH, N. J. EL. 3-6166

In DETROIT it's AARON ELECTRONICS

6025 Mt. Elliott, Detroit 11, Michigan

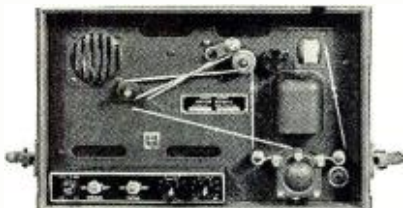

TC-34-A CODE KEYS—115/230 V 50-60 cycle—Automatic unit reproduces code practice signals recorded on paper tape. This unit will provide code signals to one or more persons by use of self contained speaker. Keying oscillator for use with a ham key. Comes in portable carrying case—complete with tubes, photocell & operating manual. Size: 10 9/16 x 10 1/2 x 15 13/16. Shipping wt. 45 lbs. BRAND-NEW in original carton... **\$24.95**

TC-10 CODE KEYS—similar in operation to TC-34-A but with higher audio out (2-6L6) to 4, 8, 15 ohm spk., not supplied. Fine for P.A. systems. Size: 11 x 24 x 18 1/2". Wt. 65 lbs.—with tubes and photocell. (See April ad for picture.) Used... **\$19.95** Also new in original carton... **\$29.95**

CODE PRACTICE & TRAINING TAPES—for use with the TC-34 & TC-10 keys. Inked on 18 mm paper on 400 ft. reel. Complete set of 15 reels. New in wood carrying case... **\$12.95**

INDIVIDUAL TAPES for the following lessons—21, 22, 23, 24, 25, 26, 27, 28, 29, 30, 31, 32. New in metal containers... ea. **\$1.25**

SUPREME METER #5918—Scaled for Volt-Ohm-Output—40 ohm movement—2 3/4" round body—4 x 4 1/4" square face—Out of Model #82 Test Set—2.03 lbs.—New. Boxed... **\$6.95**

0-200 DC UA METER—accuracy 2%—sensitivity 900 ohm per 1 V. D'Arsonval movement—40 scale divisions—2 3/4" round body—4 x 4 3/4" x 1 1/2". Rectangular flange. New... **\$6.95**

TRIUMPH SWITCH ASSY—Model G-30-27—5 pole—8 pos.—compl. wired w/all volt multipliers & current shunt resistors—w/copper oxide rectifier, knob, mfg. hdw. New... **\$2.95**

CERAMIC CHANGE OVER RELAY—DPDT—1 each—2177—Cont. rating 115 V 6 amp. Single wound coil 220 VAC 60 cycle. 25 ma—3000 ohm DC rest.—fast acting. New... **\$1.95**

TECH. MANUAL for BC-221 Freq. Meter. New. **\$1.25**

115 VAC 60 cycle BLOWER—1525 rpm. Type L—Model #171—approx. 100 cu. ft. dis. 3/4" intake—2" outlet. Motor size 3 1/4 x 3"—has mounting bracket with detachable heating element... **\$8.95** less heating element... **\$8.95**

CARDWELL 7 GANG TUNING CONDS.—Type CA-235—30 to 1 dual gear ratio—out of BC-223 xmt. New. **\$2.95 ea.**

PHONE SPEAKER BOX—contains 2 dyn. spk. 24 V Haydon timer motor (see Feb. ad for picture & compl. description). **\$1.95 ea.** ... **\$3.50**

25¢ WITH ORDER—BAL. INCL. POSTAGE C.O.D. MICHIGAN RESIDENTS ADD 3% SALES TAX.

AUDELS TV-RADIO SERVICE LIBRARY

HERE IS LATE INFORMATION IN A HANDY FORM FOR RADIO AND TELEVISION REPAIRMEN, SERVICEMEN AND STUDENTS

2 VOLS. 6 COMPLETE \$11.00 PAY ONLY \$1.00.

AUDELS T.V.-RADIO SERVICE LIBRARY—Highly Endorsed—1001 Facts—Over 1552 Pages—625 Illustrations, Diagrams of Parts, Presents Important Subjects of Modern Radio, Television, Industrial Electronics, F.M., Public Address Systems, Auto, Marine & Aircraft Radio, Phonograph Pick-Ups, etc.

IT PAYS TO KNOW!

The Basic Principles—Construction—Installation—Operation—Repairs—Trouble Shooting. Shows How to get Sharp, Clear T.V. Pictures. Install Aerials—How to Test, Explains Color Systems, Methods of Conversion, Terms, etc. Includes Ultra High Frequency (U.H.F.)—Valuable for Quick Ready Reference & Home Study. Tells How to Solve T.V. & Radio Troubles—Answers Your Questions.

Get this Information for Yourself. 7 DAY TEST—ASK TO SEE IT!

MAIL ORDER

AUDEL, Publishers, 49 W. 23 St., N.Y. 10, N.Y. Mail AUDELS T.V. RADIO SERVICE LIBRARY 2 Vols. \$6 on 7 days free trial. If O. K. I will remit \$1 in 7 days and \$1 monthly until \$6 is paid. Otherwise I will return them.

Name _____
 Address _____
 Occupation _____
 Employed by _____

FREE!
32 PAGES OF
**EXCITING
SUMMER
SAVINGS**

RADIO AND TV MEN!
DON'T MISS 100's OF BARGAINS!
Parts, tools, equipment... plus such extra profit-makers as Window Fans, Air Conditioners, Portable Radios, Public Address Systems, Amplifiers, etc.

JUST ONE OF THE MANY BIG VALUES IN THIS 8-A FLYER!

TEN ASSORTED TUBULAR ELECTROLYTICS

REG. \$10.00
NET VALUE!
\$2.19

Consists of Cornell-Dubilier single, dual and triple section tubular type electrolytics in popular capacities and voltages. Obtained from big name TV manufacturers overstock. All brand new and guaranteed. Regular net cost approximately \$10.00.
No. 18B64. 10 ASSORTED.....\$2.19

BURSTEIN-APPLEBEE CO.
1012-14 McGee St., Kansas City 6, Mo.
 Send Free Summer Flyer.
 Send me.....18B64. S.....enclosed

Name.....
Address.....
City..... State.....
Include postage for parcel post shipments.

New **TUBES** Standard Brands
Guaranteed

**PRICES SLASHED
FAR BELOW WHOLESALE!**
Standard brands only! One of largest stocks in U.S. We sell-buy-trade. WRITE FOR FREE CATALOG JUST OFF PRESSES.

1A3	.70	6J8G	.80	45Z5	.69
1A4	1.00	6K7	.75	50L6GT	.99
1A7	.85	6L6	1.50	83	.89
1C5	.85	6L7	.95	0A2	.95
1C6	1.00	6N7	.95	0B2	.99
1C7	1.00	6S4	.60	1D21	3.50
1C21	1.00	6S47	.80	2C2	3.95
1LA4	.90	6S7	.95	2D21	1.15
1L6	.90	6S7F	.90	2E26	3.25
1LN5	.90	6S7T	1.00	2X2	2.00
1NSGT	.65	6S77	.75	3F77	1.95
1R4	.90	6S7H	.75	3G11	1.95
1K2A	.90	6S7J	.60	3HP7	2.95
3D6	.90	6S7K	.60	5A71	3.95
3Q4	.60	6S17GT	.85	5BP4	3.25
3G5GT	.80	6S77GT	.85	5P77	1.95
3S4	.85	6S07	.55	12AY7	1.50
5T4	1.40	6SR7	.70	114B	.49
5U4G	1.70	6S57	.90	304TL	6.95
5V4	1.00	6S77	.65	701A	4.50
5X4	.65	6T8	.75	807	1.50
5Y3GT	.65	6U8	1.00	809	2.90
5Y4G	.55	6V6GT	.70	811A	3.49
5A7	1.00	6W4GT	.60	829	6.50
5AG5	.75	6X4	.60	829	6.50
5AC7	.90	6Y6G	.85	830B	1.95
5AG7	1.20	7A67	.85	866A	1.30
5AK5	.75	7C4	.90	872A	1.95
5AL5	.55	7C7	.90	878	2.00
5AQ5	.65	7J7	1.00	922	1.30
5AQ6	.75	7N7	.90	923	1.30
5AT6	.45	12A6	.85	931A	4.50
5AU6	.70	12AT7	.95	935	5.50
5AV5GT	1.10	12AU7	.95	954	.33
5B4G	1.00	12AX4GT	.85	955	.49
5B6G	1.60	12C8	.80	956	.49
5B86	.70	12H6	.62	957	.49
5B86	.70	12J5	.60	958A	.69
6C4	.60	12K8	.80	959	1.50
6J4	4.50	12R8	.59	1619	.30
6I6	.70	12SC7	.89	1625	.35
6C6	.95	12SF7	.99	2050	1.30
6D6	.85	12SH7	.70	2051	.95
6F6	1.10	12SL7GT	.92	5654	1.50
6F7	1.00	12SN7GT	.80	5814	1.50
6FRG	1.00	12S7	.65	9001	1.10
6GGG	.85	12SR7	.49	9002	.85
6NG	.65	25L6GT	.69	9003	1.25
6J5					

Thousands of other types of Transmitting and Receiving Tubes. Prices subject to change without notice. Californians add sales tax. Add postage to order. Minimum order \$5.00.

SPECIAL! VACUUM CAPACITORS!

6 mmfd. 30KV	10.00	50 mmfd. 40KV	14.50
50 mmfd. 20KV	10.00	100 mmfd. 10KV	12.00
50 mmfd. 32KV	12.50	100 mmfd. 20KV	14.00

Jsh
SALES CO.
Dept. R-F
7552 Melrose Ave.
Los Angeles 46,
California

output level is 52 db below 1 volt/dyne/sq. cm, pickup pattern is essentially non-directional. The unit is supplied with a 20-foot attached single-conductor, shielded cable. The case is light-grey plastic.

A similar unit, but without the clip and with a 7 foot cable, is being offered as the Model 100.

NEW "FOLD-A-FLEX"

Angle Genesee Corporation, 107 Norris Drive, Rochester 10, N.Y. is now in production on the Model 33 "Fold-a-flex" speaker enclosure.

The new unit permits compensation for every speaker system, every room, and every acoustical condition. By means of a simple adjustment, it be-

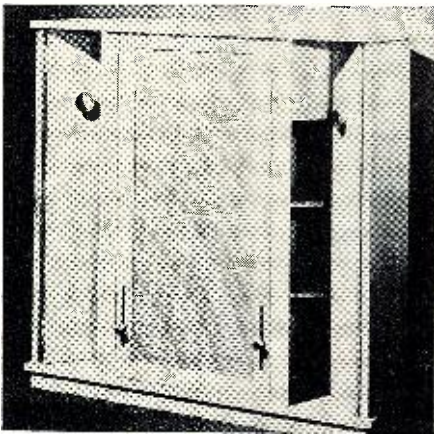

comes a folded horn, infinite baffle, or bass reflex enclosure.

Provision is made for either a 12" or 15" speaker. A sealed compartment at the top is provided for tweeters and mid-range speakers with space available for a crossover network. It can be used with a single speaker originally and later expanded to a 2- or 3-way system.

Standard finishes for the Model 33 are hand-rubbed blonde oak and mahogany. Custom finishes are also available. Dept. RN will supply full details on request.

SOUND PACKAGE

Asco Sound Corporation, 115 West 45th Street, New York, N.Y. is now offering a new sound package which has been designated as "High-Fi in Miniature."

The system comprises the new Brociner "printed circuit" Mark 12 amplifier and an imported Lenco record player.

The new unit can be attached to any quality speaker system. Compact in design, the unit is an integration of the Brociner amplifier which includes all of the controls ordinarily found only on expensive units and the Lenco record player, of Swiss precision make, which is designed to play 33, 45, and 78 rpm records.

Set within a typical phonograph enclosure, the over-all unit measures 9" high, 16" wide, and 13 1/4" deep. It is currently available in ebony, black lacquer, cherry mahogany, and natural birch finishes.

Magnetic Recording

(Continued from page 59)

company failed and the stock became worthless. A Danish company was formed in 1909, and dissolved in 1916 without having manufactured a single machine. For some years after the "Telegraphone's" commercial failures, magnetic recording disappeared from the public eye and ear.

In the middle twenties a man with a wire recorder and a remarkable ability at persuasion obtained backing from German financiers and formed a company known as the *Telegraphic-Patent-Syndikat*. He was Kurt Stille and the company's purpose was that of selling licenses to manufacture magnetic-recording equipment. Some say it was a modified American "Telegraphone." By dramatic salesmanship he succeeded in selling them to companies who actually went ahead and did manufacture the machine.

About 1930 a motion picture promoter named Blattner bought the right to manufacture Stille's machine for entertainment purposes. Blattner, however, used a steel tape. He named his machine the "Blattnerphone." It was used quite extensively by the *British Broadcasting Company*. It is believed that the "Blattnerphone" was the first magnetic tape machine to be used in the Western Hemisphere when the *Canadian Broadcasting Corporation* installed it in their Montreal offices for delayed broadcasts.

The "Blattnerphone" used a steel tape about 3/1000th of an inch thick, approximately a quarter inch wide, and required operating speeds of 3 to 6 feet-per-second. It was discarded eventually for technical and economic reasons. It had only slightly better frequency range than the original Poulsen machine, noise was high, the reels were unwieldy and quite expensive.

Kurt Stille sold a license for the manufacture of dictating and telephone recording equipment to a Karl Bauer who formed the *Echophone Company*. Its product was called the "Dailygraph." It was the first magnetic wire recorder to use a magazine instead of separate reels, considerably simplifying operation. A number of different models were manufactured, the least expensive of which cost approximately \$600.00. The "Dailygraph" had good acceptance. In 1932, Bauer sold the *Echophone Company* to the *International Telephone and Telegraph Company*. It was then resold to the *C. Lorenz Company* in Germany who completely redesigned and marketed the machine under the name of "Textophone."

This new recorder was placed on the market in 1933, about the time Hitler came to power. The Gestapo bought the "Textophone" in large quantities and gave magnetic recording a big commercial boost. The *Lorenz Company* also marketed a magnetic steel tape recorder which they called the "Stahltonmaschine," and in

SUPER TV BARGAINS

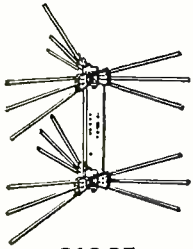

Fringe Master MOTORLESS DIRECTRONIC

- NO GHOSTS
- NO INTERFERENCE
- ELECTRONICALLY BEAMED
- NO MOTORS NEEDED

Model AX-570. 18-element, stacked array provides sparkling reception in city or fringe—all channels in all directions. Serviceman's kit provides 18 hi-tensil aluminum elements 6-position Directronic Beam Selector. 1 set matched stacking bars, 75' TRI-X Cable, universal U-Clamp. Complete Kit . . . \$16.95

\$16.95

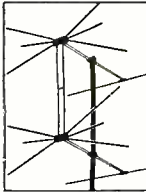

Tremendous Conical Bargain 2-Bay 16-Element Array

\$4.99 EACH IN LOTS OF 3

With Hi-Band Adapters. Sturdy 3/4" Elements.

SINGLE LOTS . . . \$5.30 EACH

This conical 2-bay 16-element array provides ultra-fine fringe reception. Includes sixteen 3/8 inch airplane type aluminum elements, including hi-band adapters for greater gain on the high channels and is complete with one pair of stacking bars to each

array. These are packed in cartons of three 16-element arrays per carton, with tie rods, at \$14.95 per carton. Single 16-element arrays, separately boxed—

your cost . . . \$5.30 each

3 Two-Bay Arrays per carton without Tie Rods . . . \$3.50 carton

4 Bay Ultra-Fringe Stacking Assembly for Above-Model 4B . . . \$1.95 set



UHF CORNER REFLECTOR

ONLY \$2.99 EACH IN SINGLE LOTS

LOTS OF 6 \$3.50 EACH

This hi-gain UHF Corner Reflector can only be offered you at this low, low price for a short time. 8 to 11 db gain across UHF band. Order Model F-6.

NEW SPRING-SUMMER CATALOG AVAILABLE

ALL PRICES F.O.B. CLEVELAND, OHIO. Do not remit more than complete purchase price. Pay shipping charges on receipt of goods. 25% deposit on all C.O.D. orders, please. Money-back guarantee.

National Electronics OF CLEVELAND

THE HOUSE OF TV VALUES
106 Delco Building Cleveland 3, Ohio

ATLAS RADIALS

FOR CHURCHES



FOR FACTORIES

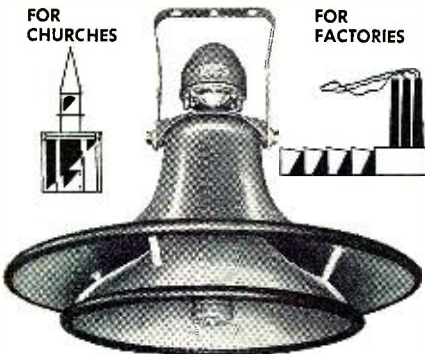

FOR TERMINALS



FOR CARNIVALS



With uniform 360° coverage, non-resonant construction, and 100% storm-proofing, ATLAS Radial Driver Unit Projectors often solve the most difficult sound problems—are excellent for reproduction of speech, chimes and music. For complete details on Radials and the famous ATLAS line of Public Address and Microphone Stand Equipment . . .

WRITE NOW for FREE Catalog 553



ATLAS SOUND CORP.

1446 39th St., Brooklyn 18, N. Y.
In Canada: Atlas Radio Corp., Ltd., Toronto, Ont.

1935 the German Broadcasting Company adopted it.

While all of these business exchanges and maneuvers were going on, another German, by the name of Pfeumer, developed the forerunner of the modern magnetic tape recorder. He conducted experiments with magnetic recording mediums consisting of paper or plastic tapes coated with powdered magnetic materials. His first efforts were somewhat crude and the results were a sandpaper-like roll of tape.

However, in 1931, several large research organizations, one of which was I. G. Farben, undertook the development of his idea. They designed and constructed a magnetic tape of paper with a very fine powdered coating and a recorder which could produce the best results yet obtained. They called it the "Magnetophone."

At its first demonstration in 1935 at the German Annual Radio Exposition in Berlin, the "Magnetophone" made a hit. The "hit" was due primarily to the astonishingly low cost of the "Magnetophone" magnetic recording tape which cost only 15 cents-per-minute as compared to \$1.00 per-minute for steel tapes. The new magnetic recording material was also less unwieldy. Very little information concerning the "Magnetophone" was available from that time until the end of World War II.

When the Allies entered Germany they discovered that the Nazis had continued to work on magnetic recording despite severe shortages of manpower and material. The equipment showed a remarkably high degree of development for both broadcast and military applications. Magnetic powder-coated tapes had been greatly improved and the "Magnetophone" had been redesigned to take fuller advantage of their capabilities.

American industry and research and development companies continued where the "Magnetophone" had left off, bringing magnetic recording tapes and equipment to their present low cost, long life, astonishing fidelity, and have so simplified their operation that the youngest child can, with brief instructions, make and play back his own instantaneous magnetic tape recordings.

-30-

J. R. Bauserman (right) director of the bureau of vehicles in the Virginia Division of Motor Vehicles, presents a special license plate for mobile W4RSB to Joseph A. Johnson, owner of the station while Vernon McCoy, another ham, checks gear.



Quality Features OF TUNG-SOL PICTURE TUBES

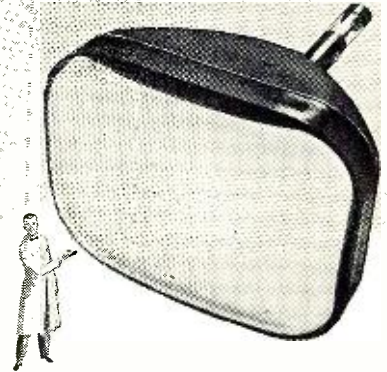

Gun made of best grade non-magnetic steel.

Glass head type assembly is stronger both mechanically and electrically—gives greater protection against electrical leakage.

Rolled edges in gun minimize corona.

Custom built stem with greater spacing between leads assures minimum leakage.

Low resistance of outside conductive coating minimizes radiation of horizontal oscillator sweep frequency.

Double cathode tab provides double protection against cathode circuit failure.

Selected screen composition resists burning (X pattern).

Rigid control of internal conductive coating provides utmost service reliability.

Designed for use with single or double field ion trap designs.

One-piece construction of parts assures better alignment.

Maximum dispersion of screen coating assures uniform screen distribution.

Tung-Sol makes All-Glass Sealed Beam Lamps, Miniature Lamps, Signal Flashers, Picture Tubes, Radio, TV and Special Purpose Electron Tubes and Semiconductor Products.

TUNG-SOL ELECTRIC INC., Newark 4, N. J. Sales Offices: Atlanta, Chicago, Columbus, Culver City (Los Angeles), Dallas, Denver, Detroit, Newark, Seattle.

TUNG-SOL®
RADIO AND TV TUBES



You Can Build A Reputation On Tung-Sol Quality

COMMAND GEAR IS HERE AND COLUMBIA'S GOT IT!

ARC-5 OR 274-N TRANSMITTERS

All Pre-tested and Guaranteed!

2.1-3 mcs. Brand New	\$19.95
3-4 mcs. With Tubes	24.50
4-5.3 mcs. With Tubes	8.95
5-6.7 mcs. With Tubes	8.95
7-9.1 With Tubes	13.95
T-23 ARC-5 VHF TRANSMITTER. For C.A.P. With Tubes 100-150 mc. Crystal Control	19.95

COMMAND TRANSMITTERS AS IS DO NOT SPECIFY FREQUENCIES \$1.95 Each

ARC-5 OR 274-N RECEIVERS

Equipped with Tuning Knobs

.19-55 kc.	\$19.95
1.5-3 mcs. Like New	22.50
3-6 mcs. Brand New	22.50
3-6 mcs. With Tubes	10.50
6-9.1 mcs. With Tubes	Used 7.95 New 22.50
6-9.1 mcs. Used. Less Tubes	5.95
BC-436 274-N Modulator, Less Dynamotor. Excel. Cond.	3.95

COMMAND RECEIVERS, AS IS, DO NOT SPECIFY FREQUENCIES \$3.95

Plus All Accessories Needed For Above. Conversion Data Available On Request.

NEW SIG. CORPS RELEASE

LATEST FIELD TELEPHONES: Made of Lite-Weight Aluminum, Waterproof, Long Range. Has Bell or Neon Indicator for Call Signal. Uses a Handset With P-1 Button. Easily converted to Terrible Phone Patch. Complete With Batteries

Brand New, Per Pair.....\$19.50
Each.....10.95
SCR-183 12 V. RECEIVER AND TRANSMITTER
Covers Marine as Well as Aircraft and Ham Bands With Proper Coil. Has 2 Coils, 2 Control Boxes, Tuning Head, Flex Cable, 12 Dynamos. PARTS ALONE WORTH \$25.35! Approx. 25 W Output. Plus Schematic.

NEW LOW PRICE.....\$12.95 ea.

PUT YOUR NAME ON OUR MAILING LIST FOR FREE PUBLICATIONS

MINIMUM ORDER \$3.00

All orders F.O.B. Los Angeles. 25% deposit required. All items subject to prior sale. Dealer Inquiries invited.

COLUMBIA ELECTRONIC SALES

2251-53 W. Washington Blvd., Los Angeles 18, Calif. Come in and visit our new, larger buyer's mart!

*Pat. Pending ONLY \$4.95 + Ppd. or C.O.D. + Chgs.

THE NEW TV DYNATRACER

- TRACES TV SIGNALS
- AID VOLTAGES
- LOCATES DEFECTIVE COMPONENTS
- REQUIRES NO ADDITIONAL EQUIPMENT

Ideal for trouble-shooting television sets in home or shop. Outperforms more expensive testers and pays for itself on the very first repair.

A "Must" for Every TV Technician

The "DYNATRACER" is a self-powered quality test instrument that traces TV signals through any Video, Sound, Sync, A.F.C. Horizontal or Vertical Sweep Circuit—isolates trouble to a stage or component. Traces voltages (50/500 V. AC/DC). Aids in locating open, shorted, intermittent or leaky (up to 20 MEGOHMS) condensers, resistors, coils, XFormers, etc.

Complete with Instruction Manual and Repair Guide

10 DAY MONEY-BACK GUARANTEE

FREE With each new order we'll include a unique "TV High Voltage Indicator" useful in your testing work.

Cut out advertisement . . . attach name and address with \$5.00 bill, check or money order and mail to

Century ELECTRONICS CO.
211-04 99th Ave., Dept. 215, Queens Village, N. Y.

RADIO ENGINEERING DEGREE IN 27 MONTHS

Radio engineering is a big field. There's room for you in it—if you're good. Get first-class training at Indiana Tech. Intensive, specialized course, including strong basis in mathematics and electrical engineering, advanced radio theory and design, television, electronics. Modern laboratories. Low rate. Also B.S. DEGREE IN 27 MONTHS in Aeronautical, Chemical, Civil, Electrical and Mechanical Engineering. G.I. Government approved. Enter September, December, March, June. You can earn part of your expenses right here in Fort Wayne while you are studying.

INDIANA TECHNICAL COLLEGE

974 E. Washington Blvd., Fort Wayne 2, Indiana

Please send me free information on B.S. Engineering Degree in 27 months as checked.

- Radio-Television Aeronautical
 Civil Mechanical Electrical

Name
Address

SAVE \$\$\$
THOUSANDS OF BARGAINS

Send Stamp for our

GIANT CATALOG

UNITED RADIO CO.

58A MARKET ST. NEWARK, N. J.

MANUFACTURERS' LITERATURE

The various listings presented in this section are for your convenience. The bulletins, unless otherwise indicated, are available to all our readers. For prompt attention write directly to the manufacturer for this literature.

RADIO RECEPTOR DATA

Radio Receptor Co., Inc., 251 W. 19th Street, New York 11, N. Y. now has available for free distribution two new publications.

Bulletin No. 177 is a comprehensive 24-page catalogue describing the company's "Seletron" selenium rectifiers. Fully illustrated with voltage curves, circuitry, tabular matter, and product applications, it devotes considerable space to an expanded tabulation of power rectifiers.

The second publication, Bulletin No. G-23, covers the company's line of germanium diodes and germanium transistors. The catalogue is illustrated with charts, voltage curves and diagrams, and product application data.

Either or both of the bulletins will be sent to engineers on request.

HI-FI EQUIPMENT

The Goody Audio Center, 235 W. 49th St., New York 19, N. Y. has published its first annual catalogue covering high-fidelity equipment.

The 88-page booklet, completely illustrated, lists the firm's entire selection of phono equipment, tuners, amplifiers, speakers, cabinets, and tape recorders. The booklet not only has a complete index but also lists items alphabetically by manufacturer within each major grouping.

OIL-FILLED CONDENSERS

Industrial Condenser Corp., Dept. RTN, 3243 N. California Ave., Chicago 18, Ill. has issued a four-page brochure on its line of tubular oil-filled condensers.

Catalogue 1134 pictures and describes the company's "G" and "H" series which cover a capacity range from .5 to 8 μ f.

FACILITIES BROCHURE

Barnes & Reinecke, Inc., 230 E. Ohio St., Chicago 11, Ill. has outlined the scope of its engineering activities in a new brochure which is free on request.

The company offers engineering, research, development, design, and testing facilities, all of which are pictured and described in the booklet.

WINDINGS AND COILS

Jeffries Transformer Company, 1710 E. 57th St., Los Angeles 58, California has issued a comprehensive bulletin illustrating its line of typical coils and windings.

The publication covers applications, manufacture, conductivity and resistivity, complete magnet wire characteristics table, tables on temperature

coefficient of resistance, current, h.p., kw. and kva., etc.

TV TRANSFORMER REPLACEMENTS

Application data on 38 new television transformer replacements is included in three bulletins, 485, 486, 487, just issued by Chicago Standard Transformer Corp., Addison and Elston Streets, Chicago 18, Ill.

The new Stancor replacements include 23 power transformers, 8 vertical output transformers, 5 width and linearity controls, 1 deflection yoke, and 1 filter choke. The power transformers are replacements for Motorola, Philco, RCA, Zenith, Silvertone, and other companies' original components.

RECTIFIER HANDBOOK

The Rectifier Division of Sarkes Tarzian, Inc., Bloomington, Ill. is now offering copies of its new, revised "Selenium Rectifier Handbook."

The 72-page book includes a revised selenium rectifier replacement guide and treats the different types of selenium rectifiers in some detail. Suggestions for applications and engineering data complete the book. The price is \$1.00 a copy.

MICROPHONE CHART

Since microphone sensitivity ratings are often specified in different systems, Shure Brothers, Inc. 225 W. Huron St., Chicago 10, Ill. is offering a "Microphone Sensitivity Conversion Chart" and explanatory guide.

The easy-to-read nomograph shows the relationship between open-circuit voltage response, open-circuit power response, and the RETMA sensitivity rating. The chart is designed for use by those engaged in buying, selling, installing or using microphones. Relative ratings can be determined in a few seconds. Copies of the chart are available on request.

ELECTRAN TRANSFORMERS

The Electrnan Manufacturing Co., 1901 Clybourn Ave., Chicago 14, Ill. has issued a 6-page folder which illustrates and describes its line of custom-made transformers, reactors, chokes, special windings, and electronic devices.

The folder incorporates a check list for those considering electrical or electronic components. Please specify Bulletin No. 55R when writing for this publication.

WIRE DATA

Columbia Wire & Supply Co., 2850 Irving Park Road, Chicago 18, Ill. has

COMMUNICATIONS RECEIVERS



Contains All Components

COMPLETE KIT—This kit is complete with every part necessary to assemble into a finished receiver, including tubes and cabinet. Chassis is punched and marked. Mount the parts, wire it, align it and you have a fine receiver of commercial appearance, that can't be beat for 3 or 4 times the price. Parts layout, schematic diagram and alignment instructions are supplied.

Shpg. weight 45 lbs. Shipped express only. F.O.B. Chicago and subject to change without notice.

SPECIAL Complete Kit

59⁵⁰ KIT PRICE EACH

YAGI TV ANTENNAS

Camburn (types VB-4 (Channel 4) and VB-5 (Channel 5)) at way below the regular price. Either type only. **\$4.95**

Cut them shorter for 2 meters if you don't need them for TV.

Write for new **FREE Radio Surplus Catalog—JUST OFF THE PRESS!**

BOULEVARD ELECTRONICS, INC.

Mail Order Address:
1229 W. Washington Blvd., Chicago, Ill.
Store Address: 4054 W. Belmont Ave., Chicago, Ill.
RADIO AND TELEVISION SUPPLIES

STOP

VOLUME CONTROL NOISE!



New 6 oz. Spray Can

Net to Servicemen **\$2.25**



CONTAINS AMAZING NEW PERMA-FILM

- ★ **CLEANS!** . . . dirt and oxidation immediately on contact.
- ★ **LUBRICATES!** . . . one drop eliminates scratch, hum and noise.
- ★ **PROTECTS!** . . . assures continued top performance.



Perfect Contact Restorer—cleans & restores volume controls, band switches, push button assemblies, electrical contacts. **NO NOISE** is not a carbon tet solution.



2 oz. bottle. Net to Servicemen **\$1.00**

Available in 8 oz. bottles and quart cans. Nearest distributor—or write

ELECTRONIC CHEMICAL CORP.

813 Communipaw Ave., Jersey City 4, N. J.

issued a 36-page catalogue which lists the company's basic and well as new wire items.

Designed to provide complete data for jobbers and manufacturers, this illustrated catalogue is available without charge.

PRINTED CIRCUIT DATA

Centralab, Division of Globe-Union, Inc., 900 E. Keefe Ave., Milwaukee 1, Wis. is now offering a new "Printed Electronic Circuit Guide," No. 3.

This 16-page brochure contains manufacturers' listings showing the usage of various printed circuits, circuit schematics showing printed circuit replacement of standard components, and a catalogue of printed circuits now available in the company's line.

TRANSISTORIZED CIRCUITS

P. R. Mallory & Co., Inc., North Tarrytown, N. Y. has issued two new booklets of interest to transistor engineers.

The booklet, "Power Requirements for Transistor Circuits," is an 8-page bulletin written by the chief engineer of the company's battery division.

The other publication provides technical information on the firm's mercury cells and batteries for transistor circuit applications. This 6-page bulletin describes and pictures the units in the company's line designed especially for applications involving limited space and extremes in operating conditions.

Either or both of these publications are available on request. —30—

PHOTO CREDITS

Page	Credit
31 (right) Westinghouse Electric Corp.
35 Stanford Research Institute
36 (left) Zenith Radio Corporation
36 (second from left) Hallicrafters Company
36 (center), 46 Radio Corporation of America
36 (second from right) Sparks-Withington
36 (right) Stewart-Warner Corporation
43 Tele-Beam Industries
44 (top) Altec-Lansing
44 (center) Cornell-Dubilier
44 (bottom) Heath Company
55 Allen B. Du Mont Laboratories
64 Universal Radio DX Club
104 Council of Radio & Television Service Associations

ERRATA

In the article "A Transistorized Light-Beam Communications System" which appeared in the May issue, the emitter-current limiting resistor in Fig. 1 is shown as a 15,000 ohm unit. This value should be 1500 ohms.

Since publication of the article "Community TV" in our May issue, we have been informed that the community TV system in Reno will use single-channel amplifier strips throughout, employing automatic gain control at every third amplifier, rather than broad-band amplifiers.

In addition, the total cost of the Williamsport, Pa. operation was over a quarter of a million dollars rather than \$31,000.

You Can Become an ELECTRICAL ENGINEER with a Bachelor of Science Degree IN 36 MONTHS



Major in Electronics or Power at Milwaukee School of Engineering

Everyone knows the tremendous opportunities ahead in electrical engineering. The expanding field of color television alone is one example. In addition to the demand for engineers, thousands of engineering technicians are needed. The Milwaukee School of Engineering can prepare you to become an engineer in 36 months or an engineering technician in 12 to 18 months. It'll pay you to look into it today. No obligation.

Technician and Service Courses — 12 to 18 months

In 12 months you can be a radio technician. An additional 6-month course qualifies you as a radio-television technician with an Associate in Applied Science degree. Or you can earn an industrial electronic technician certificate in 12 months.

These technician courses form the first third of the program leading to a B.S. Degree in Electrical Engineering. Twenty-one subjects in electronics, electronic engineering, and electronic design in this course.

Also offered are: radio-television service course (12 mos.); electrical service course (6 mos.); general preparatory and refresher course (3 mos.).



Terms open July, September, January and April

Faculty of specialists — 50,000 former students — Annual enrollment from 48 states and 23 foreign countries — Non-profit institution — 51st year of service — Course approved for veterans — Residence courses only.

MILWAUKEE SCHOOL OF ENGINEERING

TEAR OUT AND MAIL TODAY

MILWAUKEE SCHOOL OF ENGINEERING
Dept. RN-754, 1025 N. Milwaukee Street
Milwaukee 1, Wisconsin

Send me Free illustrated booklet on opportunities in Electrical Engineering or Free illustrated booklet on careers in Radio-TV.

I am interested in _____ (name of course)

Name _____ Age _____

Address _____

City _____ Zone _____ State _____

If veteran, indicate date of discharge _____

DIAMONDS OR RHINESTONES?

How many times have you been fooled by cheap imitation jewelry (or tubes) that looked like the "real" thing?

Too often cheap prices and extravagant claims have fooled the buyer into purchasing these imitations, instead of the genuine article.

Barry Electronics sells First Quality, Fully Guaranteed, individually boxed, Standard-Brand tubes. Our tubes do not have to be "set or meter checked.". They are from original, sealed cartons from the five leading tube manufacturers.

Cheap imitations such as seconds, rewashed bargains, and off-brands result in unnecessary call backs, expenses, and loss of customer good will.

You can place your confidence in our New, First Quality, fully-guaranteed STANDARD-BRAND tubes.

ASK FOR FREE NEWS BULLETIN AND HANDY-ORDER FORM

Tube Orders Over \$25.00, with full remittance, PREPAID to you in U.S.A.

RECEIVING TUBES

Type	Net	Type	Net	Type	Net
0A2	.95	6AX5GT	1.25	7B8	.75
0B2	.85	6B8	.75	7C4	.75
0B3/VR90	.82	6BA6	.70	7C5	.65
0C3/VR105	.91	6C5	.74	7D7	.70
0D3/VR150	.80	6DE6	.72	7E7	.65
0Z4/0Z4A	.55	6BF5	.84	7F8	1.25
1A7GT	.77	6B6G	1.39	7H7	.70
1B3GT	.90	6BH6	.85	7H7	.75
1B27	11.50	6BJ6	.85	7J7	.70
1W5GT	.77	6BK5	.95	7K7	.70
1L4	.60	6BK7A	1.15	12A7B	.85
1L6	.95	6BL7GT	1.20	12A7T	1.05
1LA6	1.10	6BN6	1.20	12AUG	.65
1L8	1.10	6B6GT	1.27	12A7U	.80
1LN5	1.10	6RQ7A	1.23	12AV8	.55
1N5GT	.95	6DX7GT	1.25	12AV7	1.00
1K4	.95	6B7G	1.20	12B6G	.68
1R5	.75	6B27	1.28	12A4A	.70
1S5	.75	6C4	.56	12A7	.80
1T4	.75	6C6	.50	12A7	1.75
1U4	.75	6C8E	.75	12A7T	.92
1U5	.70	6C6A	1.80	12B4	.98
1V	1.03	6CLG	1.10	12BA6	.70
1X2	.80	6C16	2.10	12B6G	.75
1X2B	.80	6D6	.75	12B8B	.72
1Z2	3.25	6F4	3.30	12R7	1.00
2X2	.55	6F5	.55	12R7T	1.05
3A4	.59	6F5GT	.68	12R27	.10
3B7	.39	6F6	.70	12S7	.60
3Q4	.89	6F6G	.80	12S7S	.70
3Q5GT	.90	6FRG	.85	12S7	.80
3S4	.75	6G6G	.85	12S7	.83
3L4	.90	6H1	.92	12S7	.85
3V4	.75	6H1 (RCA)	4.50	12S7	.85
5AW4	1.50	6J5	.55	12S7GT	.65
5R4GY	1.50	6J6	.80	12S7GT	.85
5U4G	.59	6J7	.70	12S7GT	.70
5V4G	.97	6KGT	.65	12S7	.80
5W4G	.80	6K7	.60	12S7GT	1.10
5X4G	.85	6L6	1.20	12T7	.95
5Y3GT	.48	6L6A	1.10	19B6GG	2.05
5Z3	.75	6L6M	1.45	19T8	1.10
6A6GT	1.10	6L7	.80	25B06GT	1.35
6B4	.70	6M7M	.70	25W4GT	.70
6B7	.95	6O7GT	.80	25Z5	.75
6AC7	1.14	6P7M	.98	25WGT	.64
6AD7G	1.85	6S4	.63	26A6	1.75
6AF4	1.39	6SA7	.69	26A7GT	2.50
6AG5	.78	6SC	.88	6D7GT	.65
6AG7	1.10	6SD7GT	.66	26D6	1.75
6AHSGT	.89	6SG7	.66	28D7	1.55
6AH6	.93	6SH7	.98	28D7	1.55
6AL5	1.30	6S7	.65	35D5	.72
6AK5	.80	6SK7	.69	35C5	.72
6AK5-W	1.50	6SL7GT	.65	35L6GT	.70
6AK6	.98	6SN7GT	.75	35L6GT	.70
6AL5	.60	6RQ7	.63	35Z3	.50
6AN4	1.60	6T4	1.35	35Z5GT	.70
6AN5	3.65	6T8	.99	50R5	.70
6AQ5	.72	6U8	.75	50R5	.70
6AQ6	.73	6V3A	1.30	50R5	.70
6J5S	.75	6W6GT	.67	50LFGT	.70
6AS6	2.35	6W6GT	.82	6U	.66
6AS7G	3.75	6W6GT	.82	6U	.66
6AT6	.58	6X5GT	.52	81	.55
6AU6GT	1.80	6XK	1.00	84V	1.15
6AUSGT	1.15	6XK	.75	11Z73	.75
6AU6	.85	7A8	.68	11Z76	1.00
6AV5GT	1.10	7B8	.75	16R0	4.50
6AV6	.57	7B8	.75	56A2	1.00
6AX4GT	.84	7D7	.76		

SPECIAL PURPOSE TUBES

Write for our complete listing of Xmtg., Industrial, Special-Purpose and Crystal Diodes. We stock over 2,000 types at excellent prices.

Above is only a partial listing of our huge stock. Types not listed may be ordered at approx. the same savings. Many new special purpose types in stock.

AUTHORIZED DISTRIBUTORS

CBS-HYTRON EIMAC WESTINGHOUSE

ORIGINAL JOBBERS' BOXED TUBES

IN STOCK—LATE DATES, at WHOLESALE PRICE LEVELS!

TWO-COLORED TUBE CARTONS, with new Safety Partitions. Prevents Tube Breakage. This Super-Gloss Red and Black Carton is the Most Distinctive Box Available Today! Minimum: 100 any one size. Quantity prices on request.

SIZE	EACH
Miniature (6AU6, 6AL5, etc.)	\$0.1
GT (6SN7, 6W4, etc.)	.0125
LARGE GT (1B3, 6BQ6G, etc.)	.015
LARGE G (5U4G, 6B6GG, etc.)	.02

Terms: 25% with order, balance C.O.D. All merchandise guaranteed. F.O.B., N.Y.C. PHONE: RECTOR 2-2562

BARRY ELECTRONICS CORP.
136-F LIBERTY ST. N. Y. 6, N. Y.

INDEX OF Advertisers

JULY 1954

While every precaution is taken to insure accuracy, we cannot guarantee against the possibility of an occasional change or omission in the preparation of this index.

ADVERTISER	PAGE	ADVERTISER	PAGE
Aaron Electronics	123	Lafayette Radio	119
Acro Products Co.	86	Lampkin Laboratories, Inc.	115
Aermotor Co.	109	Lapirow Bros.	111
Airex Radio Corp.	100	Leotone Radio Corp.	115
All Channel Antenna Corp.	76	Mallory & Co., Inc., P. R.	4th cover, 67
Allied Radio Corp.	13	Mattison Television & Radio Corp.	23
American Microphone Co.	107	McGraw-Hill Book Co.	90
American Television & Radio Co.	121	Miles Reproducer Co., Inc.	119
Amplifier Corp. of America	113	Milwaukee School of Engineering	127
Arkay Radio Kits, Inc.	116	Moss Electronic Distributing Co., Inc.	80, 81
Army Surplus Outlet	121	Musical Masterpiece Society, Inc., The	93
Arrow Sales, Inc.	82	National Company	10, 11
Ashe Radio Co., Walter	65	National Electronics of Cleveland	125
Associated Industries	122	National Radio Institute	3
Atlas Sound Corp.	125	National Schools	9
Audel Publishers	123	New Jersey Television Supply Co.	123
Baltimore Technical Institute	122	Onan & Sons, Inc., D. W.	117
Barry Electronics Corp.	128	P-A-R-T-S, Inc.	122
Bell Telephone Laboratories	24	Pailley Supply Co.	111
Berlant Associates	28	Peak Electronics Co.	104
Bonica Newsreel Club	122	Pickering & Company, Incorporated	6
Boulevard Electronics, Inc.	127	Platt Electronics Corp.	88
Burstein-Applebee Co.	124	Precision Electronics	121
CBS-Hytron	19	Premier Radio-TV Supply	84
Candler System Co.	76	Prentice-Hall, Inc.	96
Cannon Electric Company	78	Progressive "Edu-Kits", Inc.	117
Capitol Radio Engineering Institute	25	Quietrol Company	98
Centralab	21, 68, 75, 113	Q. T. Sales	122
Century Electronics Co.	126	RCA Institutes, Inc.	29, 116
Channel Master Corp.	27	R W Electronics	129
Cincinnati Ventilating Co., The	114	Radiart Corporation, The	22
Cleveland Institute of Radio Electronics	77	Radio Corporation of America	23
Collins Audio Products Co., Inc.	85	Radio Craftsmen, Inc., The	20
Columbia Electronics Corp.	89	Radio Television News Book Service	87
Columbia Electronics Sales	205	Rad-Tel Tube Co.	79
Communications Company, Inc.	18	Raytheon Manufacturing Company	2nd Cover
Communications Equipment Co.	94	Rider Publishers, Inc., John F.	108
Concord Radio	120	Rinehart & Co., Inc.	94
Corona Radio & T.V. Co.	76	Sams & Co., Inc., Howard W.	70
Coyne Electrical School	89, 93	Shure Brothers, Inc.	101
De Vry Technical Institute	5	Sprayberry Academy of Radio	3rd Cover
Delco Radio Corporation	63	Stan Burn Radio & Electronics Co.	116
Editors & Engineers, Ltd.	120	Standard Surplus	91
Eitel-McCullough, Inc.	122	Steve-El, Electronics Corp.	113
Electronic Chemical Corp.	127	Stuart Electronic Distributors	97
Electronic Instrument Co., Inc. (EICO)	30, 95, 101	Sun Parts Distributors, Ltd.	117
Electron Tube Wholesalers, Inc.	111	Supreme Publications	83
Electro-Voice	12	Sylvania Electric Products, Inc.	7
Fair Radio Sales	95	"TAB"	130
Fairchild Recording Equipment Corp.	105	Telephone Engineering Co.	86
Fisher Radio Corporation	15	Television Communications Institute	119
G & G Radio Supply Co.	102	Teltron Electronics Co.	86
G & H Wood Products Co.	94	Terado Company	106
G. L. Electronics, Inc.	112	Transamerica Electronics Corp.	99
General Electric Co.	16, 17	Transcircuits	114
General Electronic Dist. Co.	119	Triplett	8
Goodheart, R. E.	112	Tri-State College	105
Grantham School of Electronics	114	Tung-Sol Electric, Inc.	125
Greenlee Tool Co.	115	Turner Company, The	114
H & H Electronic Supply, Inc.	105	United Radio Co.	126
Harjo Sales Co.	93	U.S. Crystals	118
Harvey Radio Company, Inc.	97	Valparaiso Technical Institute	103
Heath Company	71, 72, 73, 74	Walsco Electronics Corporation	69
Henshaw Radio Supply	103	Washtek Service Co.	76
Hughes Research and Development Laboratories	110	Western Electronics Co.	103
Indiana Technical College	126	Western Television Institute	95
Instructograph Company	114	Wholesale Radio Parts Co., Inc.	101
International Rectifier Corporation	92	Windsor Electronic Tube Co.	109
JFD Manufacturing Co.	89	World Radio Laboratories	103
J. J. Glass Electronics Co.	122	Zingo Products	86
JSH Sales Co.	124		
Jones & Laughlin Steel Corporation	14		

Classified

Rate 50c per word. Minimum 10 words

RADIO ENGINEERING

COMPLETE radio, electronics theory & practice: television; broadcasting; servicing; aviation; marine, police radio. 12 or 18 months. Catalog. Valparaiso Technical Institute, Dept. N, Valparaiso, Ind.

FOR SALE

DIAGRAMS—Radio \$1.00; record changers, recorders \$1.25. Television with service data \$2.00. Where model unknown, give part numbers. Kramer's Radio Service, Dept. S53, 36 Columbus Ave., New York 23, N. Y.

TAPE Recorders, Tapes, Accessories. Unusual Values. Dressner, 624-R East 20th St., N.Y.C. 9.

FREE: Get our monthly electronic lists. Dick Rose, Everett, Wash.

CODE practice oscillators New, guaranteed, \$4.00 postpaid. Stout, 2241 E. Broadway, Muskegon, Michigan.

TELEVISION Receivers, \$30 up. W4API, 1420 South Randolph, Arlington 4, Virginia.

TV-FM antennas. All types including UHF. Mounts, Accessories. Lowest prices. Wholesale Supply Co., Dept. H, Lunenburg, Mass.

AN/Apr-4, other "APR-" "ARR-" "TS-" "LE-" ARC-1, ARC-3, ART-13, everything surplus; Tubes, Manuals, Laboratory equipment. Describe, price in first letter. Engineering Associates, 434 Patterson Rd., Dayton 9, Ohio.

5,000—615 TUBES, (Army). Rough but new, tested. 5 for \$1, postpaid. Guaranteed. Holt Radio, 10659 Magnolia, North Hollywood, Calif.

CUSTOM made high-fidelity speaker enclosures and utility cabinets. Wilmington Cabinet Company, Box 394, Wilmington, North Carolina.

MANUFACTURERS Surplus. 60 note triple stacked shunt keying mechanisms. Octave wired isolating resistor to each palladium contact. 2 types, Great. 16'—8'—4'. Swell, 8'—4'—2 1/2'. Make your own electronic organ with these basic units. \$10.00 each. Minshall-Estey Organ, Inc., P.O. Box 537, Brattleboro, Vermont.

ALUMINUM tubing, angle and channel, plain and perforated sheet. Willard Radcliff, Fostoria, Ohio.

HEARING Aids. Zeniths, Western Electrics. Reconditioned. Make miniature transmitters or receivers. Complete with ear piece and cords, \$16.00 each. Gloria Davis, 12 Oak Drive, Great Neck, L. I., N. Y.

SPECIAL on tape recorders and tape. Brush "Sound Mirror" tape recorder model No. BK 442—brand new (sealed carton). \$129.75. Regularly priced at \$259.50. Brush 1200' plastic tape on 7" metal reels—\$2.50 each. Regularly priced at \$5.50. Aseo Sound Corp., 115 West 45 Street, New York, N. Y.

VanSICKLE displaying all National Receivers, offers big trades, easy terms. W9KJF, 1320 Calhoun, Ft. Wayne, Indiana.

TOWER TRUCK Telescoping tower for TV reception surveys. Mounted on 4 wheel drive army personnel carrier. Extends to 70 feet. Truck and tower \$300.00 F.O.B. M & M T. V. Co., 7 Maple Ave., Morristown, N. J.

COMPLETE speaker reconing service, inventories over \$500.00 distributor's cost; closeout \$200.00. Selling first come first serve basis. Radio Laboratories, 215 King Street, Charleston 5, S. C.

TELEVISION sets \$22 up. Jones TV, 1115 Rambler, Pottstown, Pa.

"DIAGRAMS for repairing radios \$1.00. Record-Changers \$1.50. Television \$2.00. Give Make, Model. Diagram Service, 672-RN, Hartford 1, Connecticut."

WANTED

WILL buy all ART-13/type T-47A \$200.00. ART-13/type T-47 \$150.00. BC-348 unmodified \$65.00. BC-348 modified \$50.00. APN-9 \$200.00. ARC1 Radio \$200.00. BC-312 Receiver \$60.00. BC-342 Receiver \$60.00. Ship Via Express C.O.D., Subject to inspection to H. Finnegan, 49 Washington Ave., Little Ferry, N. J.

WANTED: Selsyns type 3—\$40.00 each; Size 1 and other sizes will advise; Torque Units, Amplidyne, Autosyns, Tubes. Subject to inspection. Electro, 50-58 Eastern Ave., Boston 13, Mass.

TUBES wanted, Highest prices paid. 1P21, 2C40, 3B24, 3C22, 3C45, 3D21A, 3E20, 4C35, 5C22, 304TH & TL, W.E. 417A, 450TH & TL, 715B & C, 723AB, 726B & C, 807, 810, 813, 829B, 832A, 5691, 5692, 5693. All 2J-2K & 4K Series, Sub-miniature & receiving types. Send your List. Phone Rector 2—6245. "Tab", 111 Liberty St., N. Y. 6, N. Y.

"TELETYPEWRITERS, tape send-receive or receive only, Model 14, any quantity or condition. Box 540, Radio & Television News."

CORRESPONDENCE COURSES

USED correspondence Courses and Books sold and rented. Money back guarantee. Catalog free. (Courses bought.) Lee Mountain, Pisgah, Ala.

PASS amateur theory exams. Check yourself with sample FCC-type questions & novice & general class examinations. All for only 50c. American Electronics, 1203 1/2 Bryant Ave., New York 59, N. Y.

USED Correspondence Courses and Educational books Bought, Sold, Rented. Catalog Free. Educational Exchange, Summerville, Ga.

MISCELLANEOUS

ALL makes speakers repaired. Amprite Speaker Service, 70 Vesey St., New York City 7.

BUILD your own electronic organ or miniature electronic brain. Jim Kirk, W6DEG, 1552 Church St., San Francisco 14, Calif.

TEST Equipment Repaired and calibrated by factory staff. All makes. Solar, Simpson, Triplett, Heath, etc. Immediate service. Douglas Instrument Laboratory, 176 Norfolk Avenue, Boston 19, Mass.

POPULAR ELECTRONICS Watch for August RADIO & TELEVISION NEWS

A SWEET OSCILLOSCOPE DEAL

ASB-7 Radar Indicator Unit: For conversion to test scope or for use as modulation monitor. Has standard test-scope CR tube, H Cent, V Cent, Brill, Foc, Gain, and range selection switch. External power source was used. Tubes: 4-6AC7, 3-6H6, 1-5B1P. Condition good. NEW. \$9.95

ASB RECEIVER: Freq. range: 510-555 MC. With tubes. New. Reduced to \$11.95

ASB TRANSMITTER: Freq. range: 510-555 MC. Complete with tubes. Only 4.95

ASB POWER SUPPLY: New 4.95

ASB ANTENNA SWITCHING UNIT. New. Hot buy! 2.95

BC-929—Contains power supply 110 V. 400 cycles, has 7 tubes such as 3CP1, brand new, complete with tubes. Each \$14.95

ARC-5/R-28 2 MTR RCVR—2 meter superhet. absolutely one of the BEST available today! Tunes from 100 to 156 mcs. in four crystal channels. (Easily converted to continuous tuning.) Complete with 10 tubes \$17.95

PP-51/APQ9—Rectifier Power Supply. Contains 4 each 5R4 tubes; 2 each 1 mfd. @ 1500 VDC and 2 each 4 mfd. @ 1000 VDC oil-filled condensers plus other parts. Brand new in original boxes. \$6.95 ea.

T-23/ARC-5 Transmitter for above. 100-156 MC. Complete w/Tubes. Used exc. \$29.95

RL-42 Reversible beam rotator motor 8500 rpm, attached to gear reduction box which drops speed to 120 rpm. \$1.95

2SVDC—Used

BEAM ANTENNA SELSYN TRANSMITTER and indicator, per set \$12.00

Low Freq. Crystals—FT 241 A for SSB, lattice filter, 1/2" spc. 54th harm channels listed by fund. Fractions omitted.

See previous Radio-TV News Issues for frequencies

49c each 10 for \$3.00

Command Equipment (274N-ARC5, ATA)

	As Is	Exc. Used
190-550 KC	\$14.95
1.5-3 mc	14.95
3-6 mc	5.95
6-9 mc	5.95
3-Rec. Back	1.50
3-Control Head	2.50
1C 458 Transmitter	4.95
459 Transmitter	7.95
456 Modulator	1.95

Hundreds of items in stock. WRITE FOR NEW BULLETIN AND PRICES. Shipments F.O.B. warehouse. 20% Deposit on orders. Minimum order \$5.00. Illinois residents, add regular sales tax remittance. Prices subject to change without notice.

R W ELECTRONICS

Dept. N, 2430 S. Michigan Ave.
Chicago 16, Ill.
PHONE: Calumet 5-1281-2-3

FOR YOUR CONVENIENCE
New "RW" West Coast Representative!
ELECTRONICS TRADING POST
1632 Venice Blvd. Los Angeles, Calif.
Phone: Richmond 7-4104

BROADCAST BAND—DIRECTION FINDER and AERO



Ideal for Use in Boats, etc.

MN-26-C Remote Controlled Navigational Direction finder and communications receiver. Manual DF in any one of three freq. bands. 150 to 1500 KC. 24 V. Self contained dynamotor supply. Complete installation, including receiver, control loop, azimuth control. Left-Right Indicator, plugs, loop transmission line and flex. shafts. oper. & main. manual.

ALL UNITS BRAND NEW EXCEPT CONTROL BOX \$69.50
MN-26-V 150 to 325 KC. 325 to 695 KC. 3.4 to 7 megacycles, comp. installation. 49.50
MN-26-C alone, like new. 24.95
MN-26-V as is less tubes. 4.95
MN-20-E Loop. Brand New. 6.95
MN-52 Crank drive. New. 2.50
MN-26LB Receiver exc. freq. 150-1250 KC. 2.9-6mc. 59.50

T-26 Telephone chest unit with F-1 Western Electric Transmitter \$1.59
HS-33 Low Impedance Headset, exc. \$2.98 new \$5.45
HS-23 Headset, used \$1.89 new 4.50
HS-30, miniature headset. Used \$1.49, new 2.49
Throat Mike—T-30—new .98



Lip Mike—Navy Type new .98
CW-49505 High Impedance Headset Complete with headband. Used 98c
T-45 Lip Mike. New \$1.75
RS38 Navy type carbon mike—exc. ea. 2.45
TS Handset with F-1 unit. 2.45
J-38 or J-47 Telegraph key. each 98c
5BP1, 5FP7, 4AP10, 5AP1 \$2.00
304TL 3.95 ea.

OIL CONDENSERS—8 mfd. oil condensers @ 600 VDC 98c

ARB NAVY RECEIVER—190 KC to 9 MC. Used, exc. \$19.95

BC-375 TRANSMITTER with TU5 TUNING UNIT—exc. \$49.50

AN/APR5A Airborne superhet radar search rec. Freq. range 1000 to 3000 MC. Rec. has a 10 MC IF band width operating from 80/115 VAC, single phase 60 to 2600 cps. and one amp. at 26 VDC—complete with tubes. \$250.00

AN/APT5 TRANSMITTER—operates over a freq. of 300 to 1400 MC; output 30 Watts. The carrier freq. is noise-modulated with effective random noise freq. up to 2 MC. Complete with tubes \$99.50

I-122 SIGNAL GENERATOR RF signal 15 to 25 MC and 90 to 125 MC; modulated at 400 cps. or 625 cps. Power Supply 100 to 135 VAC, 25 to 60 cps. NEW \$49.50

Spare parts kit for above (new) \$9.95

BC669 Crystal Controlled Radio Receiver and 50 Watt Transmitter—freq. range 1700 to 1400 KC—complete with tubes, new \$89.50
Used, exc. \$69.50 (F.O.B. Calif.)

**INDIVIDUALS WRITE ON YOUR
HEADER FOR POWER
RECTIFIER CATALOG**

**SELENIUM
RECTIFIERS**

We specialize in Rectifiers and Power supplies to specifications. Immediate delivery.

Current (cont.)	18/14	36/28	54/40	130/100
Volts	1.40	2.40	3.80	5.50
1AMP	1.40	2.40	3.80	5.50
2AMP	2.10	3.00	4.50	10.50
4AMP	4.20	7.50	11.50	25.25
6AMP	4.20	9.00	13.50	33.00
10AMP	6.60	12.75	20.00	42.50
12AMP	8.20	16.25	22.50	46.00
13.2AMP	13.25	25.50	31.00	73.50
24AMP	16.25	32.50	45.00	86.50

Rectifier & Transformer 115V/60 cy up to 14VDC at 12 amps.....\$19.98
up to 28VDC at 4 amps.....14.98
up to 28VDC at 12 amps.....29.98
up to 28VDC at 24 amps.....63.98
up to 28VDC at 30 amps.....73.00

C "TAB" fast delivery SPECIAL \$2.00

**HIGH CURRENT
PWR SUPPLIES**

Variable 0-28VDC. Completely Built. Ready to Go. Full Wave Selenium Rectifier, Transformer, Variac, Volt & Amp Meters, Switch, Terminals & Fuse. In Hwy Div. Stock Cabinet. Standard 115V 60 cy input. 220V to order. Write.

Stock Number	Rating	With Transformer
T28V5A	0-28VDC	5 Amp.....\$47.75
T28V12A	0-28VDC	12 Amp.....89.00
T28V24A	0-28VDC	24 Amp.....129.50
T28V50A	0-28VDC	50 Amp.....239.50
T816 0-8	0-16V	Variable 0-10 Amps. Rated 6 or 12VDC continuous metered.....\$35

RECTIFIER XFMR'S

Primary 115V 60 Cy Secondary 0-12-18-24-36V

4 Amp	5	8.75	\$15.75
12 Amp	5	16.75	\$29.95
24 Amp	5	33.75	\$69.95
18 VDC only	2	13.00	\$23.50
2X 12Volts/2A or 12V/4A or 24V/2AMP		\$3.99	3/510/12/336

RECTIFIER CHOKES
4 Amp .07 H.V. Ohm.....\$7.95
12 Amp .07 H.V. Ohm.....\$19.95
24 Amp .04 H.V. .025 Ohm.....29.95

DC POWER SUPPLY
Variable DC Power Supply. Full Wave Rectification. 6000Mfd filter. Condenser, fused. Rated 6.3V or 12.6V at 2 amp. Operates 15V/60 Hz. Model 2DCF.....\$12.98
As above except 4 amp. Model 4DC.....\$20.98

CIRCUIT BREAKERS

Heinmann Main Break 220, 3, 7, 9, 12, 20, 30, 35, 40, 80, 180
Sq. D. CH Toggle Sw. Breaks. 10, 15, 20, 25, 30, 35, 40, 50, 53, 59, 63, 70, 80, 90, 100, 125, 150, 175, 200, 225, 250, 275, 300, 350, 400, 450, 500, 550, 600, 650, 700, 750, 800, 850, 900, 950, 1000, 1100, 1200, 1300, 1400, 1500, 1600, 1700, 1800, 1900, 2000, 2200, 2400, 2600, 2800, 3000, 3200, 3400, 3600, 3800, 4000, 4200, 4400, 4600, 4800, 5000, 5200, 5400, 5600, 5800, 6000, 6200, 6400, 6600, 6800, 7000, 7200, 7400, 7600, 7800, 8000, 8200, 8400, 8600, 8800, 9000, 9200, 9400, 9600, 9800, 10000, 11000, 12000, 13000, 14000, 15000, 16000, 17000, 18000, 19000, 20000, 22000, 24000, 26000, 28000, 30000, 32000, 34000, 36000, 38000, 40000, 42000, 44000, 46000, 48000, 50000, 52000, 54000, 56000, 58000, 60000, 62000, 64000, 66000, 68000, 70000, 72000, 74000, 76000, 78000, 80000, 82000, 84000, 86000, 88000, 90000, 92000, 94000, 96000, 98000, 100000, 110000, 120000, 130000, 140000, 150000, 160000, 170000, 180000, 190000, 200000, 220000, 240000, 260000, 280000, 300000, 320000, 340000, 360000, 380000, 400000, 420000, 440000, 460000, 480000, 500000, 520000, 540000, 560000, 580000, 600000, 620000, 640000, 660000, 680000, 700000, 720000, 740000, 760000, 780000, 800000, 820000, 840000, 860000, 880000, 900000, 920000, 940000, 960000, 980000, 1000000, 1100000, 1200000, 1300000, 1400000, 1500000, 1600000, 1700000, 1800000, 1900000, 2000000, 2200000, 2400000, 2600000, 2800000, 3000000, 3200000, 3400000, 3600000, 3800000, 4000000, 4200000, 4400000, 4600000, 4800000, 5000000, 5200000, 5400000, 5600000, 5800000, 6000000, 6200000, 6400000, 6600000, 6800000, 7000000, 7200000, 7400000, 7600000, 7800000, 8000000, 8200000, 8400000, 8600000, 8800000, 9000000, 9200000, 9400000, 9600000, 9800000, 10000000, 11000000, 12000000, 13000000, 14000000, 15000000, 16000000, 17000000, 18000000, 19000000, 20000000, 22000000, 24000000, 26000000, 28000000, 30000000, 32000000, 34000000, 36000000, 38000000, 40000000, 42000000, 44000000, 46000000, 48000000, 50000000, 52000000, 54000000, 56000000, 58000000, 60000000, 62000000, 64000000, 66000000, 68000000, 70000000, 72000000, 74000000, 76000000, 78000000, 80000000, 82000000, 84000000, 86000000, 88000000, 90000000, 92000000, 94000000, 96000000, 98000000, 100000000, 110000000, 120000000, 130000000, 140000000, 150000000, 160000000, 170000000, 180000000, 190000000, 200000000, 220000000, 240000000, 260000000, 280000000, 300000000, 320000000, 340000000, 360000000, 380000000, 400000000, 420000000, 440000000, 460000000, 480000000, 500000000, 520000000, 540000000, 560000000, 580000000, 600000000, 620000000, 640000000, 660000000, 680000000, 700000000, 720000000, 740000000, 760000000, 780000000, 800000000, 820000000, 840000000, 860000000, 880000000, 900000000, 920000000, 940000000, 960000000, 980000000, 1000000000, 1100000000, 1200000000, 1300000000, 1400000000, 1500000000, 1600000000, 1700000000, 1800000000, 1900000000, 2000000000, 2200000000, 2400000000, 2600000000, 2800000000, 3000000000, 3200000000, 3400000000, 3600000000, 3800000000, 4000000000, 4200000000, 4400000000, 4600000000, 4800000000, 5000000000, 5200000000, 5400000000, 5600000000, 5800000000, 6000000000, 6200000000, 6400000000, 6600000000, 6800000000, 7000000000, 7200000000, 7400000000, 7600000000, 7800000000, 8000000000, 8200000000, 8400000000, 8600000000, 8800000000, 9000000000, 9200000000, 9400000000, 9600000000, 9800000000, 10000000000, 11000000000, 12000000000, 13000000000, 14000000000, 15000000000, 16000000000, 17000000000, 18000000000, 19000000000, 20000000000, 22000000000, 24000000000, 26000000000, 28000000000, 30000000000, 32000000000, 34000000000, 36000000000, 38000000000, 40000000000, 42000000000, 44000000000, 46000000000, 48000000000, 50000000000, 52000000000, 54000000000, 56000000000, 58000000000, 60000000000, 62000000000, 64000000000, 66000000000, 68000000000, 70000000000, 72000000000, 74000000000, 76000000000, 78000000000, 80000000000, 82000000000, 84000000000, 86000000000, 88000000000, 90000000000, 92000000000, 94000000000, 96000000000, 98000000000, 100000000000, 110000000000, 120000000000, 130000000000, 140000000000, 150000000000, 160000000000, 170000000000, 180000000000, 190000000000, 200000000000, 220000000000, 240000000000, 260000000000, 280000000000, 300000000000, 320000000000, 340000000000, 360000000000, 380000000000, 400000000000, 420000000000, 440000000000, 460000000000, 480000000000, 500000000000, 520000000000, 540000000000, 560000000000, 580000000000, 600000000000, 620000000000, 640000000000, 660000000000, 680000000000, 700000000000, 720000000000, 740000000000, 760000000000, 780000000000, 800000000000, 820000000000, 840000000000, 860000000000, 880000000000, 900000000000, 920000000000, 940000000000, 960000000000, 980000000000, 1000000000000, 1100000000000, 1200000000000, 1300000000000, 1400000000000, 1500000000000, 1600000000000, 1700000000000, 1800000000000, 1900000000000, 2000000000000, 2200000000000, 2400000000000, 2600000000000, 2800000000000, 3000000000000, 3200000000000, 3400000000000, 3600000000000, 3800000000000, 4000000000000, 4200000000000, 4400000000000, 4600000000000, 4800000000000, 5000000000000, 5200000000000, 5400000000000, 5600000000000, 5800000000000, 6000000000000, 6200000000000, 6400000000000, 6600000000000, 6800000000000, 7000000000000, 7200000000000, 7400000000000, 7600000000000, 7800000000000, 8000000000000, 8200000000000, 8400000000000, 8600000000000, 8800000000000, 9000000000000, 9200000000000, 9400000000000, 9600000000000, 9800000000000, 10000000000000, 11000000000000, 12000000000000, 13000000000000, 14000000000000, 15000000000000, 16000000000000, 17000000000000, 18000000000000, 19000000000000, 20000000000000, 22000000000000, 24000000000000, 26000000000000, 28000000000000, 30000000000000, 32000000000000, 34000000000000, 36000000000000, 38000000000000, 40000000000000, 42000000000000, 44000000000000, 46000000000000, 48000000000000, 50000000000000, 52000000000000, 54000000000000, 56000000000000, 58000000000000, 60000000000000, 62000000000000, 64000000000000, 66000000000000, 68000000000000, 70000000000000, 72000000000000, 74000000000000, 76000000000000, 78000000000000, 80000000000000, 82000000000000, 84000000000000, 86000000000000, 88000000000000, 90000000000000, 92000000000000, 94000000000000, 96000000000000, 98000000000000, 100000000000000, 110000000000000, 120000000000000, 130000000000000, 140000000000000, 150000000000000, 160000000000000, 170000000000000, 180000000000000, 190000000000000, 200000000000000, 220000000000000, 240000000000000, 260000000000000, 280000000000000, 300000000000000, 320000000000000, 340000000000000, 360000000000000, 380000000000000, 400000000000000, 420000000000000, 440000000000000, 460000000000000, 480000000000000, 500000000000000, 520000000000000, 540000000000000, 560000000000000, 580000000000000, 600000000000000, 620000000000000, 640000000000000, 660000000000000, 680000000000000, 700000000000000, 720000000000000, 740000000000000, 760000000000000, 780000000000000, 800000000000000, 820000000000000, 840000000000000, 860000000000000, 880000000000000, 900000000000000, 920000000000000, 940000000000000, 960000000000000, 980000000000000, 1000000000000000, 1100000000000000, 1200000000000000, 1300000000000000, 1400000000000000, 1500000000000000, 1600000000000000, 1700000000000000, 1800000000000000, 1900000000000000, 2000000000000000, 2200000000000000, 2400000000000000, 2600000000000000, 2800000000000000, 3000000000000000, 3200000000000000, 3400000000000000, 3600000000000000, 3800000000000000, 4000000000000000, 4200000000000000, 4400000000000000, 4600000000000000, 4800000000000000, 5000000000000000, 5200000000000000, 5400000000000000, 5600000000000000, 5800000000000000, 6000000000000000, 6200000000000000, 6400000000000000, 6600000000000000, 6800000000000000, 7000000000000000, 7200000000000000, 7400000000000000, 7600000000000000, 7800000000000000, 8000000000000000, 8200000000000000, 8400000000000000, 8600000000000000, 8800000000000000, 9000000000000000, 9200000000000000, 9400000000000000, 9600000000000000, 9800000000000000, 10000000000000000, 11000000000000000, 12000000000000000, 13000000000000000, 14000000000000000, 15000000000000000, 16000000000000000, 17000000000000000, 18000000000000000, 19000000000000000, 20000000000000000, 22000000000000000, 24000000000000000, 26000000000000000, 28000000000000000, 30000000000000000, 32000000000000000, 34000000000000000, 36000000000000000, 38000000000000000, 40000000000000000, 42000000000000000, 44000000000000000, 46000000000000000, 48000000000000000, 50000000000000000, 52000000000000000, 54000000000000000, 56000000000000000, 58000000000000000, 60000000000000000, 62000000000000000, 64000000000000000, 66000000000000000, 68000000000000000, 70000000000000000, 72000000000000000, 74000000000000000, 76000000000000000, 78000000000000000, 80000000000000000, 82000000000000000, 84000000000000000, 86000000000000000, 88000000000000000, 90000000000000000, 92000000000000000, 94000000000000000, 96000000000000000, 98000000000000000, 100000000000000000, 110000000000000000, 120000000000000000, 130000000000000000, 140000000000000000, 150000000000000000, 160000000000000000, 170000000000000000, 180000000000000000, 190000000000000000, 200000000000000000, 220000000000000000, 240000000000000000, 260000000000000000, 280000000000000000, 300000000000000000, 320000000000000000, 340000000000000000, 360000000000000000, 380000000000000000, 400000000000000000, 420000000000000000, 440000000000000000, 460000000000000000, 480000000000000000, 500000000000000000, 520000000000000000, 540000000000000000, 560000000000000000, 580000000000000000, 600000000000000000, 620000000000000000, 640000000000000000, 660000000000000000, 680000000000000000, 700000000000000000, 720000000000000000, 740000000000000000, 760000000000000000, 780000000000000000, 800000000000000000, 820000000000000000, 840000000000000000, 860000000000000000, 880000000000000000, 900000000000000000, 920000000000000000, 940000000000000000, 960000000000000000, 980000000000000000, 1000000000000000000, 1100000000000000000, 1200000000000000000, 1300000000000000000, 1400000000000000000, 1500000000000000000, 1600000000000000000, 1700000000000000000, 1800000000000000000, 1900000000000000000, 2000000000000000000, 2200000000000000000, 2400000000000000000, 2600000000000000000, 2800000000000000000, 3000000000000000000, 3200000000000000000, 3400000000000000000, 3600000000000000000, 3800000000000000000, 4000000000000000000, 4200000000000

Boost your converter sales



The Mallory Concealed Converter—first on the market

Give Your Customers their choice

...with two Mallory converter styles

Mallory . . . and only Mallory . . . offers you both types of ALL-CHANNEL UHF CONVERTERS—one designed to fit inside any TV set and the other to be used on or beside any set.

The New Mallory '188' Concealed Converter is mounted inside the TV set . . . out of sight! All that shows is a clear plastic selector dial and switch. Installation is easy. A bracket and four screws are supplied to mount the unit on either side or at the top in wood cabinets. For plastic or metal cabinets, the converter may be mounted on the fiber-board rear enclosure.

Both the Mallory '188' and the Mallory '88' Cabinet Model give the same trouble-free performance, that has made Mallory the leading converter in every area since the start of UHF telecasting.



The Mallory Cabinet Converter—first on the market

No radiation problem! Mallory Converters contain specially designed components to prevent troublesome interference from radiation—a problem common to low quality converters which can ruin TV reception over a wide area.

Give yourself greater Converter Sales . . . By giving your Customers Their Choice of Mallory Converters.

MALLORY

CAPACITORS • CONTROLS • VIBRATORS • SWITCHES • RESISTORS
RECTIFIERS • POWER SUPPLIES • CONVERTERS • MERCURY BATTERIES

APPROVED PRECISION PRODUCTS

MALLORY & CO. Inc., INDIANAPOLIS 6, INDIANA